

**DESIGN GUIDE**

**BUILT-IN | INTEGRATED | WINE STORAGE | UNDERCOUNTER**





## CONTENTS

<b>Built-In Refrigeration</b>	<b>4</b>
<b>Integrated Refrigeration</b>	<b>31</b>
<b>Wine Storage</b>	<b>50</b>
<b>Undercounter Refrigeration</b>	<b>67</b>
<b>Warranty</b>	<b>75</b>

*Features and specifications indicated herein and on our website are subject to change at any time without notice. Check our website, [subzero.com](http://subzero.com), for the most up-to-date specifications.*

The information and images in this guide are the copyright property of Sub-Zero Freezer Company, Inc. Neither this book nor any information or images contained herein may be copied or used in whole or in part without the express written permission of Sub-Zero Freezer Company, Inc.

©Sub-Zero Freezer Company, Inc. all rights reserved.

## WELCOME TO SUB-ZERO

We make the ultimate built-in, integrated and undercounter refrigerators, freezers and wine storage units. We offer more solutions to your daily design problems of trying to work the largest appliance into a home without being obtrusive. Placing refrigeration in the home is no longer a problem, but, rather, an opportunity to exercise your creativity.

Sub-Zero has rethought traditional built-in refrigeration, a category it pioneered, with over 60 years of experience. When our complete line of configurations—all refrigerator and all freezer, over-and-under, or side-by-side—are coupled with three design alternatives and classic, platinum and carbon stainless steel finishes, the result is unlimited flexibility in satisfying your client's needs for residential refrigeration.

Created to blend invisibly into your home's decor, the Integrated line lets you incorporate refrigeration anywhere in the house—the kitchen, master suite, media room or workout room. These tall units or two-drawer base refrigerators, freezers and combination units can be hidden inside the furniture or cabinetry of your choosing.

Sub-Zero is breaking with conventional ways of offering Wine Storage for designers and their clients. Our Built-In and Integrated models, along with the free-standing Model 424FS, offer unlimited design and storage capabilities.

Our reputation is legendary. We have engineered and manufactured the best products in the business, and we stand behind our products with an unsurpassed warranty and a network of technicians to help you if service is necessary. See details of our warranty at the end of this guide.

Comprehensive installation instructions are shipped with each model. Refer to those instructions in preparing and installing all Sub-Zero products; call Sub-Zero Freezer Company at 800-222-7820, or check our website at [subzero.com](http://subzero.com) to obtain product specifications and illustrations, along with downloadable 2D CAD and pdf files.

## SUB-ZERO WARRANTY

**Sub-Zero products are covered by a two, five and twelve year residential warranty (exclusions apply). See warranty details at the end of this guide.**

As you follow these instructions, you will notice warning and caution symbols. This blocked information is important for the safe and efficient installation of Sub-Zero equipment. There are two types of potential hazards that may occur during installation.

### ⚠ CAUTION

signals a situation where minor injury or product damage may occur if you do not follow instructions.

### ⚠ WARNING

states a hazard that may cause serious injury or death if precautions are not followed.

Another footnote we would like to identify is **IMPORTANT NOTE**: This highlights information that is especially relevant to a problem-free installation.



BUILT-IN

## BUILT-IN REFRIGERATION

Sub-Zero’s Built-In line offers you the most complete set of design options in built-in refrigeration for all of its models, from the classic look of the framed unit to the beauty of the overlay models and the professional treatment of the wrapped stainless steel doors.

Aside from the classic stainless steel, Sub-Zero offers platinum and carbon premium stainless steel finishes on its Built-In models and many related accessories. The only exception to these design alternatives are Models 648PRO and 648PROG, which are offered only in the classic stainless steel design application. In addition, Models 685 and 695 are offered in framed, overlay and classic stainless steel (not platinum or carbon).

Glass doors are available on our Models 601R, 611 and 650. They each come in a framed, overlay and stainless steel design. They all meet stringent Department of Energy standards. Model 648PROG also features a glass door in its classic stainless steel look.

In the illustrations, we have shown the three different design configurations of the framed, overlay and stainless steel units applied to Model 695. Please note how we qualify the different looks with the model number.

The traditional framed units come with an elegant full-length handle and an 11" (279) louvered grille.

Overlay models will come with no handle hardware, because the beauty of this design is that you can match the surrounding cabinetry hardware; however, we do offer optional handles as sales accessories. The new ice and water dispensing Models 685 and 695 are able to accept overlay panels. Overlay models will come with a standard 11" (279) panel grille that will accept decorative panel inserts. Models 601R, 601RG and 601F are only available with the louvered grille. No panel grille option is available.

All stainless steel models, with the exception of those mentioned earlier, are offered in the classic stainless steel finish and in the premium finishes of platinum and carbon. Stainless steel models come with a standard 11" (279) heavy-duty grille, 1" (25) diameter stainless steel handles and a stainless steel kickplate.

All grilles will be offered as options in 1" (25) increments from 10" (254) to 15" (381) and can be ordered as sales accessories. Models 601R, 601RG, 601F, 648PRO and 648PROG are the exception and are available only with an 11" (279) grille.

An important step in assuring a successful plan is to make sure that the actual equipment shipped to your installation site matches the design you have ordered. Each of these three design options—framed, overlay and stainless steel—has specific installation requirements, which means it is vital that the unit match your planning and space needs.

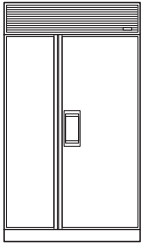

**Model 695/F  
Framed**

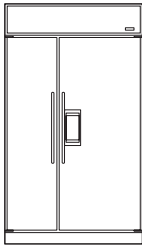

**Model 695/O  
Overlay**

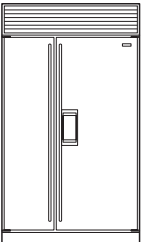

**Model 695/S  
Classic  
Stainless Steel**



BUILT-IN

## BUILT-IN REFRIGERATION

These illustrations represent the full line of Sub-Zero Built-In models shown in the stainless steel design application with heavy-duty grille. Models 648PRO and 648PROG are available as built-in or free-standing units in classic stainless steel only.

For information regarding specific Built-In models, refer to the illustrations in this section. Regardless of the specific design application, framed, overlay or stainless steel, the interior specifications of each model are identical.

## ALL REFRIGERATOR | ALL FREEZER

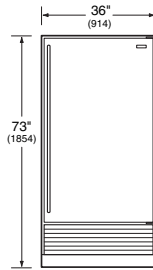

**MODEL 601R**  
All Refrigerator  
Energy Star  
Qualified

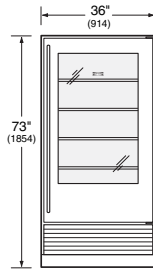

**MODEL 601RG**  
All Refrigerator  
with Glass Door  
Energy Star  
Qualified

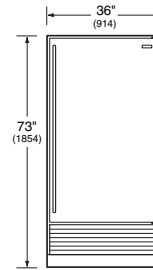

**MODEL 601F**  
All Freezer

## OVER-AND-UNDER

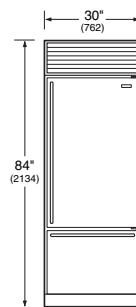

**MODEL 611**  
Energy Star  
Qualified

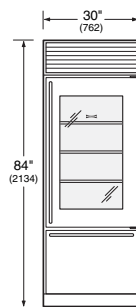

**MODEL 611G**  
with Glass Door

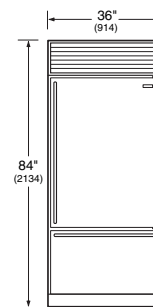

**MODEL 650**  
Energy Star  
Qualified

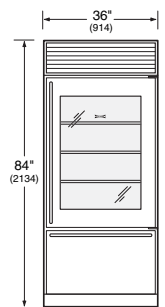

**MODEL 650G**  
with Glass Door



With the installation of a harness kit, these appliances are Star-K compliant to meet strict religious regulations in conjunction with specific instructions found on [www.star-k.org](http://www.star-k.org). Models 648PRO and 648PROG are Star-K certified from the factory with no extra wiring harness required. For details about the harness kit, contact your Sub-Zero dealer.

## SIDE-BY-SIDE

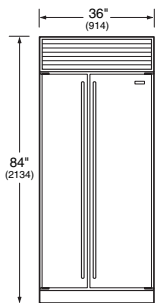

**MODEL 661**

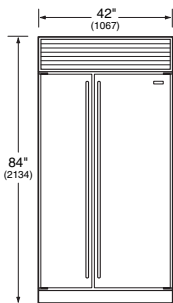

**MODEL 642**

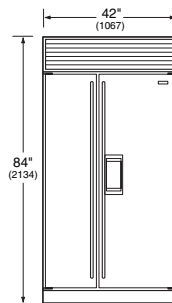

**MODEL 685**  
Ice / Water  
Dispensing

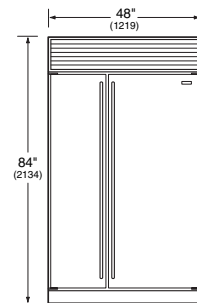

**MODEL 632**

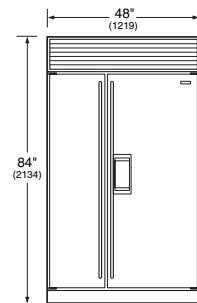

**MODEL 695**  
Ice / Water  
Dispensing

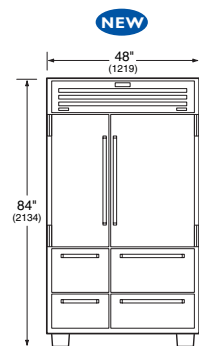

**MODEL 648PRO**  
Free-Standing  
or Built-In  
Available  
Late Fall 2005

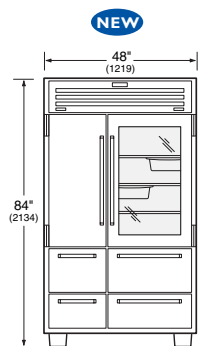

**MODEL 648PROG**  
Free-Standing  
or Built-In  
Available  
Late Fall 2005

Comprehensive installation instructions are shipped with each model. Refer to those instructions in preparing and installing all Sub-Zero products; call Sub-Zero Freezer Company at 800-222-7820 or check our website at [subzero.com](http://subzero.com).

Dimensions in parentheses are in millimeters unless otherwise specified.



BUILT-IN

## BUILT-IN FEATURES

**Framed** models—the classic look that made Sub-Zero famous—feature a louvered grille and elegant full-length handle. An optional panel grille is available for framed units, except for Models 601R, 601RG and 601F. Optional panel conversion kits are available for the new ice and water dispensing Models 685 and 695.

**Overlay** models blend seamlessly into your overall room design and complement surrounding cabinetry. You add decorative hardware. Overlay models come with a panel grille that will accept decorative panel inserts. The new ice and water dispensing Models 685 and 695 are also available in the overlay application.

**Stainless steel** models feature wrapped doors, 1" (25) diameter stainless steel handles and a heavy-duty grille designed specifically to enhance the aesthetics of today's professional looking kitchens. All Built-In stainless steel models are offered in the classic stainless steel finish and in the premium finishes of platinum and carbon, except for Models 685, 695, 648PRO and 648PROG, which are offered in classic stainless steel only. The premium finishes are treated as special orders and must be ordered 90 days before you expect delivery.

**Dual Refrigeration System.** All Built-In combination models have the exclusive Sub-Zero dual refrigeration system, which ensures the freshest food and energy efficiency at the same time. You have precise independent control of the refrigerator and freezer compartments. In addition to two compressors, the PRO 48 has three separate evaporators to keep foods fresher longer and prevent odor transfer.

**Glass Door.** Model 601RG is an all refrigerator unit featuring a glass door. Models 611G and 650G are over-and-under combination units with a glass door on the refrigerator. These glass door models come in framed, overlay and stainless steel designs and meet stringent Department of Energy standards. The side-by-side Model 648PROG features a glass door on the refrigerator side and comes in classic stainless steel only.

**Stainless Steel.** The PRO 48 (Models 648PRO and 648PROG) feature stainless steel construction inside and out with classic finish for professional strength and beauty.

**Ice and Water Dispensing.** Models 685 and 695 feature a dispenser that gives you both ice and chilled water through the refrigerator door.

**Built-In Design.** True cabinet depth design means every inch of the interior is easy to see and to reach. The PRO 48 can be built in or, with the free-standing accessory kit, used in a free-standing application.

**Fresh Food.** High humidity crisper drawer with removable dividers is large and deep, with smooth sides for easy cleaning. The top refrigerated drawer on the PRO 48 features a tight-seal, retracting glass crisper lid that keeps produce exceptionally humid and fresh.

**Electronic Controls.** Up-front touch controls give you digital readings for quick, easy-to-read reference. The microprocessor provides supreme control, accurate to within one degree of preset temperatures, automatic defrosting that senses, then adapts to your use patterns, and a vacuum condenser indicator light. The PRO 48 also features exterior temperature displays.

**Advanced Lighting.** Bright lighting spreads even illumination throughout the compartment. The source of the illumination is concealed. The PRO 48 top LED lights bathe upper compartments in a soft glow. On the refrigerator side, channeled sidewall LEDs can even serve as a door-area night-light for Model 648PROG.

**Adjustable Shelves.** Cantilevered glass shelves make repositioning quick and easy. They are easy to clean, spill proof and steel reinforced for durability. The PRO 48 features glass shelves with stainless steel trim in the refrigerator and 100% stainless steel shelves in the freezer.

**Slide-Out Bins.** An exclusive PRO 48 feature—these versatile stainless steel bins hold small items, remove easily, and fit neatly under any shelf.

**Door Shelves.** All door shelves are adjustable for complete flexibility and convenience.

**Dairy Storage.** Dairy compartment is adjustable, with easy, one-door access, compartment dividers and a clean design. The dairy shelf is magnetically sealed to maintain freshness.

**Automatic Ice.** Ice maker provides high-quality, crescent-shaped ice that won't stick to the side of the glass. The PRO 48 features a water filter located just behind the easy-access pop-up grille, for ice as pure as it is fresh.

**Energy Efficient.** Our solid core doors improve insulation and structural integrity and help us exceed tough Department of Energy standards. Magnetic gaskets around all doors give extra-tight seals.

**Kickplate.** Solid, adjustable kickplate gives a true built-in look and conforms to American Institute of Architects standards.

## SUB-ZERO WARRANTY

Sub-Zero products are covered by a two, five and twelve year residential warranty (exclusions apply). See warranty details at the end of this guide.

## ACCESSORIES

Optional accessories are available through your Sub-Zero dealer, or call Sub-Zero at 800-222-7820. You can also visit our website at [subzero.com](http://subzero.com) and click on the accessories section for your specific model.

*Dimensions in parentheses are in millimeters unless otherwise specified.*



BUILT-IN

### MODEL 601R

ALL REFRIGERATOR

*Energy Star Qualified*

#### MODEL OPTIONS

Framed Design	<b>601R/F</b>
Overlay Design	<b>601R/O</b>
Classic Stainless Steel	<b>601R/S</b>
Platinum Stainless Steel	<b>601R/P</b>
Carbon Stainless Steel	<b>601R/B</b>

#### SPECIFICATIONS

Overall Width	<b>36" (914)</b>
Overall Height	<b>73" (1854)</b>
Overall Depth	<b>24" (610)</b>
Refrigerator Capacity	<b>19.9 cu ft (564 L)</b>
Min Height Required	<b>72<sup>3</sup>/<sub>4</sub>" (1848)</b>
Door Swing Clearance	<b>36<sup>1</sup>/<sub>16</sub>" (916)</b>
Specify Door Swing	<b>LH or RH</b>
Annual Energy Usage	<b>399 kWh   \$34*</b>
Shipping Wt (F)	<b>391 lbs (177 kg)</b>
Shipping Wt (O)	<b>391 lbs (177 kg)</b>
Shipping Wt (S/P/B)	<b>420 lbs (191 kg)</b>

#### REFRIGERATOR FEATURES

- 4 Adjustable Glass Shelves
- 1 Stationary Glass Shelf
- High Humidity Compartment with Dividers
- Adjustable Roll-Out Deli Basket
- 3 Adjustable Door Shelves
- Adjustable Dairy Compartment
- Egg Container

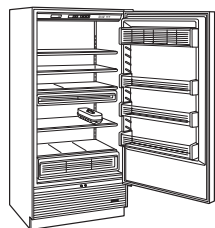

MODEL 601R

### MODEL 601RG

ALL REFRIGERATOR WITH GLASS DOOR

*Energy Star Qualified*

#### MODEL OPTIONS

Framed Design	<b>601RG/F</b>
Overlay Design	<b>601RG/O</b>
Classic Stainless Steel	<b>601RG/S</b>
Platinum Stainless Steel	<b>601RG/P</b>
Carbon Stainless Steel	<b>601RG/B</b>

#### SPECIFICATIONS

Overall Width	<b>36" (914)</b>
Overall Height	<b>73" (1854)</b>
Overall Depth	<b>24" (610)</b>
Refrigerator Capacity	<b>20.1 cu ft (569 L)</b>
Min Height Required	<b>72<sup>3</sup>/<sub>4</sub>" (1848)</b>
Door Swing Clearance	<b>36<sup>1</sup>/<sub>16</sub>" (916)</b>
Specify Door Swing	<b>LH or RH</b>
Annual Energy Usage	<b>400 kWh   \$34*</b>
Shipping Wt (F)	<b>400 lbs (181 kg)</b>
Shipping Wt (O)	<b>400 lbs (181 kg)</b>
Shipping Wt (S/P/B)	<b>430 lbs (195 kg)</b>

#### REFRIGERATOR FEATURES

- 4 Adjustable Glass Shelves
- 1 Stationary Glass Shelf
- High Humidity Compartment with Dividers
- Triple-Pane UV Resistant Glass Door
- Optional Accessory Roll-Out Deli Basket Available
- Egg Container
- Optional High Altitude Glass Available\*\*



MODEL 601RG

### MODEL 601F

ALL FREEZER

#### MODEL OPTIONS

Framed Design	<b>601F/F</b>
Overlay Design	<b>601F/O</b>
Classic Stainless Steel	<b>601F/S</b>
Platinum Stainless Steel	<b>601F/P</b>
Carbon Stainless Steel	<b>601F/B</b>

#### SPECIFICATIONS

Overall Width	<b>36" (914)</b>
Overall Height	<b>73" (1854)</b>
Overall Depth	<b>24" (610)</b>
Freezer Capacity	<b>19.3 cu ft (547 L)</b>
Min Height Required	<b>72<sup>3</sup>/<sub>4</sub>" (1848)</b>
Door Swing Clearance	<b>36<sup>1</sup>/<sub>16</sub>" (916)</b>
Specify Door Swing	<b>LH or RH</b>
Annual Energy Usage	<b>737 kWh   \$62*</b>
Shipping Wt (F)	<b>378 lbs (171 kg)</b>
Shipping Wt (O)	<b>378 lbs (171 kg)</b>
Shipping Wt (S/P/B)	<b>406 lbs (184 kg)</b>

#### FREEZER FEATURES

- Automatic Ice Maker
- 3 Adjustable Wire Shelves
- 1 Stationary Glass Shelf
- 3 Freezer Storage Drawers
- 5 Adjustable Door Shelves

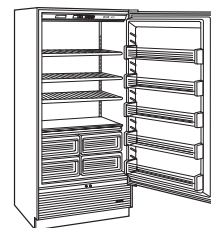

MODEL 601F

*\*Annual energy costs are based on 8.29 cents per kilowatt hour.*

*\*\*High altitude glass doors are for installations at or above 5,000' (1524 m) in elevation and will be treated as a special order. Please allow 90 days for delivery. When ordering, add an (HA) before the (G) to obtain the correct model number.*

*All models are shown in the framed design application.*

#### ACCESSORIES

Contact your Sub-Zero Dealer

Front panels for framed design in white, almond and classic stainless steel

Side panels for framed or stainless steel design in white, almond and classic stainless steel

Extended framed handles  
Decorative overlay handles

90° and 105° door stop kits

Roll-out deli basket (Model 601RG)

Dozen egg container with lid



BUILT-IN

### MODEL 611

OVER-AND-UNDER

*Energy Star Qualified*

#### MODEL OPTIONS

Framed Design	<b>611/F</b>
Overlay Design	<b>611/O</b>
Classic Stainless Steel	<b>611/S</b>
Platinum Stainless Steel	<b>611/P</b>
Carbon Stainless Steel	<b>611/B</b>

#### SPECIFICATIONS

Overall Width	<b>30" (762)</b>
Overall Height	<b>84" (2134)</b>
Overall Depth	<b>24" (610)</b>
Refrigerator Capacity	<b>12.7 cu ft (360 L)</b>
Freezer Capacity	<b>3.9 cu ft (110 L)</b>
Min Height Required	<b>83" (2108)</b>
Door Swing Clearance	<b>30 1/8" (765)</b>
Annual Energy Usage	<b>463 kWh   \$39*</b>
Shipping Wt (F)	<b>430 lbs (195 kg)</b>
Shipping Wt (O)	<b>430 lbs (195 kg)</b>
Shipping Wt (S/P/B)	<b>462 lbs (210 kg)</b>

#### REFRIGERATOR (DOOR)

- 3 Adjustable Glass Shelves
- 1 Stationary Glass Shelf
- High Humidity Compartment with Divider
- Adjustable Roll-Out Deli Basket
- 2 Adjustable Door Shelves
- Adjustable Dairy Compartment
- Egg Container

#### FREEZER (DRAWER)

- Automatic Ice Maker
- Two-Tier Pull Out Drawer

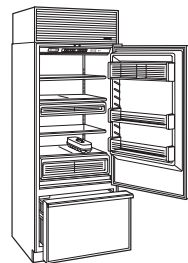

MODEL 611

### MODEL 611G

OVER-AND-UNDER  
WITH GLASS DOOR

#### MODEL OPTIONS

Framed Design	<b>611G/F</b>
Overlay Design	<b>611G/O</b>
Classic Stainless Steel	<b>611G/S</b>
Platinum Stainless Steel	<b>611G/P</b>
Carbon Stainless Steel	<b>611G/B</b>

#### SPECIFICATIONS

Overall Width	<b>30" (762)</b>
Overall Height	<b>84" (2134)</b>
Overall Depth	<b>24" (610)</b>
Refrigerator Capacity	<b>12.9 cu ft (365 L)</b>
Freezer Capacity	<b>3.9 cu ft (110 L)</b>
Min Height Required	<b>83" (2108)</b>
Door Swing Clearance	<b>30 1/8" (765)</b>
Annual Energy Usage	<b>544 kWh   \$46*</b>
Shipping Wt (F)	<b>471 lbs (214 kg)</b>
Shipping Wt (O)	<b>471 lbs (214 kg)</b>
Shipping Wt (S/P/B)	<b>476 lbs (216 kg)</b>

#### REFRIGERATOR (DOOR)

- 3 Adjustable Glass Shelves
- 1 Stationary Glass Shelf
- High Humidity Compartment with Divider
- Triple-Pane UV Resistant Glass Door
- Optional Accessory Roll-Out Deli Basket Available
- Egg Container
- Optional High Altitude Glass Available\*\*

#### FREEZER (DRAWER)

- Automatic Ice Maker
- Two-Tier Pull Out Drawer

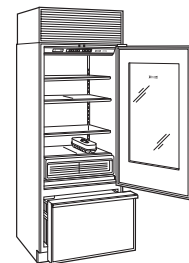

MODEL 611G

*\*Annual energy costs are based on 8.29 cents per kilowatt hour.*

*\*\*High altitude glass doors are for installations at or above 5,000' (1524 m) in elevation and will be treated as a special order. Please allow 90 days for delivery. When ordering, add an (HA) before the (G) to obtain the correct model number.*

*All models are shown in the framed design application.*



BUILT-IN

### MODEL 650

OVER-AND-UNDER

*Energy Star Qualified*

#### MODEL OPTIONS

Framed Design	<b>650/F</b>
Overlay Design	<b>650/O</b>
Classic Stainless Steel	<b>650/S</b>
Platinum Stainless Steel	<b>650/P</b>
Carbon Stainless Steel	<b>650/B</b>

#### SPECIFICATIONS

Overall Width	<b>36" (914)</b>
Overall Height	<b>84" (2134)</b>
Overall Depth	<b>24" (610)</b>
Refrigerator Capacity	<b>15.7 cu ft (445 L)</b>
Freezer Capacity	<b>4.9 cu ft (139 L)</b>
Min Height Required	<b>83" (2108)</b>
Door Swing Clearance	<b>36<sup>1</sup>/<sub>16</sub>" (916)</b>
Annual Energy Usage	<b>481 kWh   \$40*</b>
Shipping Wt (F)	<b>482 lbs (219 kg)</b>
Shipping Wt (O)	<b>482 lbs (219 kg)</b>
Shipping Wt (S/P/B)	<b>515 lbs (234 kg)</b>

#### REFRIGERATOR (DOOR)

- 3 Adjustable Glass Shelves
- 1 Stationary Glass Shelf
- High Humidity Compartment with Dividers
- Adjustable Roll-Out Deli Basket
- 2 Adjustable Door Shelves
- Adjustable Dairy Compartment
- Egg Container

#### FREEZER (DRAWER)

- Automatic Ice Maker
- Two-Tier Pull Out Drawer

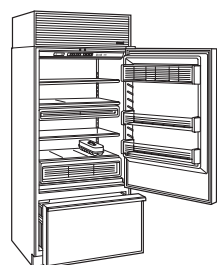

MODEL 650

### MODEL 650G

OVER-AND-UNDER  
WITH GLASS DOOR

#### MODEL OPTIONS

Framed Design	<b>650G/F</b>
Overlay Design	<b>650G/O</b>
Classic Stainless Steel	<b>650G/S</b>
Platinum Stainless Steel	<b>650G/P</b>
Carbon Stainless Steel	<b>650G/B</b>

#### SPECIFICATIONS

Overall Width	<b>36" (914)</b>
Overall Height	<b>84" (2134)</b>
Overall Depth	<b>24" (610)</b>
Refrigerator Capacity	<b>16.0 cu ft (453 L)</b>
Freezer Capacity	<b>4.9 cu ft (139 L)</b>
Min Height Required	<b>83" (2108)</b>
Door Swing Clearance	<b>36<sup>1</sup>/<sub>16</sub>" (916)</b>
Annual Energy Usage	<b>565 kWh   \$47*</b>
Shipping Wt (F)	<b>523 lbs (237 kg)</b>
Shipping Wt (O)	<b>523 lbs (237 kg)</b>
Shipping Wt (S/P/B)	<b>529 lbs (240 kg)</b>

#### REFRIGERATOR (DOOR)

- 3 Adjustable Glass Shelves
- 1 Stationary Glass Shelf
- High Humidity Compartment with Dividers
- Triple-Pane UV Resistant Glass Door
- Optional Accessory Roll-Out Deli Basket Available
- Egg Container
- Optional High Altitude Glass Available\*\*

#### FREEZER (DRAWER)

- Automatic Ice Maker
- Two-Tier Pull Out Drawer

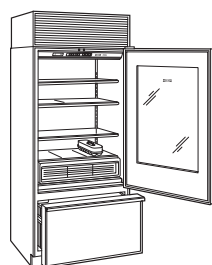

MODEL 650G

#### ACCESSORIES

Optional accessories are available through your Sub-Zero dealer, or call Sub-Zero at 800-222-7820. You can also visit our website at [subzero.com](http://subzero.com) and click on the accessories section for your specific model.

#### ACCESSORIES

Contact your Sub-Zero Dealer

Front and grille panels for framed design in white, almond and classic stainless steel

Side panels for framed or stainless steel design in white, almond and classic stainless steel

Louvered, panel or stainless steel grilles in 1" (25) increments from 10" (254) to 15" (381) high

Extended framed handles

Decorative overlay handles

Roll-out deli basket (Models 611G and 650G)

Dozen egg container with lid

*Dimensions in parentheses are in millimeters unless otherwise specified.*



## MODEL 661

SIDE-BY-SIDE

### MODEL OPTIONS

Framed Design	<b>661/F</b>
Overlay Design	<b>661/O</b>
Classic Stainless Steel	<b>661/S</b>
Platinum Stainless Steel	<b>661/P</b>
Carbon Stainless Steel	<b>661/B</b>

### SPECIFICATIONS

Overall Width	<b>36" (914)</b>
Overall Height	<b>84" (2134)</b>
Overall Depth	<b>24" (610)</b>
Refrigerator Capacity	<b>12.5 cu ft (354 L)</b>
Freezer Capacity	<b>8.8 cu ft (249 L)</b>
Min Height Required	<b>83" (2108)</b>
Door Swing Clearance	<b>20<sup>3</sup>/<sub>4</sub>" (527)</b>
Annual Energy Usage	<b>636 kWh   \$53*</b>
Shipping Wt (F)	<b>500 lbs (227 kg)</b>
Shipping Wt (O)	<b>500 lbs (227 kg)</b>
Shipping Wt (S/P/B)	<b>538 lbs (244 kg)</b>

### REFRIGERATOR FEATURES

- 4 Adjustable Glass Shelves
- 1 Stationary Glass Shelf
- High Humidity Compartment
- 1 Storage Drawer
- Adjustable Roll-Out Deli Basket
- 3 Adjustable Door Shelves
- Adjustable Dairy Compartment
- Egg Container

### FREEZER FEATURES

- Automatic Ice Maker
- 2 Adjustable Wire Shelves
- 1 Stationary Solid Shelf
- 4 Storage Drawers
- 5 Adjustable Door Shelves

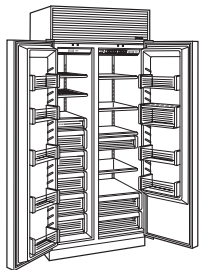

MODEL 661

## MODEL 642

SIDE-BY-SIDE

### MODEL OPTIONS

Framed Design	<b>642/F</b>
Overlay Design	<b>642/O</b>
Classic Stainless Steel	<b>642/S</b>
Platinum Stainless Steel	<b>642/P</b>
Carbon Stainless Steel	<b>642/B</b>

### SPECIFICATIONS

Overall Width	<b>42" (1067)</b>
Overall Height	<b>84" (2134)</b>
Overall Depth	<b>24" (610)</b>
Refrigerator Capacity	<b>16.2 cu ft (459 L)</b>
Freezer Capacity	<b>8.2 cu ft (232 L)</b>
Min Height Required	<b>83" (2108)</b>
Door Swing Clearance	<b>25<sup>9</sup>/<sub>16</sub>" (649)</b>
Annual Energy Usage	<b>650 kWh   \$54*</b>
Shipping Wt (F)	<b>541 lbs (245 kg)</b>
Shipping Wt (O)	<b>541 lbs (245 kg)</b>
Shipping Wt (S/P/B)	<b>582 lbs (264 kg)</b>

### REFRIGERATOR FEATURES

- 4 Adjustable Glass Shelves
- 1 Stationary Glass Shelf
- High Humidity Compartment
- 1 Storage Drawer
- Adjustable Roll-Out Deli Basket
- 3 Adjustable Door Shelves
- Adjustable Dairy Compartment
- Egg Container

### FREEZER FEATURES

- Automatic Ice Maker
- 3 Adjustable Wire Shelves
- 1 Stationary Solid Shelf
- 3 Storage Drawers
- 5 Adjustable Door Shelves

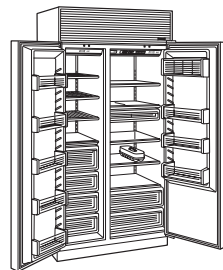

MODEL 642

## MODEL 685

SIDE-BY-SIDE  
ICE | WATER DISPENSING

### MODEL OPTIONS

Framed Design	<b>685/F</b>
Overlay Design	<b>685/O</b>
Classic Stainless Steel	<b>685/S</b>

### SPECIFICATIONS

Overall Width	<b>42" (1067)</b>
Overall Height	<b>84" (2134)</b>
Overall Depth	<b>24" (610)</b>
Refrigerator Capacity	<b>15.6 cu ft (442 L)</b>
Freezer Capacity	<b>8.2 cu ft (232 L)</b>
Min Height Required	<b>83" (2108)</b>
Door Swing Clearance	<b>25<sup>9</sup>/<sub>16</sub>" (649)</b>
Annual Energy Usage	<b>694 kWh   \$58*</b>
Shipping Wt (F)	<b>569 lbs (258 kg)</b>
Shipping Wt (O)	<b>569 lbs (258 kg)</b>
Shipping Wt (S)	<b>608 lbs (276 kg)</b>

### REFRIGERATOR FEATURES

- 4 Adjustable Glass Shelves
- 1 Stationary Glass Shelf
- High Humidity Compartment
- 1 Storage Drawer
- Adjustable Roll-Out Deli Basket
- 3 Adjustable Door Shelves
- Adjustable Dairy Compartment
- Egg Container

### FREEZER FEATURES

- Automatic Ice Maker
- 2 Adjustable Wire Shelves
- 1 Stationary Wire Shelf
- 3 Storage Drawers
- 5 Adjustable Door Shelves
- 2 Juice Can Shelves

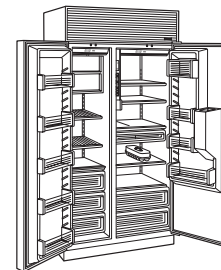

MODEL 685



BUILT-IN

## MODEL 632

SIDE-BY-SIDE

### MODEL OPTIONS

Framed Design	<b>632/F</b>
Overlay Design	<b>632/O</b>
Classic Stainless Steel	<b>632/S</b>
Platinum Stainless Steel	<b>632/P</b>
Carbon Stainless Steel	<b>632/B</b>

### SPECIFICATIONS

Overall Width	<b>48" (1219)</b>
Overall Height	<b>84" (2134)</b>
Overall Depth	<b>24" (610)</b>
Refrigerator Capacity	<b>18.9 cu ft (535 L)</b>
Freezer Capacity	<b>9.8 cu ft (278 L)</b>
Min Height Required	<b>83" (2108)</b>
Door Swing Clearance	<b>29<sup>1</sup>/<sub>4</sub>" (743)</b>
Annual Energy Usage	<b>675 kWh   \$56*</b>
Shipping Wt (F)	<b>582 lbs (264 kg)</b>
Shipping Wt (O)	<b>582 lbs (264 kg)</b>
Shipping Wt (S/P/B)	<b>630 lbs (286 kg)</b>

### REFRIGERATOR FEATURES

- 4 Adjustable Glass Shelves
- 1 Stationary Glass Shelf
- High Humidity Compartment with Divider
- 2 Storage Drawers
- Adjustable Roll-Out Deli Basket
- 3 Adjustable Door Shelves
- Adjustable Dairy Compartment
- Egg Container

### FREEZER FEATURES

- Automatic Ice Maker
- 3 Adjustable Wire Shelves
- 1 Stationary Solid Shelf
- 3 Storage Drawers
- 5 Adjustable Door Shelves

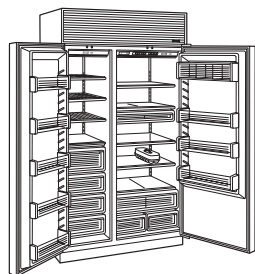

MODEL 632

## MODEL 695

SIDE-BY-SIDE  
ICE | WATER DISPENSING

### MODEL OPTIONS

Framed Design	<b>695/F</b>
Overlay Design	<b>695/O</b>
Classic Stainless Steel	<b>695/S</b>

### SPECIFICATIONS

Overall Width	<b>48" (1219)</b>
Overall Height	<b>84" (2134)</b>
Overall Depth	<b>24" (610)</b>
Refrigerator Capacity	<b>18.2 cu ft (515 L)</b>
Freezer Capacity	<b>9.8 cu ft (278 L)</b>
Min Height Required	<b>83" (2108)</b>
Door Swing Clearance	<b>29<sup>1</sup>/<sub>4</sub>" (743)</b>
Annual Energy Usage	<b>747 kWh   \$62*</b>
Shipping Wt (F)	<b>610 lbs (277 kg)</b>
Shipping Wt (O)	<b>610 lbs (277 kg)</b>
Shipping Wt (S)	<b>656 lbs (298 kg)</b>

### REFRIGERATOR FEATURES

- 4 Adjustable Glass Shelves
- 1 Stationary Glass Shelf
- High Humidity Compartment with Divider
- 2 Storage Drawers
- Adjustable Roll-Out Deli Basket
- 3 Adjustable Door Shelves
- Adjustable Dairy Compartment
- Egg Container

### FREEZER FEATURES

- Automatic Ice Maker
- 2 Adjustable Wire Shelves
- 1 Stationary Wire Shelf
- 3 Storage Drawers
- 5 Adjustable Door Shelves
- 2 Juice Can Shelves

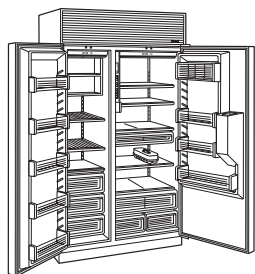

MODEL 695

*\*Annual energy costs are based on 8.29 cents per kilowatt hour.*

*All models are shown in the framed design application.*

### ACCESSORIES

Contact your Sub-Zero Dealer

Front and grille panels for framed design in white, almond and classic stainless steel

Side panels for framed or stainless steel design in white, almond and classic stainless steel

Louvered, panel or stainless steel grilles in 1" (25) increments from 10" (254) to 15" (381) high

Framed panel kits (Models 685 and 695)\*

Extended framed handles

Decorative overlay handles

90° and 105° door stop kits

Dozen egg container with lid

*\*See page 19 for additional information.*

*Dimensions in parentheses are in millimeters unless otherwise specified.*



BUILT-IN

### MODEL 648PRO

**NEW** Available Late Fall 2005

SIDE-BY-SIDE  
BUILT-IN OR FREE-STANDING

#### SPECIFICATIONS

Overall Width	<b>48" (1219)</b>
Overall Height	<b>84" (2134)</b>
Overall Depth	<b>25<sup>7</sup>/<sub>8</sub>" (657)</b>
Refrigerator Capacity	<b>18.4 cu ft (521 L)</b>
Freezer Capacity	<b>11.4 cu ft (323 L)</b>
Min Height Required	<b>83<sup>1</sup>/<sub>2</sub>" (2121)</b>
Door Swing Clearance	<b>28<sup>3</sup>/<sub>4</sub>" (730)</b>
Annual Energy Usage	<b>689 kWh   \$58*</b>
Shipping Weight	<b>860 lbs (390 kg)</b>

#### REFRIGERATOR

*(Door and Two Drawers)*

- 3 Adjustable Glass Shelves
- 1 Stationary Glass Shelf
- 2 Adjustable Slide-Out Stainless Steel Bins
- 1 Crisper Lid
- Dividers for Drawers Included

#### FREEZER

*(Door and Two Drawers)*

- Automatic Ice Maker
- Water Filtration Filter
- 3 Adjustable Stainless Steel Shelves
- 1 Stationary Stainless Steel Shelf
- 1 Stainless Steel Ice Bucket



MODEL 648PRO

### MODEL 648PROG

**NEW** Available Late Fall 2005

SIDE-BY-SIDE  
WITH GLASS DOOR  
BUILT-IN OR FREE-STANDING

#### SPECIFICATIONS

Overall Width	<b>48" (1219)</b>
Overall Height	<b>84" (2134)</b>
Overall Depth	<b>25<sup>7</sup>/<sub>8</sub>" (657)</b>
Refrigerator Capacity	<b>18.4 cu ft (521 L)</b>
Freezer Capacity	<b>11.4 cu ft (323 L)</b>
Min Height Required	<b>83<sup>1</sup>/<sub>2</sub>" (2121)</b>
Door Swing Clearance	<b>28<sup>3</sup>/<sub>4</sub>" (730)</b>
Annual Energy Usage	<b>689 kWh   \$58*</b>
Shipping Weight	<b>875 lbs (397 kg)</b>

#### REFRIGERATOR

*(Door and Two Drawers)*

- 3 Adjustable Glass Shelves
- 1 Stationary Glass Shelf
- 2 Adjustable Slide-Out Stainless Steel Bins
- 1 Crisper Lid
- Dividers for Drawers Included
- Triple-Pane UV Resistant Glass Door
- Optional High Altitude Glass Available\*\*

#### FREEZER

*(Door and Two Drawers)*

- Automatic Ice Maker
- Water Filtration Filter
- 3 Adjustable Stainless Steel Shelves
- 1 Stationary Stainless Steel Shelf
- 1 Stainless Steel Ice Bucket

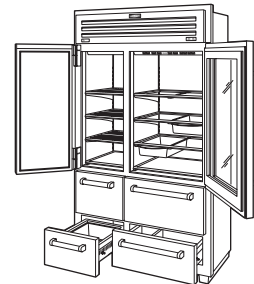

MODEL 648PROG

#### ACCESSORIES

Contact your Sub-Zero Dealer

90° door stop kit—right or left hinge

Dozen egg container with lid

Slide-out stainless steel refrigerator bin

Classic stainless steel side panel

Free-standing kit—includes two stainless steel side panels and top lid



BUILT-IN

## PLANNING INFORMATION

Although the Sub-Zero Built-In line offers a wide range of designs and configurations, the basic planning considerations for all models have much in common. As you integrate Built-In models into your overall plan, review installation requirements for your particular model(s). The Installation Specifications illustrations provide planning information for all Built-In models—framed, overlay and stainless steel.

Allow the door(s) to open a minimum of 90° or you'll have problems removing drawers. With the door opening at 90°, you may have to move drawers slightly to clear the door interior.

For corner installations, allow for a minimum 3" (76) filler so that the door can open to 90°. If you're using raised panels, consider using a wider filler.

When units are installed side by side, a filler strip is recommended. The width of this filler strip will vary depending on the configuration and panels you use.

Be sure to add the filler strip width to your finished rough opening dimension. In any installation of two units side by side without a filler strip, add an additional 1/2" (13) to your combined numbers. This will allow for the proper width.

**IMPORTANT NOTE:** Refer to the full-scale illustrations at the end of this section for specifics on door openings and filler size alternatives.

## ELECTRICAL REQUIREMENTS

A 115 V AC, 60 Hz, 15 amp circuit breaker and electrical supply are required. A separate circuit, servicing only this appliance, is required.

All Sub-Zero Built-In models are equipped with a power supply cord with a 3-prong grounding plug, which must be plugged into a mating 3-prong grounding-type wall receptacle. Follow the National Electrical Code and local codes and ordinances when installing the receptacle. Refer to the Installation Specifications illustration for your model on the following pages.

**IMPORTANT NOTE:** A ground fault circuit interrupter (GFCI) is not recommended and may cause interruption of operation.

## PLUMBING CONSIDERATIONS

For Built-In models with an automatic ice maker, rough in the water supply line. Connect a 1/4" OD copper line to the house supply, being sure to use an easily accessible shut-off valve between the supply and the refrigerator.

Do not use self-piercing valves. A saddle valve kit (4200880) is available from your Sub-Zero dealer.

For Built-In models except Model 648PRO and 648PROG, a line filter is required when water conditions have a high sediment content. The ice maker operates on water pressure of 20 psi (1.4 bar) to 100 psi (6.9 bar).

**IMPORTANT NOTE:** In some cases a reverse osmosis water filter system may not be able to maintain the minimum water pressure consistently.

Models 648PRO and 648PROG come with an automatic ice maker and an integrated water filtration system. This system operates on water pressure between 35 psi (2.4 bar) and 120 psi (8.3 bar).

**IMPORTANT NOTE:** A reverse osmosis system can be used with Models 648PRO and 648PROG, provided there is constant water pressure of 20 psi (1.4 bar) to 120 psi (8.3 bar) supplied to the unit at all times. In this application, the integrated water filtration system must be set to bypass mode. This is achieved by removing the water filter cartridge. Refer to the PRO 48 Installation Guide packed with the unit for detailed instructions.

The water line should be routed up through the floor within 1/2" (13) from the back wall and no higher than 3" (76) off the floor. If you have to come through the wall, make sure the water line is no more than 3" (76) from the floor.

Regardless of the routing, allow 3' (1 m) of excess copper tubing to remain outside the wall or floor for easy connection to the unit. Refer to Installation Specification illustrations.

## MODEL OPTIONS

**Model 601R**  
36" (914)  
*All Refrigerator*

**Model 601RG**  
36" (914)  
*All Refrigerator with Glass Door*

**Model 601F**  
36" (914)  
*All Freezer*

**Model 611**  
30" (762)  
*Over-and-Under*

**Model 611G**  
30" (762)  
*Over-and-Under with Glass Door*

**Model 650**  
36" (914)  
*Over-and-Under*

**Model 650G**  
36" (914)  
*Over-and-Under with Glass Door*

**Model 661**  
36" (914)  
*Side-by-Side*

**Model 642**  
42" (1067)  
*Side-by-Side*

**Model 685**  
42" (1067)  
*Side-by-Side Ice | Water Dispensing*

**Model 632**  
48" (1219)  
*Side-by-Side*

**Model 695**  
48" (1219)  
*Side-by-Side Ice | Water Dispensing*

**Model 648PRO**  
48" (1219)  
*Side-by-Side Built-In or Free-Standing*

**Model 648PROG**  
48" (1219)  
*Side-by-Side with Glass Door Built-In or Free-Standing*



BUILT-IN

OVERALL DIMENSIONS

All Refrigerator | All Freezer Models

ALL REFRIGERATOR  
ALL FREEZER

**Model 601R**  
All Refrigerator

**Model 601RG**  
All Refrigerator  
with Glass Door

**Model 601F**  
All Freezer

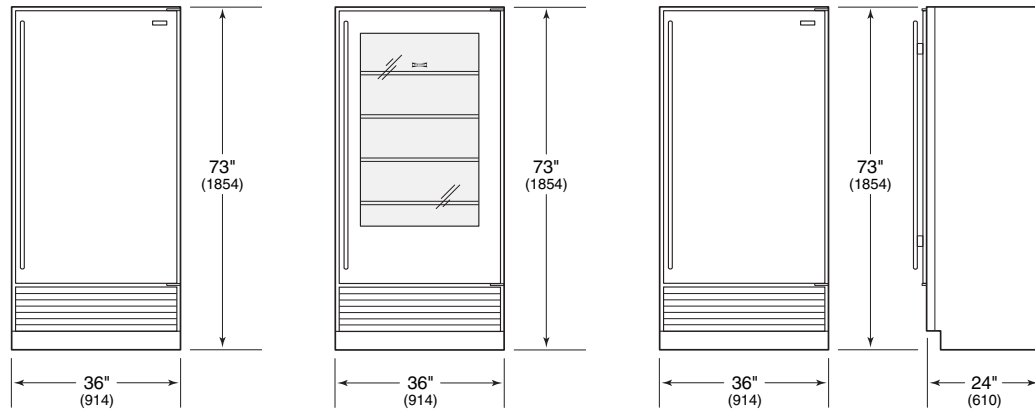

**Model 601R**  
All Refrigerator

Width **36" (914)**  
Height **73" (1854)**  
Depth **24" (610)**

**Model 601RG**  
All Refrigerator  
with Glass Door

Width **36" (914)**  
Height **73" (1854)**  
Depth **24" (610)**

**Model 601F**  
All Freezer

Width **36" (914)**  
Height **73" (1854)**  
Depth **24" (610)**

Illustrations shown in stainless steel design.

INSTALLATION

Refer to the installation instructions shipped with each Sub-Zero product for detailed specifications.

Refer to the full-scale illustrations at the end of this section for specifics on door openings and other specifications.

INSTALLATION SPECIFICATIONS  
All Refrigerator | All Freezer Models

Models 601R and 601RG, which do not have an ice maker, will not require the water line connection.

Dimensions are for finished rough openings.

Door swing clearances are based on stainless steel door and handle dimensions.

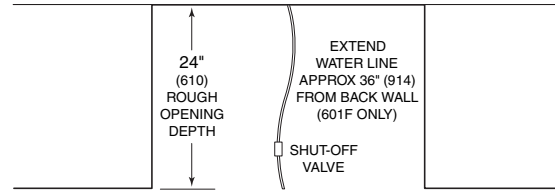
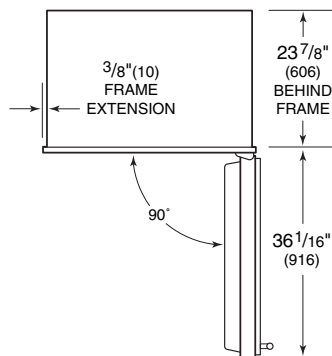

TOP VIEW

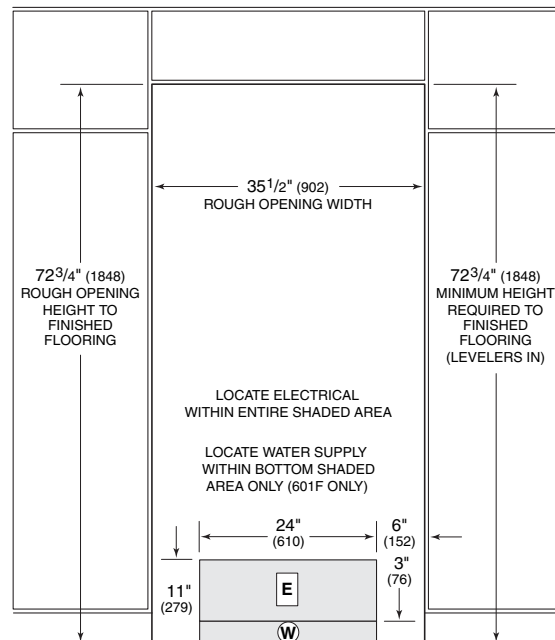

FRONT VIEW



BUILT-IN

OVERALL DIMENSIONS

Over-and-Under Refrigerator/Freezer Models

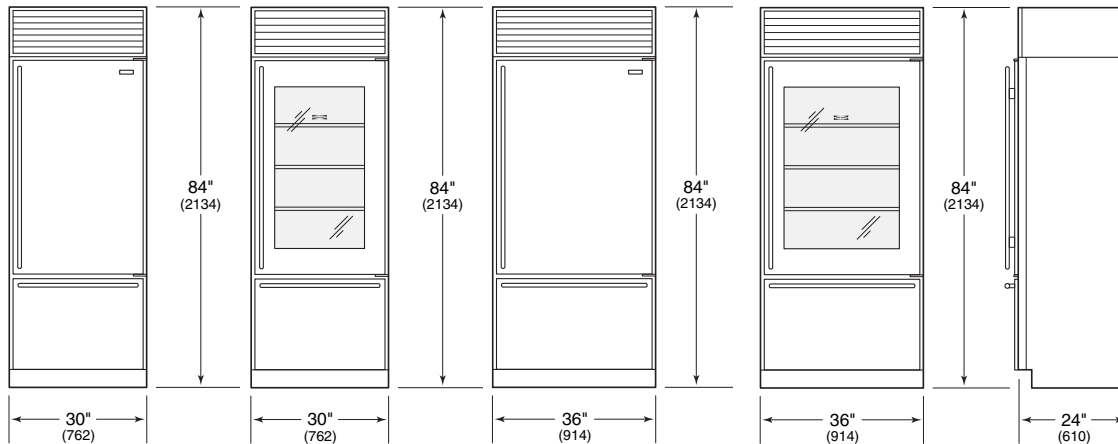

OVER-AND-UNDER

- Model 611**
- Model 611G**  
with Glass Door
- Model 650**
- Model 650G**  
with Glass Door

**Model 611**

Width **30" (762)**  
Height **84" (2134)**  
Depth **24" (610)**

**Model 611G**  
with Glass Door

Width **30" (762)**  
Height **84" (2134)**  
Depth **24" (610)**

**Model 650**

Width **36" (914)**  
Height **84" (2134)**  
Depth **24" (610)**

**Model 650G**  
with Glass Door

Width **36" (914)**  
Height **84" (2134)**  
Depth **24" (610)**

Illustrations shown in stainless steel design.

INSTALLATION SPECIFICATIONS

Over-and-Under Refrigerator/Freezer Models

**Model 611**

**A) Rough Opening Width 29 1/2" (749)**  
**B) Min Door Clearance 30 1/8" (765)**

**Model 611G**

**A) Rough Opening Width 29 1/2" (749)**  
**B) Min Door Clearance 30 1/8" (765)**

**Model 650**

**A) Rough Opening Width 35 1/2" (902)**  
**B) Min Door Clearance 36 1/16" (916)**

**Model 650G**

**A) Rough Opening Width 35 1/2" (902)**  
**B) Min Door Clearance 36 1/16" (916)**

Dimensions are for finished rough openings.

Door swing clearances are based on stainless steel door and handle dimensions.

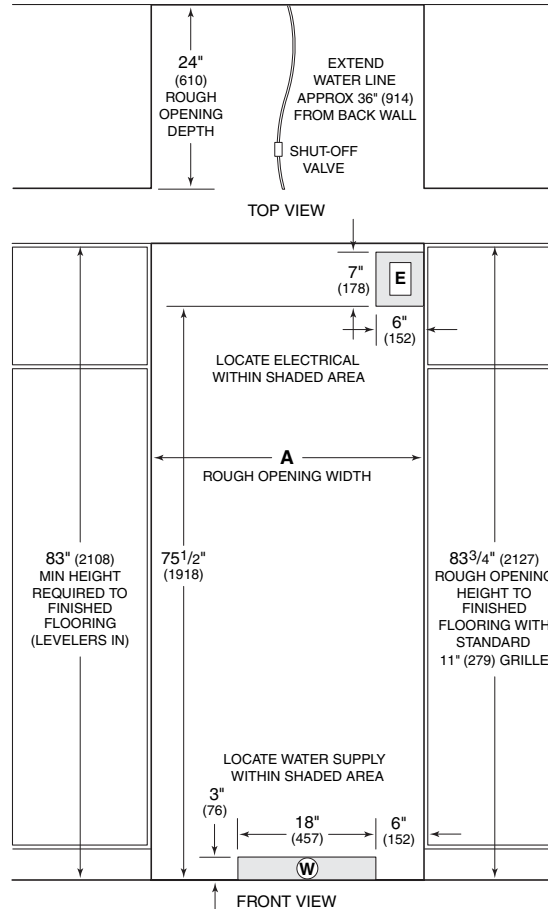

INSTALLATION

Refer to the installation instructions shipped with each Sub-Zero product for detailed specifications.

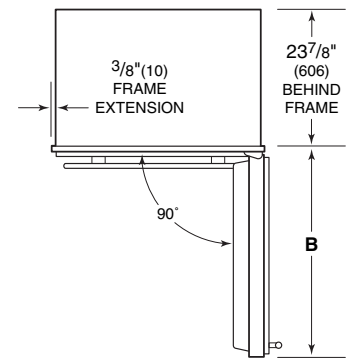

Refer to the full-scale illustrations at the end of this section for specifics on door openings and other specifications.

Dimensions in parentheses are in millimeters unless otherwise specified.



OVERALL DIMENSIONS

Side-by-Side Refrigerator / Freezer Models

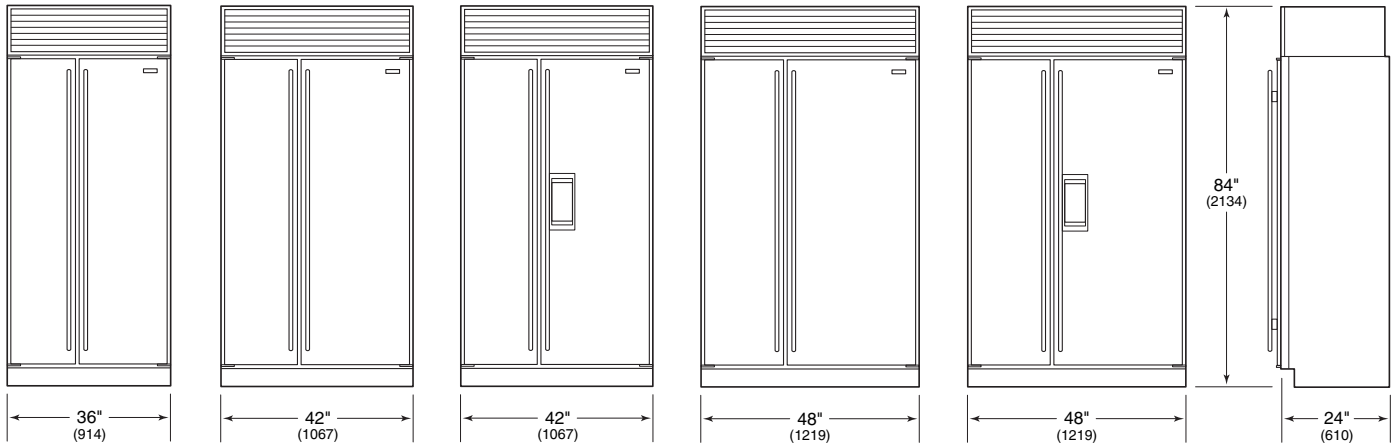

**Model 661**

Width **36" (914)**  
Height **84" (2134)**  
Depth **24" (610)**

**Model 642**

Width **42" (1067)**  
Height **84" (2134)**  
Depth **24" (610)**

**Model 685**

*Ice / Water Dispensing*

Width **42" (1067)**  
Height **84" (2134)**  
Depth **24" (610)**

**Model 632**

Width **48" (1219)**  
Height **84" (2134)**  
Depth **24" (610)**

**Model 695**

*Ice / Water Dispensing*

Width **48" (1219)**  
Height **84" (2134)**  
Depth **24" (610)**

Illustrations shown in stainless steel design.

SIDE-BY-SIDE

**Model 661**

**Model 642**

**Model 685**

*Ice / Water Dispensing*

**Model 632**

**Model 695**

*Ice / Water Dispensing*

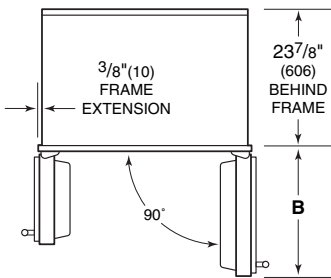

INSTALLATION SPECIFICATIONS

Side-by-Side Refrigerator / Freezer Models

**Model 661**

- A) Rough Opening Width **35 1/2" (902)**
- B) Min Door Clearance **20 3/4" (527)**

**Model 642**

- A) Rough Opening Width **41 1/2" (1054)**
- B) Min Door Clearance **25 9/16" (649)**

**Model 685**

- A) Rough Opening Width **41 1/2" (1054)**
- B) Min Door Clearance **25 9/16" (649)**

**Model 632**

- A) Rough Opening Width **47 1/2" (1206)**
- B) Min Door Clearance **29 1/4" (743)**

**Model 695**

- A) Rough Opening Width **47 1/2" (1206)**
- B) Min Door Clearance **29 1/4" (743)**

Dimensions are for finished rough openings.

Door swing clearances are based on stainless steel door and handle dimensions.

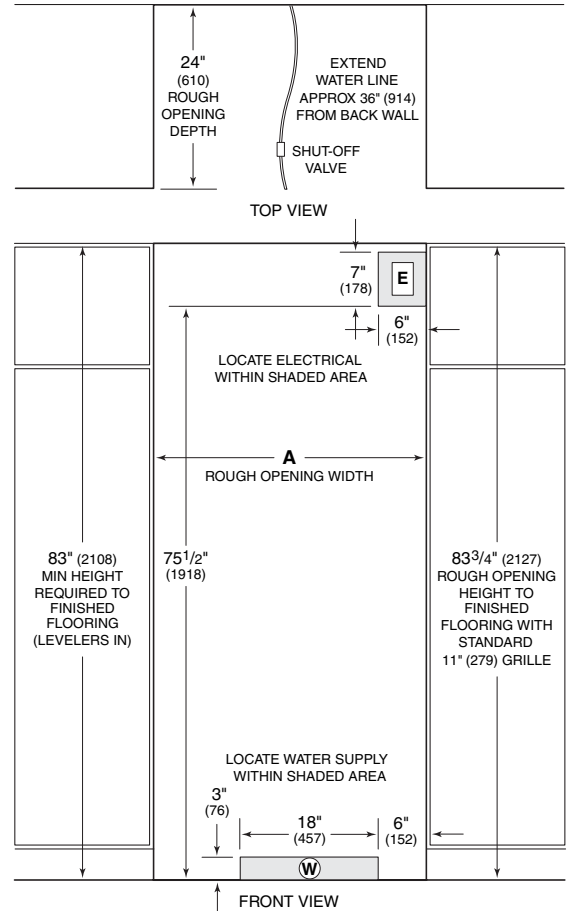

INSTALLATION

Refer to the installation instructions shipped with each Sub-Zero product for detailed specifications.



BUILT-IN

### OVERALL DIMENSIONS

PRO 48 Side-by-Side Refrigerator / Freezer Models

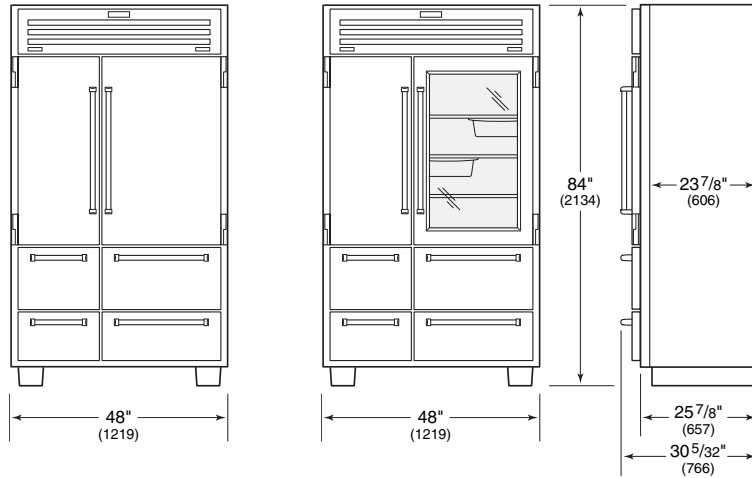

#### Model 648PRO

Width **48" (1219)**  
 Height **84" (2134)**  
 Depth **23 7/8" (606)\***  
**25 7/8" (657)\*\***

#### Model 648PROG with Glass Door

Width **48" (1219)**  
 Height **84" (2134)**  
 Depth **23 7/8" (606)\***  
**25 7/8" (657)\*\***

\*Depth from behind face frame to back of unit for standard installation.  
 \*\*Depth from front of face frame to back of unit for flush installation.

PRO 48  
SIDE-BY-SIDE

Model 648PRO  
Built-In or Free-Standing

Model 648PROG  
with Glass Door  
Built-In or Free-Standing

### INSTALLATION SPECIFICATIONS

PRO 48 Side-by-Side Refrigerator / Freezer Models  
Built-In or Free-Standing

Models 648PRO and 648PROG can be used free-standing or installed as a standard or flush built-in application. For standard built-in installations, the face frame of the unit will extend 2" (51) beyond cabinetry. In flush built-in installations, the front of the face frame will be flush with surrounding cabinetry.

Dimensions are for finished rough openings.

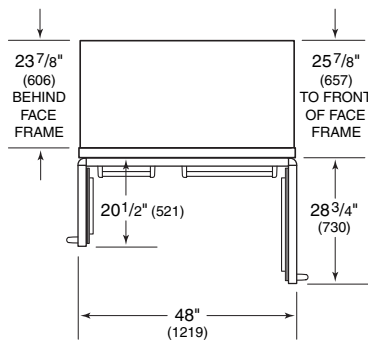

Dimensions in parentheses are in millimeters unless otherwise specified.

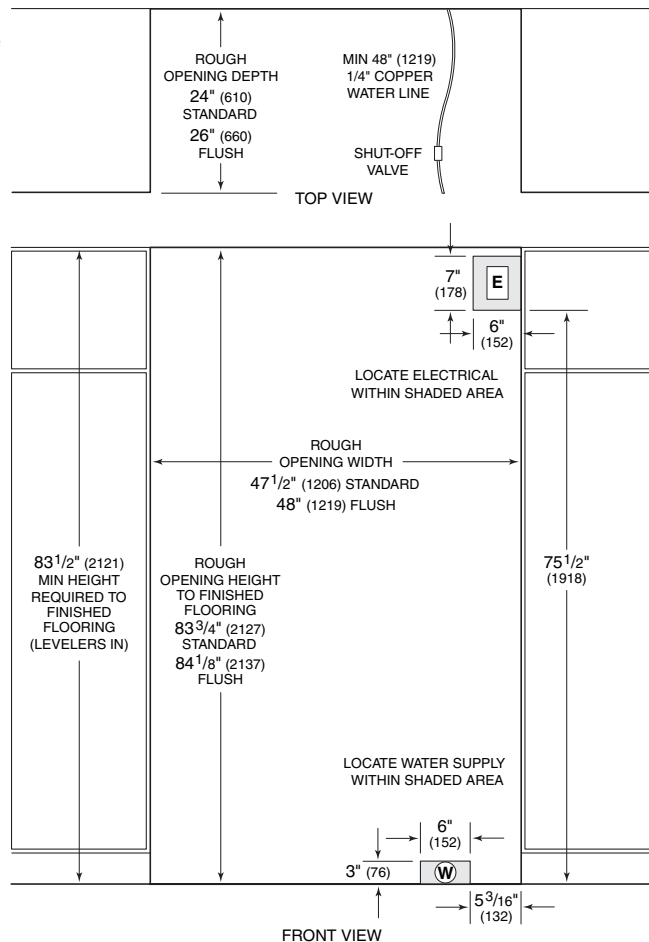

### INSTALLATION

Refer to the installation instructions shipped with each Sub-Zero product for detailed specifications.



BUILT-IN

### ANTI-TIP BLOCKING KIT

To prevent the unit from tipping forward and to provide a stable installation, the unit must be secured in place with an anti-tip blocking kit. If there is a solid soffit above the unit with clearance between the unit and the soffit of 1" (25) or less, you won't need to block the unit. But for installations with clearances of more than 1" (25), you must block the unit with the anti-tip blocking kit (wood block and hardware) provided with each Sub-Zero Built-In model. Refer to the Built-In Installation Guide packed with the appliance, which provides step-by-step procedures for making sure the unit is installed properly.

### ACCESSORIES

Optional accessories are available through your Sub-Zero dealer, or call Sub-Zero at 800-222-7820. You can also visit our website at [subzero.com](http://subzero.com) and click on the accessories section for your specific model.

### ADDING PANELS

In your plan for panels, be sure you are working with the Sub-Zero panel design family called for in your design. If you have chosen the stainless steel design, the unit will be shipped complete with wrapped stainless steel doors and handle hardware. You will not have to install door panels.

Specifications on the following pages provide panel dimensions and installation considerations for framed and overlay door panels.

Side panels can be used with the framed, overlay and stainless steel design applications. Refer to specifications on page 24.

### FRAMED DOOR PANELS

If you and your client have ordered a framed design model, you will be adding panels to give the unit the custom Sub-Zero look. The framed panel design option is available on all Built-In units except Models 648PRO and 648PROG. For exact door panel dimensions for Built-In framed models, refer to the Framed Panel Specifications on pages 20-21. Also refer to the full-scale illustrations at the end of this section for panel and handle considerations.

The traditional framed models come with an elegant, smooth, full-length handle. Optional extended full-length handles that provide additional finger clearance for raised panels are available through your Sub-Zero dealer.

If the thickness of the custom panels is less than 1/4" (6), they must be backed up with a sheet of shim material to build the total thickness to 1/4" (6). If the panel is thicker than 1/4" (6), an edge must be routed around the panel to ensure a proper fit. Refer to illustrations 1 and 2.

**IMPORTANT NOTE:** On all framed models, routing, recessing or optional extended handles may be required on raised panels for finger clearance under the handle. Refer to the full-scale illustrations at the end of this section.

For glass door Models 601RG, 611G and 650G, the refrigerator door panel must include a cut-out to accommodate the window. Refer to the Framed Panel Specifications on pages 20-21.

**IMPORTANT NOTE:** On glass door models, the glass portion of the door must be exposed and not covered by any part of the panel.

For Models 685 and 695, the refrigerator door panel must include a cut-out to accommodate the glasswell and bezel. The thickness of the panel in this area can range from 1/4" (6) to a maximum of 1 1/8" (29). If the panel is thicker, provisions must be made to rout out a space to accommodate the decorative bezel surrounding the glasswell.

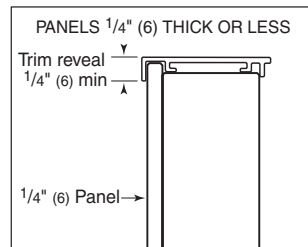

Illus. 1

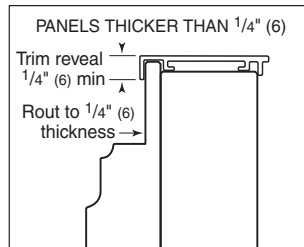

Illus. 2



BUILT-IN

### GLASSWELL PANEL OPTIONS

If you choose not to use custom wood panels above or below the glasswell for Model 685 or 695 framed application, a stainless steel insert panel will be provided with the partial framed accessory kit. This accessory kit (FRAMPAR), includes partial framed molding and classic stainless steel inset handle panel to provide a spill-resistant finish above and below the glasswell on the refrigerator door only. Refer to the Framed Panel Specifications for this option on page 21.

With the framed retrofit accessory kit, existing Model 680 or 690 door panels can be used on a new Model 685 or 695 framed unit. This accessory kit (FRAMRET) includes framed retrofit moldings and classic stainless steel inset handle panels to accommodate existing Model 680 or 690 framed refrigerator and freezer door panels.

Both accessory kits are available through your Sub-Zero dealer. See illustrations below.

### OPTIONAL PANEL GRILLE

An 11" (279) louvered grille is standard on framed applications. Optional louvered grilles are available in 1" (25) height increments from 10" (254) to 15" (381) for all Built-In models except Models 601R, 601RG, 601F, 648PRO and 648PROG.

You may choose to use Sub-Zero's optional panel grille for some of your framed applications. The panel grilles can be used with all Built-In models except Models 601R, 601RG, 601F, 648PRO and 648PROG and are available in 1" (25) height increments from 10" (254) to 15" (381).

For each model, the width of the panel grille will be the same, regardless of the height you have chosen. To determine the panel grille insert size, use the width dimension listed for your model and the height dimension for the grille option you have chosen. Specifications for the Panel Grille Option are listed on page 21.

#### PANEL REQUIREMENTS

The weight of each framed door panel cannot exceed 50 lbs (23 kg).

#### INSTALLATION

To install framed panels, see the detailed procedures outlined in the Sub-Zero Built-In Installation Guide.



Partial Framed Kit  
FRAMPAR



Framed Retrofit Kit  
FRAMRET

Dimensions in parentheses are in millimeters unless otherwise specified.



**FRAMED DOOR PANEL SPECIFICATIONS**

*All Refrigerator / All Freezer Framed (F) Models*

<b>Model 601R</b>	<b>W</b>	<b>H</b>
Refrigerator Framed Panel	<b>34<sup>1</sup>/<sub>8</sub>" (867)</b>	<b>58<sup>15</sup>/<sub>16</sub>" (1497)</b>
Raised Panel Handle Recess Location -		
Refrigerator Panel	<b>A) 29<sup>15</sup>/<sub>32</sub>" (749)</b>	
<b>Model 601RG</b>	<b>W</b>	<b>H</b>
Refrigerator Framed Panel	<b>34<sup>1</sup>/<sub>8</sub>" (867)</b>	<b>58<sup>15</sup>/<sub>16</sub>" (1497)</b>
Raised Panel Handle Recess Location -		
Refrigerator Panel	<b>A) 29<sup>15</sup>/<sub>32</sub>" (749)</b>	
Window Cut-out Dimensions	<b>25<sup>3</sup>/<sub>8</sub>" (645)</b>	<b>41<sup>3</sup>/<sub>16</sub>" (1046)</b>
Window Cut-out Location	<b>C) 4<sup>3</sup>/<sub>8</sub>" (111)</b>	<b>D) 13<sup>3</sup>/<sub>8</sub>" (340)</b>
<b>Model 601F</b>	<b>W</b>	<b>H</b>
Freezer Framed Panel	<b>34<sup>1</sup>/<sub>8</sub>" (867)</b>	<b>58<sup>15</sup>/<sub>16</sub>" (1497)</b>
Raised Panel Handle Recess Location -		
Freezer Panel	<b>A) 29<sup>15</sup>/<sub>32</sub>" (749)</b>	

*IMPORTANT NOTE: Panel specifications are for Built-In framed (F) models. Panel specifications for overlay models are on pages 25-26.*

**FRAMED DOOR PANEL SPECIFICATIONS**

*Over-and-Under Framed (F) Models*

<b>Model 611</b>	<b>W</b>	<b>H</b>
Refrigerator Framed Panel	<b>28<sup>1</sup>/<sub>8</sub>" (714)</b>	<b>48<sup>1</sup>/<sub>16</sub>" (1221)</b>
Freezer Framed Panel	<b>28<sup>1</sup>/<sub>8</sub>" (714)</b>	<b>18<sup>3</sup>/<sub>8</sub>" (467)</b>
Raised Panel Handle Recess Location -		
Refrigerator Panel	<b>A) 24<sup>1</sup>/<sub>32</sub>" (610)</b>	
Freezer Panel	<b>B) 14<sup>1</sup>/<sub>16</sub>" (357)</b>	
<b>Model 611G</b>	<b>W</b>	<b>H</b>
Refrigerator Framed Panel	<b>28<sup>1</sup>/<sub>8</sub>" (714)</b>	<b>48<sup>1</sup>/<sub>16</sub>" (1221)</b>
Freezer Framed Panel	<b>28<sup>1</sup>/<sub>8</sub>" (714)</b>	<b>18<sup>3</sup>/<sub>8</sub>" (467)</b>
Raised Panel Handle Recess Location -		
Refrigerator Panel	<b>A) 24<sup>1</sup>/<sub>32</sub>" (610)</b>	
Freezer Panel	<b>B) 14<sup>1</sup>/<sub>16</sub>" (357)</b>	
Window Cut-out Dimensions	<b>19<sup>3</sup>/<sub>8</sub>" (492)</b>	<b>39<sup>5</sup>/<sub>16</sub>" (999)</b>
Window Cut-out Location	<b>C) 4<sup>3</sup>/<sub>8</sub>" (111)</b>	<b>D) 4<sup>3</sup>/<sub>8</sub>" (111)</b>
<b>Model 650</b>	<b>W</b>	<b>H</b>
Refrigerator Framed Panel	<b>34<sup>1</sup>/<sub>8</sub>" (867)</b>	<b>48<sup>1</sup>/<sub>16</sub>" (1221)</b>
Freezer Framed Panel	<b>34<sup>1</sup>/<sub>8</sub>" (867)</b>	<b>18<sup>3</sup>/<sub>8</sub>" (467)</b>
Raised Panel Handle Recess Location -		
Refrigerator Panel	<b>A) 24<sup>1</sup>/<sub>32</sub>" (610)</b>	
Freezer Panel	<b>B) 17<sup>1</sup>/<sub>16</sub>" (433)</b>	
<b>Model 650G</b>	<b>W</b>	<b>H</b>
Refrigerator Framed Panel	<b>34<sup>1</sup>/<sub>8</sub>" (867)</b>	<b>48<sup>1</sup>/<sub>16</sub>" (1221)</b>
Freezer Framed Panel	<b>34<sup>1</sup>/<sub>8</sub>" (867)</b>	<b>18<sup>3</sup>/<sub>8</sub>" (467)</b>
Raised Panel Handle Recess Location -		
Refrigerator Panel	<b>A) 24<sup>1</sup>/<sub>32</sub>" (610)</b>	
Freezer Panel	<b>B) 17<sup>1</sup>/<sub>16</sub>" (433)</b>	
Window Cut-out Dimensions	<b>25<sup>3</sup>/<sub>8</sub>" (645)</b>	<b>39<sup>5</sup>/<sub>16</sub>" (999)</b>
Window Cut-out Location	<b>C) 4<sup>3</sup>/<sub>8</sub>" (111)</b>	<b>D) 4<sup>3</sup>/<sub>8</sub>" (111)</b>

*IMPORTANT NOTE: Panel specifications are for Built-In framed (F) models. Panel specifications for overlay models are on pages 25-26.*

**FRAMED PANELS**

**Panel specifications are for Built-In framed (F) models.**

**To install framed panels, see the detailed procedures outlined in the Sub-Zero Built-In Installation Guide.**

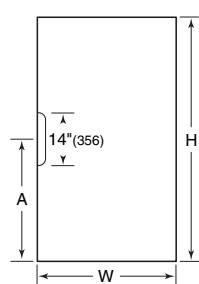

**Models 601R and 601F**

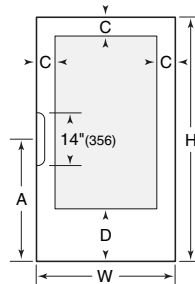

**Model 601RG**

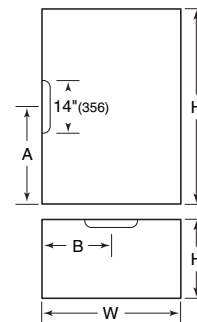

**Models 611 and 650**

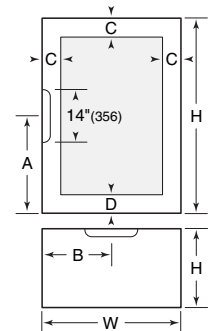

**Models 611G and 650G**



BUILT-IN

### FRAMED DOOR PANEL SPECIFICATIONS

#### Side-by-Side Framed (F) Models

Model 661	W	H
Refrigerator Framed Panel	19 <sup>1</sup> / <sub>8</sub> " (486)	67 <sup>11</sup> / <sub>16</sub> " (1719)
Freezer Framed Panel	14 <sup>5</sup> / <sub>8</sub> " (371)	67 <sup>11</sup> / <sub>16</sub> " (1719)

Raised Panel Handle Recess Location -

Refrigerator   Freezer Panel	A) 38 <sup>5</sup> / <sub>32</sub> " (969)
------------------------------	--

Model 642	W	H
Refrigerator Framed Panel	24" (610)	67 <sup>11</sup> / <sub>16</sub> " (1719)
Freezer Framed Panel	15 <sup>5</sup> / <sub>8</sub> " (397)	67 <sup>11</sup> / <sub>16</sub> " (1719)

Raised Panel Handle Recess Location -

Refrigerator   Freezer Panel	A) 38 <sup>5</sup> / <sub>32</sub> " (969)
------------------------------	--

Model 685	W	H
Refrigerator Framed Panel	24" (610)	67 <sup>11</sup> / <sub>16</sub> " (1719)
Freezer Framed Panel	15 <sup>5</sup> / <sub>8</sub> " (397)	67 <sup>11</sup> / <sub>16</sub> " (1719)
Glasswell Cut-out Dimensions	5 <sup>7</sup> / <sub>8</sub> " (150)	12 <sup>7</sup> / <sub>16</sub> " (315)
Glasswell Location (Refrigerator)	E) 1 <sup>9</sup> / <sub>16</sub> " (39)	F) 28 <sup>9</sup> / <sub>16</sub> " (726)

Model 632	W	H
Refrigerator Framed Panel	27 <sup>11</sup> / <sub>16</sub> " (703)	67 <sup>11</sup> / <sub>16</sub> " (1719)
Freezer Framed Panel	17 <sup>15</sup> / <sub>16</sub> " (456)	67 <sup>11</sup> / <sub>16</sub> " (1719)

Raised Panel Handle Recess Location -

Refrigerator   Freezer Panel	A) 38 <sup>5</sup> / <sub>32</sub> " (969)
------------------------------	--

Model 695	W	H
Refrigerator Framed Panel	27 <sup>11</sup> / <sub>16</sub> " (703)	67 <sup>11</sup> / <sub>16</sub> " (1719)
Freezer Framed Panel	17 <sup>15</sup> / <sub>16</sub> " (456)	67 <sup>11</sup> / <sub>16</sub> " (1719)
Glasswell Cut-out Dimensions	5 <sup>7</sup> / <sub>8</sub> " (150)	12 <sup>7</sup> / <sub>16</sub> " (315)
Glasswell Location (Refrigerator)	E) 1 <sup>9</sup> / <sub>16</sub> " (39)	F) 28 <sup>9</sup> / <sub>16</sub> " (726)

**IMPORTANT NOTE:** Panel specifications are for Built-In framed (F) models. Panel specifications for overlay models are on pages 25-26.

For Models 685 and 695, panel thickness in the glasswell area can range from 1/4" (6) to a maximum of 1 1/8" (29). If the panel is thicker, you must rout out a minimum 1/4" (6) flat landing area to accommodate the bezel surrounding the glasswell.

### PARTIAL FRAMED DOOR PANEL OPTION

#### Ice | Water Dispensing Framed (F) Models

Model 685	W	H
Refrigerator Partial Framed Panel	15 <sup>5</sup> / <sub>8</sub> " (397)	67 <sup>11</sup> / <sub>16</sub> " (1719)
Freezer Partial Framed Panel	15 <sup>5</sup> / <sub>8</sub> " (397)	67 <sup>11</sup> / <sub>16</sub> " (1719)

Model 695	W	H
Refrigerator Partial Framed Panel	17 <sup>15</sup> / <sub>16</sub> " (456)	67 <sup>11</sup> / <sub>16</sub> " (1719)
Freezer Partial Framed Panel	17 <sup>15</sup> / <sub>16</sub> " (456)	67 <sup>11</sup> / <sub>16</sub> " (1719)

The partial framed accessory kit (FRAMPAR) is required for this option. Kit includes partial framed molding and classic stainless steel inset handle panels for above and below glasswell on the refrigerator door.

### PANEL GRILLE OPTION

#### Framed (F) Models

Models 611 and 611G	W
Grille Panel Width	28 <sup>3</sup> / <sub>16</sub> " (716)

Models 650, 650G, 661	W
Grille Panel Width	34 <sup>3</sup> / <sub>16</sub> " (868)

Models 642 and 685	W
Grille Panel Width	40 <sup>3</sup> / <sub>16</sub> " (1021)

Models 632 and 695	W
Grille Panel Width	46 <sup>3</sup> / <sub>16</sub> " (1173)

10" (254) Grille	H
Grille Panel Height	8 <sup>15</sup> / <sub>16</sub> " (227)

11" (279) Grille (standard)	H
Grille Panel Height	9 <sup>15</sup> / <sub>16</sub> " (252)

12" (305) Grille Height	H
Grille Panel Height	10 <sup>15</sup> / <sub>16</sub> " (278)

13" (330) Grille	H
Grille Panel Height	11 <sup>15</sup> / <sub>16</sub> " (303)

14" (356) Grille	H
Grille Panel Height	12 <sup>15</sup> / <sub>16</sub> " (329)

15" (381) Grille	H
Grille Panel Height	13 <sup>15</sup> / <sub>16</sub> " (354)

For panel grille insert size, use width dimension listed for your model and height dimension for grille option. 11" (279) grille is standard.

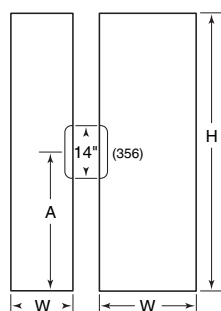

Models 661, 642 and 632

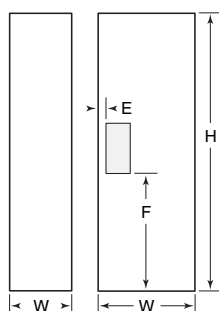

Models 685 and 695

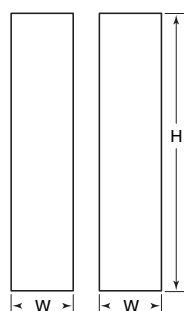

Models 685 and 695 Partial Framed Option

### FRAMED PANELS

Panel specifications are for Built-In framed (F) models.

To install framed panels, see the detailed procedures outlined in the Sub-Zero Built-In Installation Guide.

Dimensions in parentheses are in millimeters unless otherwise specified.



BUILT-IN

## OVERLAY DOOR PANELS

If you and your client have ordered an overlay design model, you will be adding panels to give the unit the custom Sub-Zero look. The overlay panel design option is available on all Built-In units except Models 648PRO and 648PROG.

For exact door panel dimensions for Built-In overlay models, refer to the Overlay Panel Specifications on pages 25–26.

The overlay design allows decorative panels to cover the door trim for a more seamless appearance that blends with the design of the room. To achieve this look, the most common way is to work with three panels—the decorative overlay panel, a 0.10" (3) spacer panel and a 1/4" (6) backer panel. Depending on your cabinet manufacturer, this could be one panel routed for different dimensions or, more likely, three different panels.

Regardless of the physical construction of the panels (routing or three-panel assembly), you will need to follow the Overlay Panel Specifications on the following pages for exact sizing and panel placement to ensure a proper fit.

Illustration 3 is a cross section view of the three-panel assembly showing placement of the door, drawer or grille trim. Illustration 4 shows a rear view of the three-panel assembly and critical dimensions, standard for all models.

**IMPORTANT NOTE:** Keep in mind that the Sub-Zero door panels have the potential for hitting adjacent cabinets and/or countertops when they are opened. You need to be aware of your surrounding cabinetry and space limitations when using the overlay models. Refer to the full-scale illustrations at the end of this section.

If you are using an overlay door panel with Model 601R, 601RG, 601F, 611, 611G, 650 or 650G, it is necessary to rout a space for the unit's lower hinge plate so it does not strike the door panel. Refer to illustration 5.

For Models 611, 611G, 650 and 650G, you will minimize the reveal between the bottom of the overlay door panel and the top of the overlay drawer panel. Refer to illustration 6.

**IMPORTANT NOTE:** If you choose not to rout a space for the lower hinge plate, you can reduce the total height of the overlay panel (decorative panel only) by 1/2" (13).

### CAUTION

**Do not exceed the overlay decorative panel dimensions for Models 611, 611G, 650 or 650G listed on page 25. If you try to make the reveal tighter between the door and drawer panels, the panels may hit when opening and closing, causing possible damage to the panels and the Sub-Zero unit.**

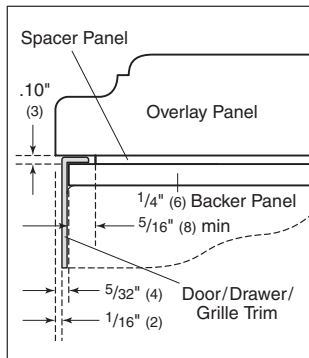

Illus. 3

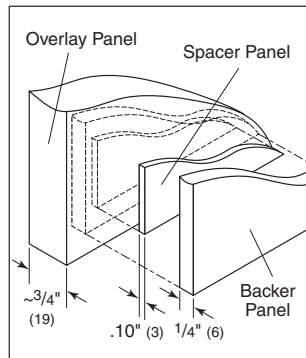

Illus. 4

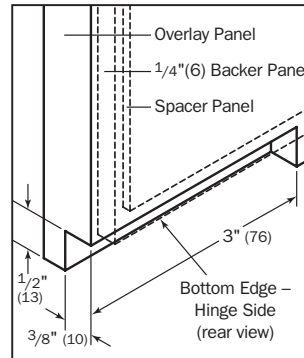

Illus. 5

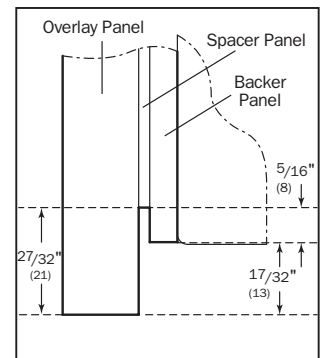

Illus. 6



BUILT-IN

## OVERLAY DOOR PANELS

For glass door Models 601RG, 611G and 650G, the refrigerator door panel must include a cut-out to accommodate the window. Refer to the Overlay Panel Specifications for Models 601RG, 611G and 650G on page 25.

**IMPORTANT NOTE:** On glass door models, the glass portion of the door must be exposed and not covered by any part of the panel.

For Models 685 and 695, the refrigerator door panel must include a cut-out to accommodate the glasswell and bezel. The thickness of the panel in this area can range from 1/4" (6) to a maximum of 1 1/8" (29).

**IMPORTANT NOTE:** Regardless of the thickness of the overlay panel for Model 685 or 695, you must plan for a flat 'landing' space for the decorative bezel surrounding the glasswell area. Refer to page 26 for exact cut-out dimensions of the glasswell area in the overlay, spacer and backer panels. This 'landing' area can be accomplished in a number of different ways. We are showing two in Illustrations 7 and 8 below.

Illustration 7 shows how you can recess the bezel to the inset panel. You must rout out a space to accommodate the 12 7/8" (327) height of the bezel. Also keep in mind that the amount of material you will rout out of the stile will vary because of the thickness of this element. However, the width of the stile immediately adjacent to the bezel must be 1 7/16" (37). DO NOT cut the entire stile to this dimension. In this illustration you can see that rails above and below the bezel give this a finished look. Make sure that the bezel is not supporting weight from the panel.

Illustration 8 shows how you can box out a landing space for the bezel using stiles and rails to create this space. Again, keep in mind, that the total thickness of the panel at this level must not exceed 1 1/8" (29).

## OVERLAY PANEL GRILLE

Overlay grille panels for the panel grille match the design of the door panels. Overlay units, except Models 601R, 601RG and 601F, come standard with an 11" (279) panel grille. Optional grilles are available in 1" (25) height increments from 10" (254) to 15" (381). Overlay grille panel specifications for the panel grille are listed on page 26. Also refer to illustration 4 on page 22 for additional overlay panel dimensions.

## INSTALLATION

To install overlay panels, see the detailed procedures outlined in the Sub-Zero Built-In Installation Guide.

### ⚠ CAUTION

Do not exceed the panel dimensions listed for the appropriate overlay grille panel you are specifying. The decorative panel cannot be any larger or it may restrict the airflow to the compressor area and cause problems with the operation of the Sub-Zero unit.

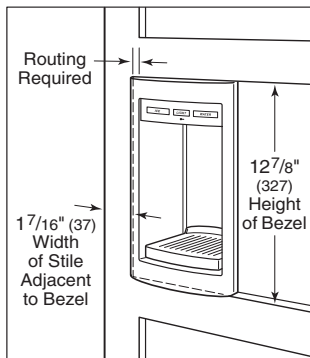

Illus. 7

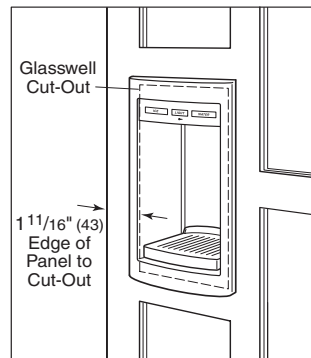

Illus. 8

Dimensions in parentheses are in millimeters unless otherwise specified.



BUILT-IN

## HANDLE HARDWARE

Overlay models come without handle hardware. The beauty of this design is that you can match the surrounding cabinet hardware. You or the cabinet manufacturer must provide handle hardware to match the overall decorating scheme.

The handle hardware must be installed before installing the panel assembly. Use larger D-style handles. If screws with thick heads are used, the screws will need to be countersunk into the door before the panel is put into place.

**IMPORTANT NOTE:** Sub-Zero does not recommend using single pull knobs on any of its Built-In models.

For overlay Models 685 and 695, mounting placement of the refrigerator door handle must assure proper access to the glasswell and adequate clearance under the handle. Illustration 8 shows placement of the refrigerator door handle in relationship to the glasswell bezel on stainless steel models.

Optional stainless steel handles are available in a variety of diameters and lengths, as are handles to match the color and style of Wolf ovens. Contact your Sub-Zero dealer for specifics.

Refer to the full-scale illustrations at the end of this section for handle hardware considerations.

## ACCESSORIES

Optional accessories are available through your Sub-Zero dealer, or call Sub-Zero at 800-222-7820. You can also visit our website at [subzero.com](http://subzero.com) and click on the accessories section for your specific model.

## INSTALLATION

To install overlay panels, see the detailed procedures outlined in the Sub-Zero Built-In Installation Guide.

## SIDE PANELS

Side panels can be used with the framed, overlay and stainless steel design applications. When planning for side panels with the installation of a Built-In model, you need to be aware of space configuration to achieve a pleasing fit. Depending on the exact panel you are using with your unit, the height of the panel will vary.

Cut-outs around the kickplate and grille area are required if a 1/4" (6) thick panel will be inserted into the main frame channel. The panel will need to be 24" (610) deep. Refer to illustration 9 for placement of cut-outs. If a 3/8" (10) thick panel is used, the panel will abut the main frame and should be 23 7/8" (606) deep. The toe kick area may or may not be cut out depending on the look you want to achieve. These dimensions do not apply to Models 648PRO and 648PROG.

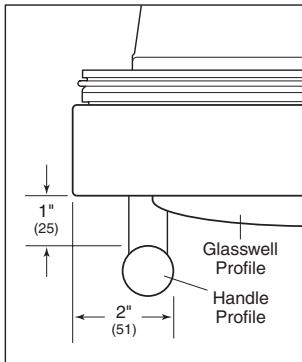

Illus. 8

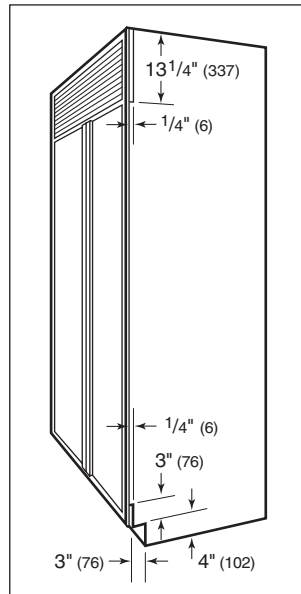

Illus. 9

## SERVICE INFORMATION

**Sub-Zero Freezer Co., Inc.**  
**Customer Service Department**

**P. O. Box 44130**  
**Madison, WI 53744-4130**

**Service line: 800-222-7820**

**E-mail: [customerservice@subzero.com](mailto:customerservice@subzero.com)**

**Website: [subzero.com](http://subzero.com)**

*If service is necessary, contact customer service by phone or e-mail and include the model and serial number.*

*Make sure that product registration forms are filled out and returned, to assure that your information is in our database.*

*Dimensions in parentheses are in millimeters unless otherwise specified.*



BUILT-IN

OVERLAY DOOR PANEL SPECIFICATIONS

All Refrigerator / All Freezer Overlay (O) Models

Model 601R	W	H
Refrigerator Overlay Panel	34 <sup>7</sup> / <sub>16</sub> " (875)	59 <sup>1</sup> / <sub>4</sub> " (1505)
Refrigerator Spacer Panel	33 <sup>1</sup> / <sub>2</sub> " (851)	58 <sup>5</sup> / <sub>16</sub> " (1481)
Refrigerator Backer Panel	34 <sup>1</sup> / <sub>8</sub> " (867)	58 <sup>15</sup> / <sub>16</sub> " (1497)

Model 601RG	W	H
Refrigerator Overlay Panel	34 <sup>7</sup> / <sub>16</sub> " (875)	59 <sup>1</sup> / <sub>4</sub> " (1505)
Refrigerator Spacer Panel	33 <sup>1</sup> / <sub>2</sub> " (851)	58 <sup>5</sup> / <sub>16</sub> " (1481)
Refrigerator Backer Panel	34 <sup>1</sup> / <sub>8</sub> " (867)	58 <sup>15</sup> / <sub>16</sub> " (1497)
Window Cut-out Dimensions	25 <sup>7</sup> / <sub>16</sub> " (646)	41 <sup>1</sup> / <sub>4</sub> " (1048)
Window Cut-out Location	C) 4 <sup>1</sup> / <sub>2</sub> " (114) D) 13 <sup>1</sup> / <sub>2</sub> " (343)	

Model 601F	W	H
Freezer Overlay Panel	34 <sup>7</sup> / <sub>16</sub> " (875)	59 <sup>1</sup> / <sub>4</sub> " (1505)
Freezer Spacer Panel	33 <sup>1</sup> / <sub>2</sub> " (851)	58 <sup>5</sup> / <sub>16</sub> " (1481)
Freezer Backer Panel	34 <sup>1</sup> / <sub>8</sub> " (867)	58 <sup>15</sup> / <sub>16</sub> " (1497)

IMPORTANT NOTE: Panel specifications are for Built-In overlay (O) models. Panel specifications for framed models are on pages 20-21.

OVERLAY DOOR PANEL SPECIFICATIONS

Over-and-Under Overlay (O) Models

Model 611	W	H
Refrigerator Overlay Panel	28 <sup>7</sup> / <sub>16</sub> " (722)	48 <sup>7</sup> / <sub>8</sub> " (1241)
Refrigerator Spacer Panel	27 <sup>1</sup> / <sub>2</sub> " (699)	47 <sup>7</sup> / <sub>16</sub> " (1205)
Refrigerator Backer Panel	28 <sup>1</sup> / <sub>8</sub> " (714)	48 <sup>1</sup> / <sub>16</sub> " (1221)
Freezer Overlay Panel	28 <sup>7</sup> / <sub>16</sub> " (722)	18 <sup>11</sup> / <sub>16</sub> " (475)
Freezer Spacer Panel	27 <sup>1</sup> / <sub>2</sub> " (699)	17 <sup>3</sup> / <sub>4</sub> " (451)
Freezer Backer Panel	28 <sup>1</sup> / <sub>8</sub> " (714)	18 <sup>3</sup> / <sub>8</sub> " (467)

Model 611G	W	H
Refrigerator Overlay Panel	28 <sup>7</sup> / <sub>16</sub> " (722)	48 <sup>7</sup> / <sub>8</sub> " (1241)
Refrigerator Spacer Panel	27 <sup>1</sup> / <sub>2</sub> " (699)	47 <sup>7</sup> / <sub>16</sub> " (1205)
Refrigerator Backer Panel	28 <sup>1</sup> / <sub>8</sub> " (714)	48 <sup>1</sup> / <sub>16</sub> " (1221)
Freezer Overlay Panel	28 <sup>7</sup> / <sub>16</sub> " (722)	18 <sup>11</sup> / <sub>16</sub> " (475)
Freezer Spacer Panel	27 <sup>1</sup> / <sub>2</sub> " (699)	17 <sup>3</sup> / <sub>4</sub> " (451)
Freezer Backer Panel	28 <sup>1</sup> / <sub>8</sub> " (714)	18 <sup>3</sup> / <sub>8</sub> " (467)
Window Cut-out Dimensions	19 <sup>7</sup> / <sub>16</sub> " (494)	39 <sup>3</sup> / <sub>8</sub> " (1000)
Window Cut-out Location	C) 4 <sup>1</sup> / <sub>2</sub> " (114) D) 5" (127)	

Model 650	W	H
Refrigerator Overlay Panel	34 <sup>7</sup> / <sub>16</sub> " (875)	48 <sup>7</sup> / <sub>8</sub> " (1241)
Refrigerator Spacer Panel	33 <sup>1</sup> / <sub>2</sub> " (851)	47 <sup>7</sup> / <sub>16</sub> " (1205)
Refrigerator Backer Panel	34 <sup>1</sup> / <sub>8</sub> " (867)	48 <sup>1</sup> / <sub>16</sub> " (1221)
Freezer Overlay Panel	34 <sup>7</sup> / <sub>16</sub> " (875)	18 <sup>11</sup> / <sub>16</sub> " (475)
Freezer Spacer Panel	33 <sup>1</sup> / <sub>2</sub> " (851)	17 <sup>3</sup> / <sub>4</sub> " (451)
Freezer Backer Panel	34 <sup>1</sup> / <sub>8</sub> " (867)	18 <sup>3</sup> / <sub>8</sub> " (467)

Model 650G	W	H
Refrigerator Overlay Panel	34 <sup>7</sup> / <sub>16</sub> " (875)	48 <sup>7</sup> / <sub>8</sub> " (1241)
Refrigerator Spacer Panel	33 <sup>1</sup> / <sub>2</sub> " (851)	47 <sup>7</sup> / <sub>16</sub> " (1205)
Refrigerator Backer Panel	34 <sup>1</sup> / <sub>8</sub> " (867)	48 <sup>1</sup> / <sub>16</sub> " (1221)
Freezer Overlay Panel	34 <sup>7</sup> / <sub>16</sub> " (875)	18 <sup>11</sup> / <sub>16</sub> " (475)
Freezer Spacer Panel	33 <sup>1</sup> / <sub>2</sub> " (851)	17 <sup>3</sup> / <sub>4</sub> " (451)
Freezer Backer Panel	34 <sup>1</sup> / <sub>8</sub> " (867)	18 <sup>3</sup> / <sub>8</sub> " (467)
Window Cut-out Dimensions	25 <sup>7</sup> / <sub>16</sub> " (646)	39 <sup>3</sup> / <sub>8</sub> " (1000)
Window Cut-out Location	C) 4 <sup>1</sup> / <sub>2</sub> " (114) D) 5" (127)	

IMPORTANT NOTE: Panel specifications are for Built-In overlay (O) models. Panel specifications for framed models are on pages 20-21.

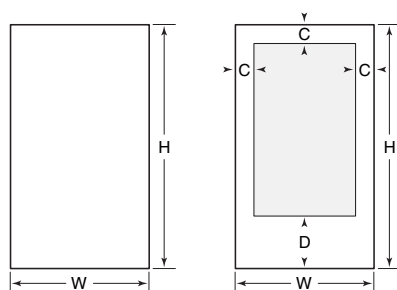

Models 601R and 601F

Model 601RG

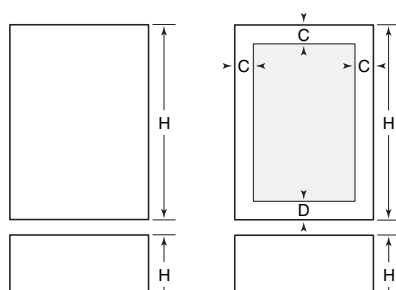

Models 611 and 650

Models 611G and 650G

OVERLAY PANELS

Panel specifications are for Built-In overlay (O) models.

To install overlay panels, see the detailed procedures outlined in the Sub-Zero Built-In Installation Guide.

Dimensions in parentheses are in millimeters unless otherwise specified.



**BUILT-IN**

**OVERLAY DOOR PANEL SPECIFICATIONS**

*Side-by-Side Overlay (O) Models*

<b>Model 661</b>	<b>W</b>	<b>H</b>
Refrigerator Overlay Panel	19 <sup>7</sup> / <sub>16</sub> " (494)	68" (1727)
Refrigerator Spacer Panel	18 <sup>1</sup> / <sub>2</sub> " (470)	67 <sup>1</sup> / <sub>16</sub> " (1703)
Refrigerator Backer Panel	19 <sup>1</sup> / <sub>8</sub> " (486)	67 <sup>11</sup> / <sub>16</sub> " (1719)
Freezer Overlay Panel	14 <sup>15</sup> / <sub>16</sub> " (379)	68" (1727)
Freezer Spacer Panel	14" (356)	67 <sup>1</sup> / <sub>16</sub> " (1703)
Freezer Backer Panel	14 <sup>5</sup> / <sub>8</sub> " (371)	67 <sup>11</sup> / <sub>16</sub> " (1719)

<b>Model 642</b>	<b>W</b>	<b>H</b>
Refrigerator Overlay Panel	24 <sup>5</sup> / <sub>16</sub> " (618)	68" (1727)
Refrigerator Spacer Panel	23 <sup>3</sup> / <sub>8</sub> " (594)	67 <sup>1</sup> / <sub>16</sub> " (1703)
Refrigerator Backer Panel	24" (610)	67 <sup>11</sup> / <sub>16</sub> " (1719)
Freezer Overlay Panel	15 <sup>15</sup> / <sub>16</sub> " (405)	68" (1727)
Freezer Spacer Panel	15" (381)	67 <sup>1</sup> / <sub>16</sub> " (1703)
Freezer Backer Panel	15 <sup>5</sup> / <sub>8</sub> " (397)	67 <sup>11</sup> / <sub>16</sub> " (1719)

<b>Model 685</b>	<b>W</b>	<b>H</b>
Refrigerator Overlay Panel	24 <sup>5</sup> / <sub>16</sub> " (618)	68" (1727)
Refrigerator Spacer Panel	23 <sup>3</sup> / <sub>8</sub> " (594)	67 <sup>1</sup> / <sub>16</sub> " (1703)
Refrigerator Backer Panel	24" (610)	67 <sup>11</sup> / <sub>16</sub> " (1719)
Freezer Overlay Panel	15 <sup>15</sup> / <sub>16</sub> " (405)	68" (1727)
Freezer Spacer Panel	15" (381)	67 <sup>1</sup> / <sub>16</sub> " (1703)
Freezer Backer Panel	15 <sup>5</sup> / <sub>8</sub> " (397)	67 <sup>11</sup> / <sub>16</sub> " (1719)

Glasswell Cut-out Dimensions	5 <sup>7</sup> / <sub>8</sub> " (150)	12 <sup>7</sup> / <sub>16</sub> " (315)
Glasswell Location (Overlay)	E) 1 <sup>11</sup> / <sub>16</sub> " (43)	F) 28 <sup>3</sup> / <sub>4</sub> " (730)
Glasswell Location (Spacer)	E) 1 <sup>1</sup> / <sub>4</sub> " (31)	F) 28 <sup>1</sup> / <sub>4</sub> " (718)
Glasswell Location (Backer)	E) 1 <sup>9</sup> / <sub>16</sub> " (39)	F) 28 <sup>9</sup> / <sub>16</sub> " (726)

<b>Model 632</b>	<b>W</b>	<b>H</b>
Refrigerator Overlay Panel	28" (711)	68" (1727)
Refrigerator Spacer Panel	27 <sup>1</sup> / <sub>16</sub> " (687)	67 <sup>1</sup> / <sub>16</sub> " (1703)
Refrigerator Backer Panel	27 <sup>11</sup> / <sub>16</sub> " (703)	67 <sup>11</sup> / <sub>16</sub> " (1719)
Freezer Overlay Panel	18 <sup>1</sup> / <sub>4</sub> " (464)	68" (1727)
Freezer Spacer Panel	17 <sup>5</sup> / <sub>16</sub> " (440)	67 <sup>1</sup> / <sub>16</sub> " (1703)
Freezer Backer Panel	17 <sup>15</sup> / <sub>16</sub> " (456)	67 <sup>11</sup> / <sub>16</sub> " (1719)

<b>Model 695</b>	<b>W</b>	<b>H</b>
Refrigerator Overlay Panel	28" (711)	68" (1727)
Refrigerator Spacer Panel	27 <sup>1</sup> / <sub>16</sub> " (687)	67 <sup>1</sup> / <sub>16</sub> " (1703)
Refrigerator Backer Panel	27 <sup>11</sup> / <sub>16</sub> " (703)	67 <sup>11</sup> / <sub>16</sub> " (1719)
Freezer Overlay Panel	18 <sup>1</sup> / <sub>4</sub> " (464)	68" (1727)
Freezer Spacer Panel	17 <sup>5</sup> / <sub>16</sub> " (440)	67 <sup>1</sup> / <sub>16</sub> " (1703)
Freezer Backer Panel	17 <sup>15</sup> / <sub>16</sub> " (456)	67 <sup>11</sup> / <sub>16</sub> " (1719)

Glasswell Cut-out Dimensions	5 <sup>7</sup> / <sub>8</sub> " (150)	12 <sup>7</sup> / <sub>16</sub> " (315)
Glasswell Location (Overlay)	E) 1 <sup>11</sup> / <sub>16</sub> " (43)	F) 28 <sup>3</sup> / <sub>4</sub> " (730)
Glasswell Location (Spacer)	E) 1 <sup>1</sup> / <sub>4</sub> " (31)	F) 28 <sup>1</sup> / <sub>4</sub> " (718)
Glasswell Location (Backer)	E) 1 <sup>9</sup> / <sub>16</sub> " (39)	F) 28 <sup>9</sup> / <sub>16</sub> " (726)

**IMPORTANT NOTE:** Panel specifications are for Built-In overlay (O) models. Panel specifications for framed models are on pages 20-21.

For Models 685 and 695, panel thickness in the glasswell area can range from 1/4" (6) to a maximum of 1/8" (29). If the panel is thicker, you must rout out a minimum 1/4" (6) flat landing area to accommodate the bezel surrounding the glasswell.

**OVERLAY GRILLE PANEL**

*Overlay (O) Models*

*Width Dimensions*

<b>Models 611 and 611G</b>	<b>W</b>
Overlay Panel Width	28 <sup>7</sup> / <sub>16</sub> " (722)
Spacer Panel Width	27 <sup>1</sup> / <sub>2</sub> " (699)
Backer Panel Width	28 <sup>1</sup> / <sub>8</sub> " (714)

<b>Models 650, 650G, 661</b>	<b>W</b>
Overlay Panel Width	34 <sup>7</sup> / <sub>16</sub> " (875)
Spacer Panel Width	33 <sup>1</sup> / <sub>2</sub> " (851)
Backer Panel Width	34 <sup>1</sup> / <sub>8</sub> " (867)

<b>Models 642 and 685</b>	<b>W</b>
Overlay Panel Width	40 <sup>7</sup> / <sub>16</sub> " (1027)
Spacer Panel Width	39 <sup>1</sup> / <sub>2</sub> " (1003)
Backer Panel Width	40 <sup>1</sup> / <sub>8</sub> " (1019)

<b>Models 632 and 695</b>	<b>W</b>
Overlay Panel Width	46 <sup>7</sup> / <sub>16</sub> " (1180)
Spacer Panel Width	45 <sup>1</sup> / <sub>2</sub> " (1156)
Backer Panel Width	46 <sup>1</sup> / <sub>8</sub> " (1172)

*Height Dimensions*

<b>10" (254) Grille</b>	<b>H</b>
Overlay Panel Height	9 <sup>1</sup> / <sub>4</sub> " (235)
Spacer Panel Height	8 <sup>5</sup> / <sub>16</sub> " (211)
Backer Panel Height	8 <sup>15</sup> / <sub>16</sub> " (227)

<b>11" (279) Grille (standard)</b>	<b>H</b>
Overlay Panel Height	10 <sup>1</sup> / <sub>4</sub> " (260)
Spacer Panel Height	9 <sup>5</sup> / <sub>16</sub> " (237)
Backer Panel Height	9 <sup>15</sup> / <sub>16</sub> " (252)

<b>12" (305) Grille Height</b>	<b>H</b>
Overlay Panel Height	11 <sup>1</sup> / <sub>4</sub> " (286)
Spacer Panel Height	10 <sup>5</sup> / <sub>16</sub> " (262)
Backer Panel Height	10 <sup>15</sup> / <sub>16</sub> " (278)

<b>13" (330) Grille</b>	<b>H</b>
Overlay Panel Height	12 <sup>1</sup> / <sub>4</sub> " (311)
Spacer Panel Height	11 <sup>5</sup> / <sub>16</sub> " (287)
Backer Panel Height	11 <sup>15</sup> / <sub>16</sub> " (303)

<b>14" (356) Grille</b>	<b>H</b>
Overlay Panel Height	13 <sup>1</sup> / <sub>4</sub> " (337)
Spacer Panel Height	12 <sup>5</sup> / <sub>16</sub> " (313)
Backer Panel Height	12 <sup>15</sup> / <sub>16</sub> " (329)

<b>15" (381) Grille</b>	<b>H</b>
Overlay Panel Height	14 <sup>1</sup> / <sub>4</sub> " (362)
Spacer Panel Height	13 <sup>5</sup> / <sub>16</sub> " (338)
Backer Panel Height	13 <sup>15</sup> / <sub>16</sub> " (354)

For grille panel size, use width dimensions listed for your model and height dimensions for grille option. 11" (279) grille is standard.

Panel grille is available for all overlay units except Models 601R, 601RG and 601F.

**OVERLAY PANELS**

Panel specifications are for Built-In overlay (O) models.

To install overlay panels, see the detailed procedures outlined in the Sub-Zero Built-In Installation Guide.

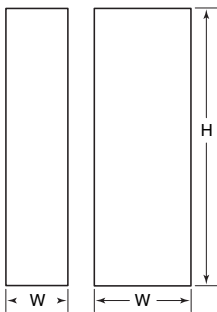

**Models 661, 642 and 632**

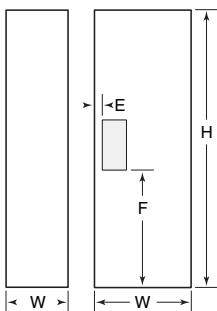

**Models 685 and 695**

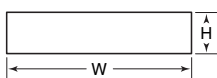

**Overlay grille panel**



BUILT-IN

# PANEL AND HANDLE PROFILE – FRAMED APPLICATION

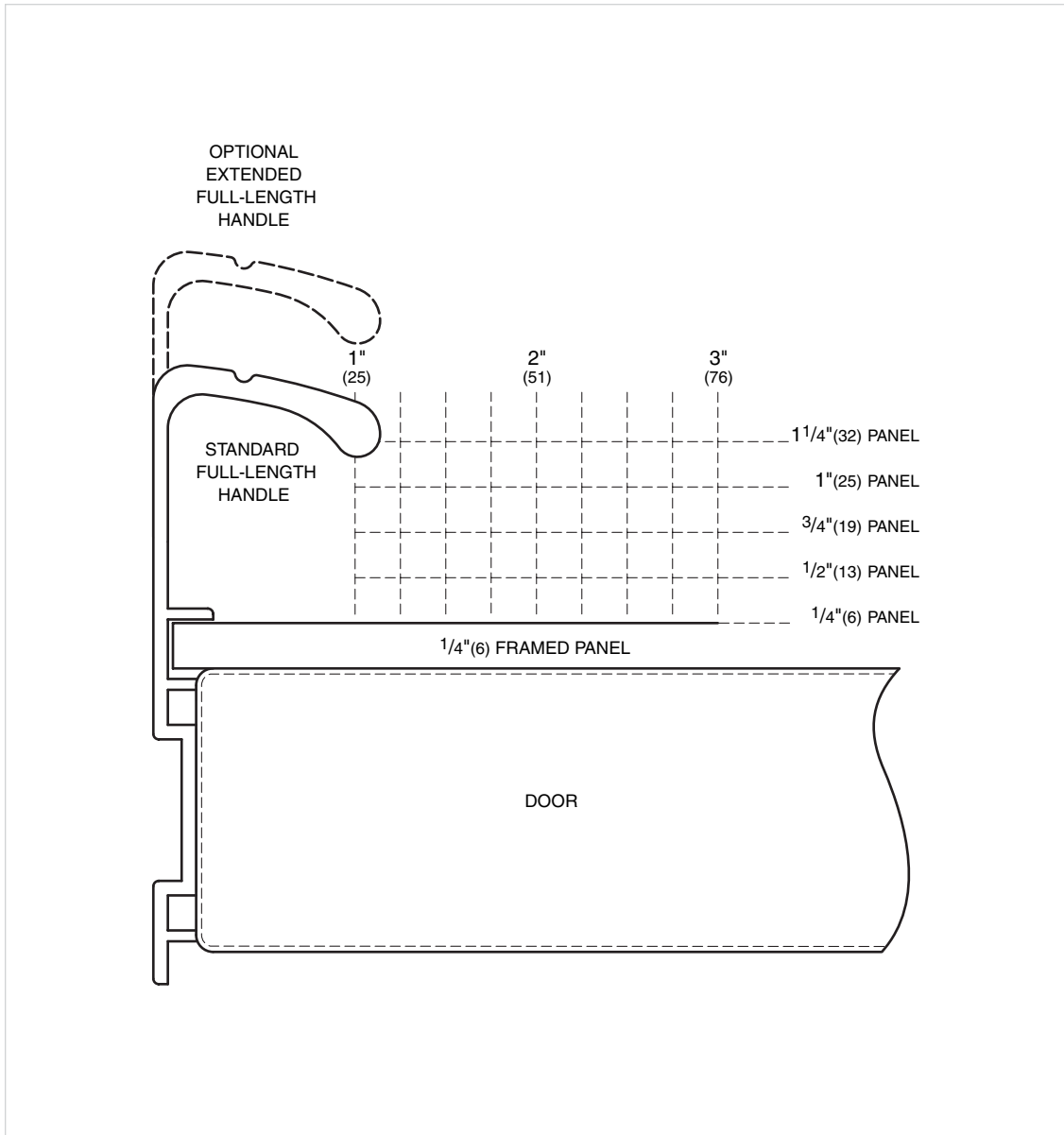

## FULL-SCALE TEMPLATES

The full-scale illustrations on the following pages enable you to understand some of the unique situations you may face as you plan for the installation of the Built-In models. Use these illustrations as templates for panel and handle hardware considerations.

The full-scale illustration above shows handle placement for the framed application standard full-length handle and the optional extended full-length handle shown in the dashed line.

*Dimensions in parentheses are in millimeters unless otherwise specified.*

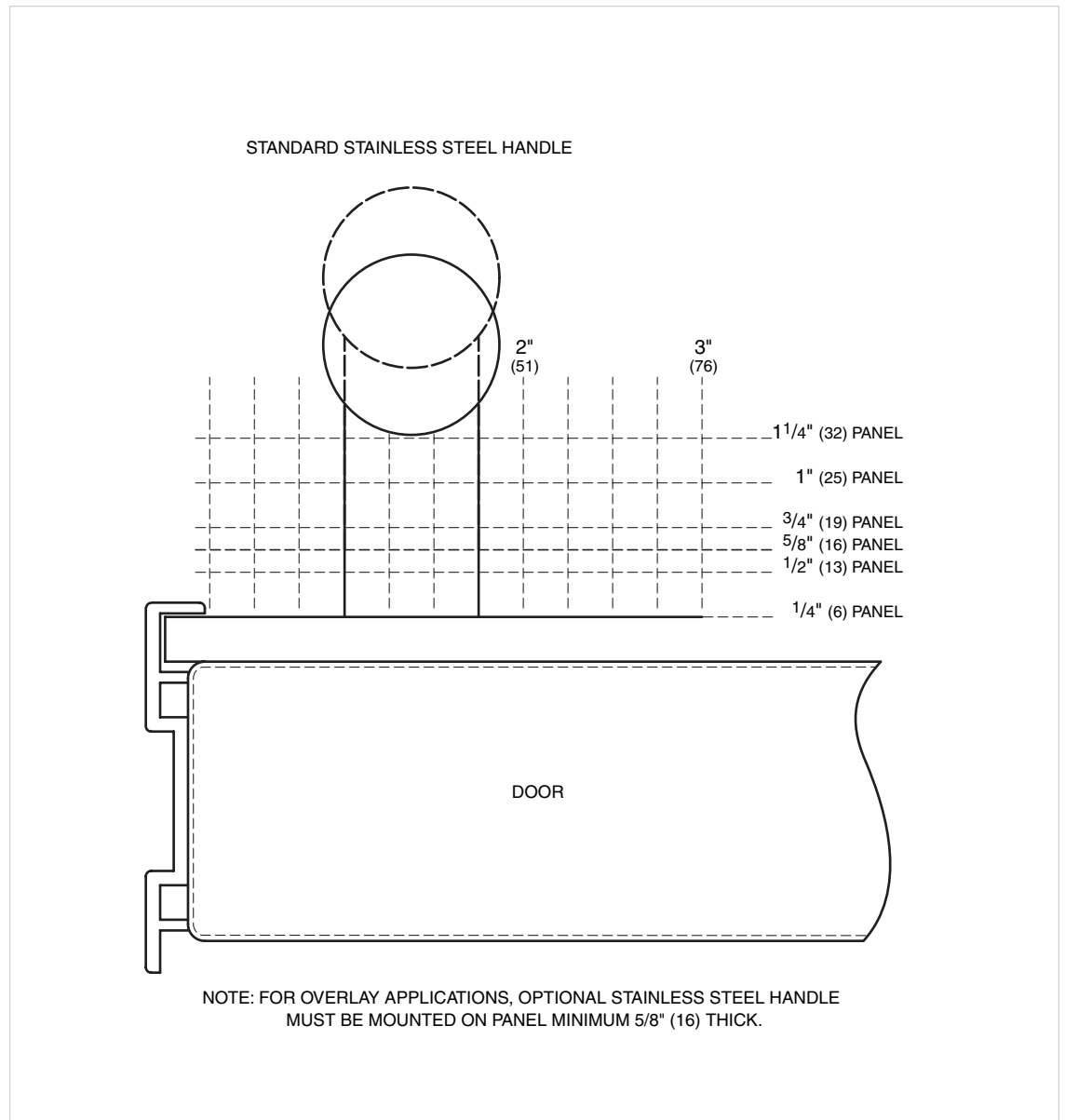

The full-scale illustration above shows handle placement for the standard stainless steel handle on the wrapped stainless steel door and on overlay panel applications shown in the dashed line.

**IMPORTANT NOTE:** For overlay applications, the panel must be a minimum of 5/8" (16) thick to support mounting the handle hardware.

For overlay applications, mount door handles close to the opening edge of the door for ease of opening.



BUILT-IN

### PANEL AND HANDLE PROFILE - 130° DOOR OPENING

The full-scale illustration shows the panel and handle profile for 130° door opening with a 2" (51) filler strip.

Interference of door panels with handles at maximum door swing may require the use of an optional 90° door stop available through your Sub-Zero dealer.

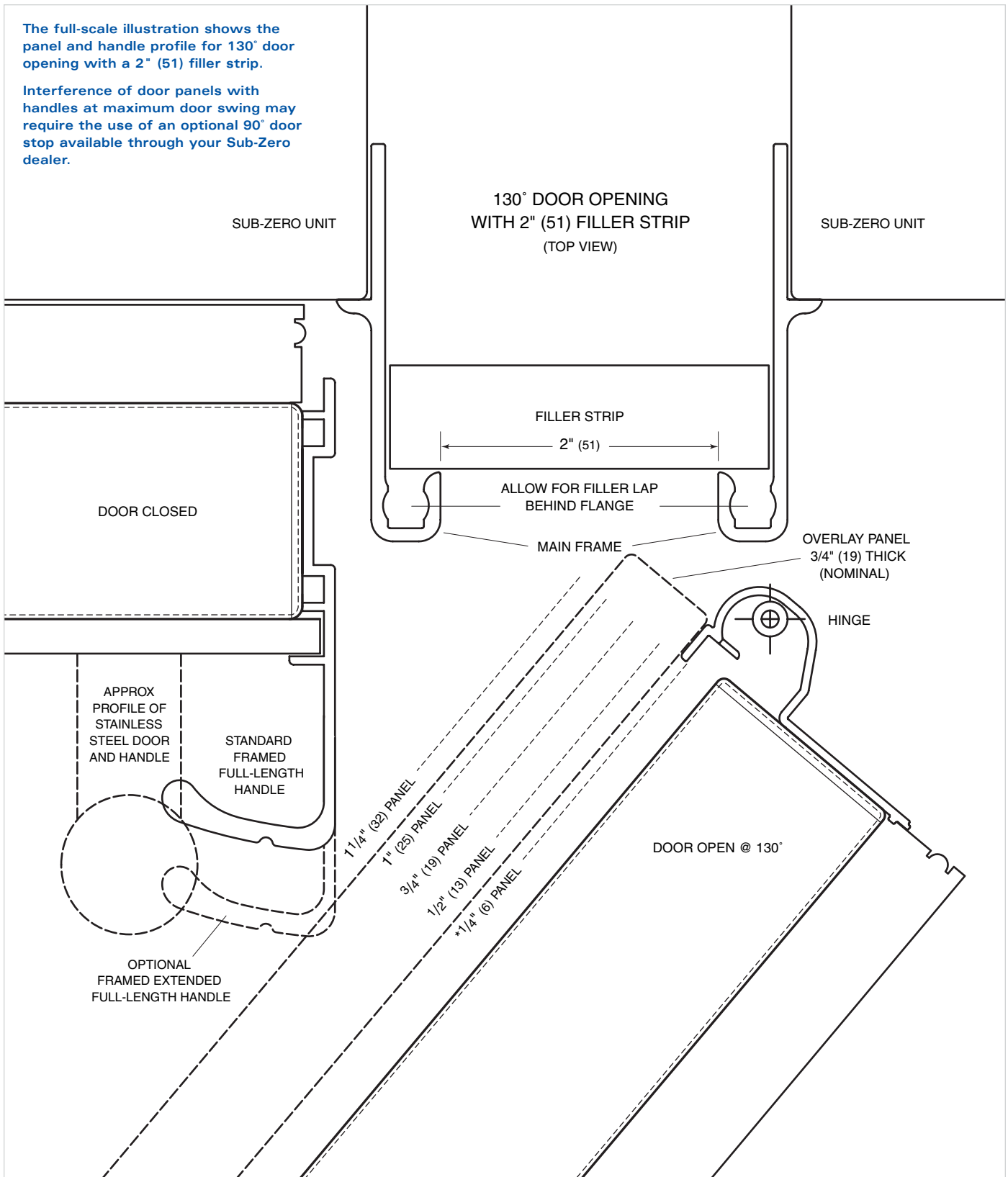

\*Approximate thickness of wrapped stainless steel door.

Dimensions in parentheses are in millimeters unless otherwise specified.



BUILT-IN

### OVERLAY PANEL APPLICATION - 90° DOOR OPENING (TOP VIEW)

The full-scale illustration shows what considerations you need to make for overlay panel applications and how they may interact with adjacent cabinets and countertops.

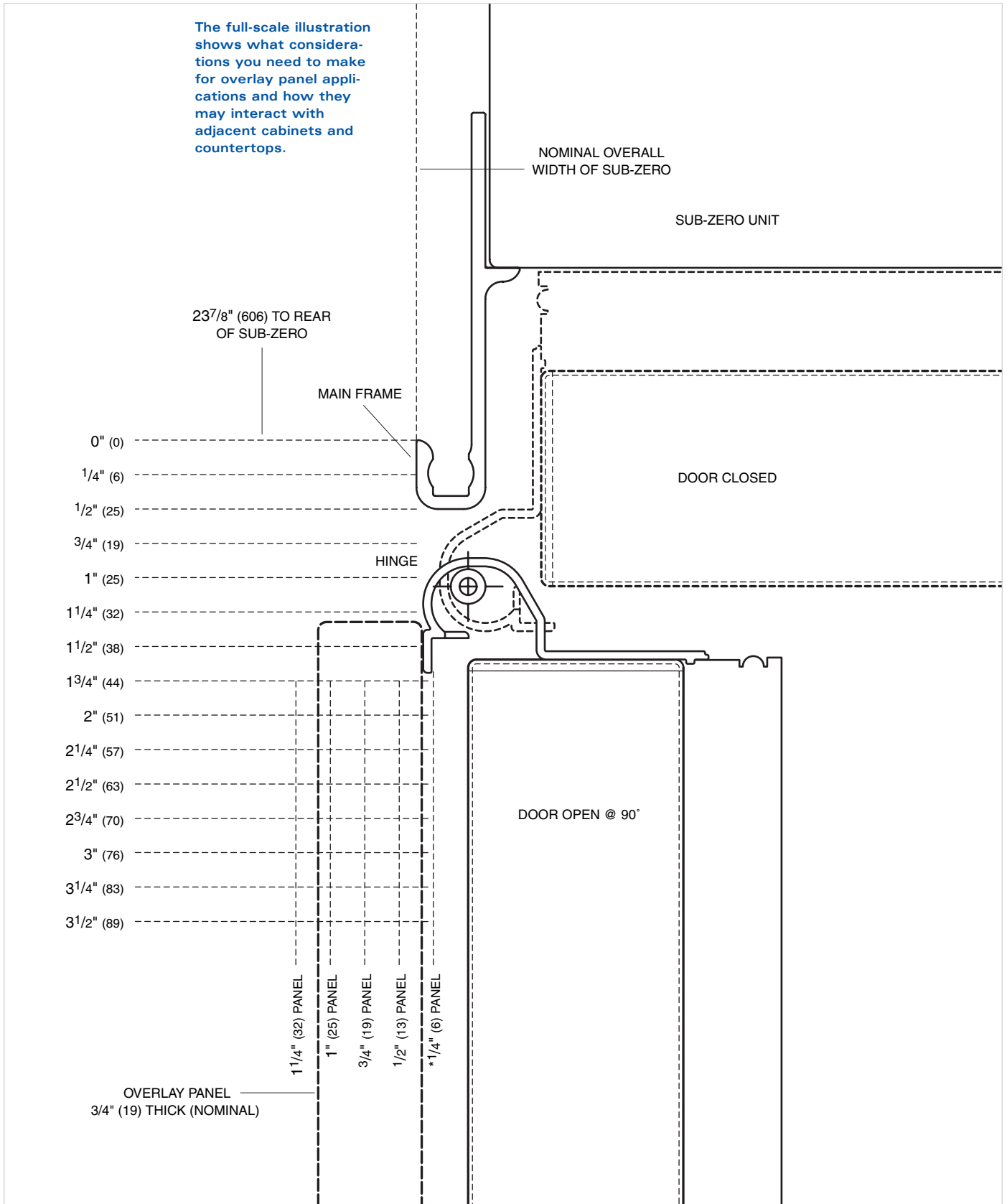

\*Approximate thickness of wrapped stainless steel door.



INTEGRATED

## INTEGRATED REFRIGERATION

For generations, the Sub-Zero name has been synonymous with built-in refrigeration. With the Integrated line, we've taken the idea a step further—refrigerators and freezers you can hide anywhere in the house, inside the furniture or cabinetry of your choosing.

Created to blend invisibly into your home's decor, the Integrated line lets you integrate refrigeration into the kitchen, master suite, media room or workout room. Available as tall units or two-drawer base units, the Integrated line expands the possibilities for the way you shape your home.

Tall units are 80" (2032) high and offered in two different widths—27" (686) and 36" (914). The 27" (686) wide tall unit can be ordered as an all refrigerator, all freezer or combination refrigerator (upper cabinet) and freezer (drawers). Model 736TC(I), the 36" (914) wide tall unit, is offered as a combination unit only. All of these models are 24" (610) deep.

Base units are offered in the 27" (686) width only. They can be ordered as an all refrigerator, all freezer or combination refrigerator (top drawer) and freezer (bottom drawer). Base units are 34 1/2" (876) high and 24" (610) deep.

You just need to add whatever beautiful cabinetry you want to use. Optional stainless steel panels with tubular handles are offered in the classic, platinum and carbon stainless steel finishes and are ordered and shipped as sales accessories. There are some size limitations on the premium finishes of platinum and carbon stainless steel.

For information regarding specific Integrated models, refer to the illustrations in this section.

## ALL REFRIGERATOR | ALL FREEZER

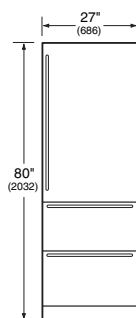

**MODEL 700TR**  
All Refrigerator

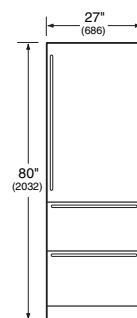

**MODEL 700TF(I)**  
All Freezer

## OVER-AND-UNDER

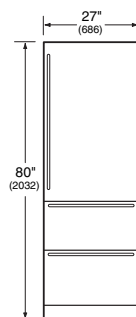

**MODEL 700TC(I)**  
Refrigerator | Freezer

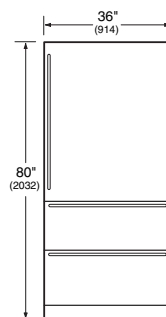

**MODEL 736TC(I)**  
Refrigerator | Freezer

## DRAWERS

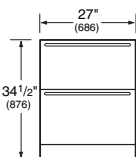

**MODEL 700BR**  
All Refrigerator  
Energy Star  
Qualified

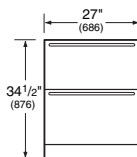

**MODEL 700BF(I)**  
All Freezer

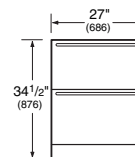

**MODEL 700BC(I)**  
Refrigerator | Freezer

Comprehensive installation instructions are shipped with each model. Refer to those instructions in preparing and installing all Sub-Zero products; call Sub-Zero Freezer Company at 800-222-7820; or check our website at [subzero.com](http://subzero.com).



With the installation of a harness kit, these appliances will be Star-K compliant mid-summer 2005 to meet strict religious regulations in conjunction with specific instructions found on [www.star-k.org](http://www.star-k.org). Model 700BC(I) is Star-K certified from the factory with no extra wiring harness required. For details about the harness kit, contact your Sub-Zero dealer.

Dimensions in parentheses are in millimeters unless otherwise specified.



INTEGRATED

### MODEL 700TR

ALL REFRIGERATOR

### MODEL 700TF

ALL FREEZER

#### ACCESSORIES

Optional accessories are available through your Sub-Zero dealer, or call Sub-Zero at 800-222-7820. You can also visit our website at [subzero.com](http://subzero.com) and click on the accessories section for your specific model.

#### SPECIFICATIONS

Overall Width	27" (686)
Overall Height	80" (2032)
Overall Depth	24" (610)
Refrigerator Capacity	15.5 cu ft (439 L)
Min Height Required	79 1/2" (2019)
Door Swing Clearance	25 1/2" (648)
Specify Door Swing	LH or RH
Drawer Clearance	19 1/2" (495)
Annual Energy Usage	425 kWh   \$36*
Shipping Weight	360 lbs (163 kg)

#### MODEL OPTIONS

Automatic Ice Maker **700TFI**

#### SPECIFICATIONS

Overall Width	27" (686)
Overall Height	80" (2032)
Overall Depth	24" (610)
Freezer Capacity	15.3 cu ft (433 L)
Min Height Required	79 1/2" (2019)
Door Swing Clearance	25 1/2" (648)
Specify Door Swing	LH or RH
Drawer Clearance	19 1/2" (495)
Annual Energy Usage	652 kWh   \$55*
Shipping Weight	360 lbs (163 kg)

#### REFRIGERATOR FEATURES

- Dual Refrigeration
- 2 Temperature Zones
- 3 Adjustable Glass Shelves
- 1 Stationary Shelf
- 2 Storage Drawers
- Removable Crisper Cover
- 2 Removable Drawer Dividers
- Adjustable Deli Drawer
- 3 Adjustable Door Shelves
- Adjustable Dairy Compartment
- Egg Container

#### FREEZER FEATURES

- 1 Temperature Zone
- 3 Adjustable Glass Shelves
- 1 Stationary Shelf
- 2 Storage Drawers
- 2 Removable Drawer Dividers (700TF)
- 1 Removable Drawer Divider (700TFI)
- 4 Adjustable Door Shelves
- Automatic Defrost
- Automatic Ice Maker **Model 700TFI**

#### PANEL OPTIONS

Integrated  
Classic, platinum or carbon stainless steel finish (includes handles)\*\*

#### PANEL OPTIONS

Integrated  
Classic, platinum or carbon stainless steel finish (includes handles)\*\*

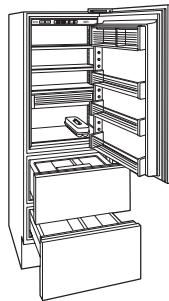

MODEL 700TR

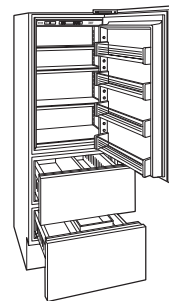

MODEL 700TF(I)



INTEGRATED

## MODEL 700TC

OVER-AND-UNDER

### MODEL OPTIONS

Automatic Ice Maker **700TCI**

### SPECIFICATIONS

Overall Width **27" (686)**  
 Overall Height **80" (2032)**  
 Overall Depth **24" (610)**  
 Refrigerator Capacity **10.2 cu ft (289 L)**  
 Freezer Capacity **5.1 cu ft (144 L)**  
 Min Height Required **79<sup>1</sup>/<sub>2</sub>" (2019)**  
 Door Swing Clearance **25<sup>1</sup>/<sub>2</sub>" (648)**  
 Specify Door Swing **LH or RH**  
 Drawer Clearance **19<sup>1</sup>/<sub>2</sub>" (495)**  
 Annual Energy Usage **540 kWh | \$45\***  
 Shipping Weight **360 lbs (163 kg)**

### REFRIGERATOR (DOOR)

Dual Refrigeration  
**3** Adjustable Glass Shelves  
**1** Stationary Shelf  
 Adjustable Deli Drawer  
**3** Adjustable Door Shelves  
 Adjustable Dairy Compartment  
 Egg Container

### FREEZER (DRAWERS)

**2** Removable Drawer Dividers (700TC)  
**1** Removable Drawer Divider (700TCI)  
 Automatic Defrost  
 Automatic Ice Maker (700TCI)

### PANEL OPTIONS

Integrated  
 Classic, platinum or carbon stainless steel finish (includes handles)\*\*

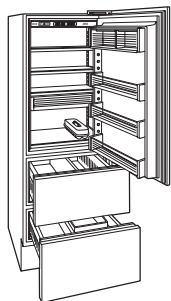

MODEL 700TC(I)

## MODEL 736TC

OVER-AND-UNDER

### MODEL OPTIONS

Automatic Ice Maker **736TCI**

### SPECIFICATIONS

Overall Width **36" (914)**  
 Overall Height **80" (2032)**  
 Overall Depth **24" (610)**  
 Refrigerator Capacity **13.5 cu ft (383 L)**  
 Freezer Capacity **6.9 cu ft (195 L)**  
 Min Height Required **79<sup>1</sup>/<sub>2</sub>" (2019)**  
 Door Swing Clearance **34<sup>1</sup>/<sub>2</sub>" (876)**  
 Specify Door Swing **LH or RH**  
 Drawer Clearance **19<sup>1</sup>/<sub>2</sub>" (495)**  
 Annual Energy Usage **569 kWh | \$48\***  
 Shipping Weight **480 lbs (218 kg)**

### REFRIGERATOR (DOOR)

Dual Refrigeration  
**2** Temperature Zones  
**3** Adjustable Glass Shelves  
**1** Stationary Shelf  
 Adjustable Deli Drawer  
**3** Adjustable Door Shelves  
 Adjustable Dairy Compartment  
 Egg Container

### FREEZER (DRAWERS)

**2** Removable Drawer Dividers (736TC)  
**1** Removable Drawer Divider (736TCI)  
 Automatic Defrost  
 Automatic Ice Maker (736TCI)

### PANEL OPTIONS

Integrated  
 Classic, platinum or carbon stainless steel finish (includes handles)\*\*

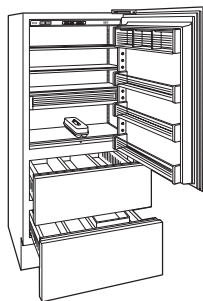

MODEL 736TC(I)

*\*Annual energy costs are based on 8.29 cents per kilowatt hour.*

*\*\*Optional stainless steel panels and handles are ordered and shipped as sales accessories. For additional information on panel and handle sizes and applications, go to [subzero.com](http://subzero.com) and review the accessories section under each model for specifics.*

### ACCESSORIES

Contact your Sub-Zero Dealer

Classic stainless steel front panels—platinum and carbon available in certain sizes

Tubular handles in classic, platinum and carbon stainless steel

Shelf and high humidity crisper drawer assembly\*

Crisper cover with lid\*

Dozen egg container with lid\*

Dual installation heater kit

*\*Accessory is not available for every model.*

*Dimensions in parentheses are in millimeters unless otherwise specified.*



INTEGRATED

### MODEL 700BR

REFRIGERATOR DRAWERS

*Energy Star Qualified*

#### SPECIFICATIONS

Overall Width	<b>27" (686)</b>
Overall Height	<b>34 1/2" (876)</b>
Overall Depth	<b>24" (610)</b>
Refrigerator Capacity	<b>5.3 cu ft (150 L)</b>
Min Height Required	<b>34" (864)</b>
Drawer Clearance	<b>19 1/2" (495)</b>
Annual Energy Usage	<b>337 kWh   \$28*</b>
Shipping Weight	<b>190 lbs (86 kg)</b>

#### REFRIGERATOR FEATURES

- 1 Temperature Zone
- 2 Storage Drawers
- Removable Crisper Cover
- 2 Removable Drawer Dividers

#### PANEL OPTIONS

Integrated  
Classic, platinum or carbon stainless steel finish (includes handles)\*\*

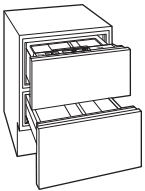

MODEL 700BR

### MODEL 700BF

FREEZER DRAWERS

#### MODEL OPTIONS

Automatic Ice Maker **700BFI**

#### SPECIFICATIONS

Overall Width	<b>27" (686)</b>
Overall Height	<b>34 1/2" (876)</b>
Overall Depth	<b>24" (610)</b>
Freezer Capacity	<b>5.1 cu ft (144 L)</b>
Min Height Required	<b>34" (864)</b>
Drawer Clearance	<b>19 1/2" (495)</b>
Annual Energy Usage	<b>488 kWh   \$41*</b>
Shipping Weight	<b>190 lbs (86 kg)</b>

#### FREEZER FEATURES

- 1 Temperature Zone
- 2 Storage Drawers
- 2 Removable Drawer Dividers (700BF)
- 1 Removable Drawer Divider (700BFI)
- Automatic Defrost
- Automatic Ice Maker (700BFI)

#### PANEL OPTIONS

Integrated  
Classic, platinum or carbon stainless steel finish (includes handles)\*\*

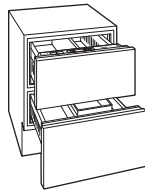

MODEL 700BF(I)

### MODEL 700BC

REFRIGERATOR | FREEZER DRAWERS

#### MODEL OPTIONS

Automatic Ice Maker **700BCI**

#### SPECIFICATIONS

Overall Width	<b>27" (686)</b>
Overall Height	<b>34 1/2" (876)</b>
Overall Depth	<b>24" (610)</b>
Refrigerator Capacity	<b>2.9 cu ft (82 L)</b>
Freezer Capacity	<b>2.1 cu ft (59 L)</b>
Min Height Required	<b>34" (864)</b>
Drawer Clearance	<b>19 1/2" (495)</b>
Annual Energy Usage	<b>448 kWh   \$38*</b>
Shipping Weight	<b>190 lbs (86 kg)</b>

#### FEATURES

- 2 Temperature Zones
- 2 Storage Drawers
- Removable Crisper Cover
- 1 Removable Drawer Divider (700BC)
- Automatic Ice Maker (700BCI)

#### PANEL OPTIONS

Integrated  
Classic, platinum or carbon stainless steel finish (includes handles)\*\*

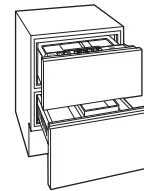

MODEL 700BC(I)

#### ACCESSORIES

Contact your Sub-Zero Dealer

**Front panels in classic, platinum and carbon stainless steel**

**Tubular handles in classic, platinum and carbon stainless steel**

**Crisper cover with lid\***

**Dozen egg container with lid\***

**Dual installation heater kit**

*\*Accessory is not available for every model.*

*Dimensions in parentheses are in millimeters unless otherwise specified.*

*\*Annual energy costs are based on 8.29 cents per kilowatt hour.*

*\*\*Optional stainless steel panels and handles are ordered and shipped as sales accessories. For additional information on panel and handle sizes and applications, go to [subzero.com](http://subzero.com) and review the accessories section under each model for specifics.*



INTEGRATED

## INTEGRATED FEATURES

All Integrated models accept wood or stainless steel panels. The optional stainless steel panels and handles are available in classic, platinum and carbon stainless steel finishes at the 80" (2032) height, and only classic stainless steel at the 84" (2134) height. Stainless steel panels are ordered and shipped as sales accessories.

**Functional Design.** These models can be placed anywhere in the home. Think about "point-of-use refrigeration" when planning where to place your units.

**Integrated Design.** All Sub-Zero models are 24" (610) deep. Tall Integrated units are 80" (2032) high and are offered in two different widths—27" (686) and 36" (914). All base units are 27" (686) wide and 34<sup>1</sup>/<sub>2</sub>" (876) high.

**Microprocessor.** The "brains" of the Integrated units, this computer allows the best in temperature control, efficiency and food preservation.

**Temperature Zones.** On the tall refrigerator and all combination units, you have the flexibility of having two temperatures within the same unit.

**Automatic Defrost.** Depending on usage and exact climate, the Integrated unit will adapt to the unique situation and adjust accordingly to offer greater efficiency. Integrated freezer and combination units have an automatic defrost system.

**Kickplate.** The adjustable solid kickplate meets standards of the American Institute of Architects. The toe kick area for a solid, decorative kickplate is 4" (102) high by 3" (76) deep. You can show a 10" (254) toe kick, but you cannot cover the louvers of the kickplate. If you choose, the kickplate can be painted.

**Front Venting.** All models have the mechanical equipment in an area below the lower drawer. The lower drawer panel can extend to cover these louvers, but a removable decorative kickplate cannot cover the fins.

**Lighting.** Flat to the ceiling, superior lighting provides white, efficient light in cabinet and drawer units.

**Door/Drawer Alarm.** When activated, if your door or drawer is accidentally left open for more than 30 seconds, an audible alarm will sound.

**Spill-Proof Shelves.** The cabinet section of the tall units features adjustable spill-proof one-piece glass shelves that are easily removed for cleaning.

**Dairy Shelf.** This magnetically sealed compartment is fully adjustable on the tall refrigerator and combination units.

**Crisper Cover.** On the tall and base refrigerator units and the base combination unit, a removable crisper cover is offered for one of the drawer sections.

**Deli Drawer.** Smaller items are not lost in this handy feature of the tall refrigerator and tall combination units.

**Egg Container.** You can store a dozen eggs in this removable egg container with lid in the tall refrigerator and tall combination units.

**Ice Maker.** An automatic ice maker, providing crescent-shaped ice, is available as an option on the tall and base freezers as well as the tall and base combination units. This optional equipment must be factory installed.

**Door Swing.** You can choose left or right door swing on the tall units. This option must be ordered when requesting the unit. You cannot reverse the door in the field.

**Dual-Action Hinge.** An exclusive dual-action hinge is featured on all of the tall units.

**Door Stop.** On all of the tall units, a 90° door stop is built in to the hinge. Normal door swing is 105°.

**Temperature Zones.** With the microprocessor in the Integrated models, you have the capability of setting different optimum temperatures.

SUB-ZERO  
WARRANTY

Sub-Zero products are covered by a two, five and twelve year residential warranty (exclusions apply). See warranty details at the end of this guide.

ACCESSORIES

Optional accessories are available through your Sub-Zero dealer, or call Sub-Zero at 800-222-7820. You can also visit our website at [subzero.com](http://subzero.com) and click on the accessories section for your specific model.

## TEMPERATURE ZONES

Model 700BR - One zone,  
34°F (1°C) to 45°F (7°C)

Model 700TR - Two zones,  
34°F (1°C) to 45°F (7°C)

Model 700BF(I) - One zone,  
-5°F (-21°C) to +5°F (-15°C)

Model 700TF(I) - One zone,  
-5°F (-21°C) to +5°F (-15°C)

Model 700BC(I) - Two zones,  
34°F (1°C) to 45°F (7°C) top drawer;  
-5°F (-21°C) to +5°F (-15°C) bottom  
drawer

Model 700TC(I) - Two zones,  
34°F (1°C) to 45°F (7°C) cabinet;  
-5°F (-21°C) to +5°F (-15°C) drawers

Model 736TC(I) - Two zones,  
34°F (1°C) to 45°F (7°C) cabinet;  
-5°F (-21°C) to +5°F (-15°C) drawers



INTEGRATED

## PLANNING INFORMATION

Before moving the Integrated unit into place, be sure that the finished opening dimensions, electrical and plumbing locations and minimum door and drawer clearances are accurate. Refer to the Installation Specifications illustration for your model on the following pages. Be sure your installer has this information before finishing work is completed.

## INSTALLATION

Refer to the installation instructions shipped with each Sub-Zero product for detailed specifications.

Integrated models without an automatic ice maker will not require the plumbing connections shown in the illustrations.

The height of the tall unit is set at 80" (2032). You can allow the top of the door panel to exceed this dimension with caution. If you are working with 84" (2134) or 96" (2438) neighboring panels, you can utilize door panels to match this height. Other critical dimensions regarding the door swing, drawer openings and toe kick clearance are noted in the Overall Dimensions illustrations on the following pages. Also refer to the full-scale illustrations at the end of this section for specifics on door openings and other specifications.

**IMPORTANT NOTE:** The anti-tip bracket must be installed to prevent the unit from tipping forward.

## ELECTRICAL REQUIREMENTS

A 115 V AC, 60 Hz, 15 amp circuit breaker and electrical supply are required. A separate circuit, servicing each base and tall unit, is required.

All Sub-Zero Integrated models are equipped with a power supply cord with a 3-prong grounding plug, which must be plugged into a mating 3-prong grounding-type wall receptacle. Follow the National Electrical Code and local codes and ordinances when installing the receptacle.

**IMPORTANT NOTE:** The electrical outlet must be placed so the grounding prong is to the right of the thinner blades. The outlet must be flush with the back wall. Refer to the Installation Specifications illustration for your model for exact placement.

**IMPORTANT NOTE:** A ground fault circuit interrupter (GFCI) is not recommended and may cause interruption of operation.

## ⚠ WARNING

Do not use an extension cord or 2-prong adapter. Electrical ground is required.

Do not under any circumstances remove the power supply cord ground prong.

## PLUMBING CONSIDERATIONS

For models with an automatic ice maker, rough in the water supply line. Connect a 1/4" OD copper line to the house supply, being sure to use an easily accessible shut-off valve between the supply and the unit. This shut-off valve should not be installed behind the unit.

Do not use self-piercing valves. A saddle valve kit (4200880) is available from your Sub-Zero dealer. An in-line filter is required when water conditions have a high sediment content. The ice maker operates on constant water pressure between 20 psi (1.4 bar) and 100 psi (6.9 bar).

**IMPORTANT NOTE:** In some cases, a reverse osmosis water filter system may not be able to maintain the minimum pressure consistently.

The Installation Specifications illustration for your model on the following pages shows the precise placement of the water line. When routing the water through the side walls, you must place the water line within 1/2" (13) of the floor and as close as possible to the back wall. The line must be routed around the anti-tip bracket so it clears the bracket and the leveling feet of the unit as shown in the top view of the illustration. Regardless of the routing, allow for 27" (686) of excess copper tubing to remain outside the wall or floor for easy connection to the unit.

**IMPORTANT NOTE:** Do not route water supply line in front of the compressor tray. The tray must be slid forward for service.

*Dimensions in parentheses are in millimeters unless otherwise specified.*



INTEGRATED

OVERALL DIMENSIONS

Models 700TR, 700TF(I) and 700TC(I)

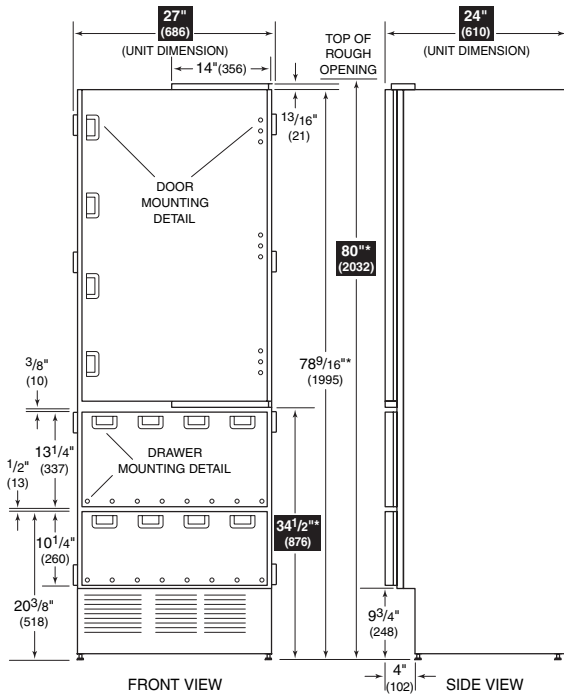

\*1/2" (13) ± ADJUSTMENT IN LEVELING LEGS

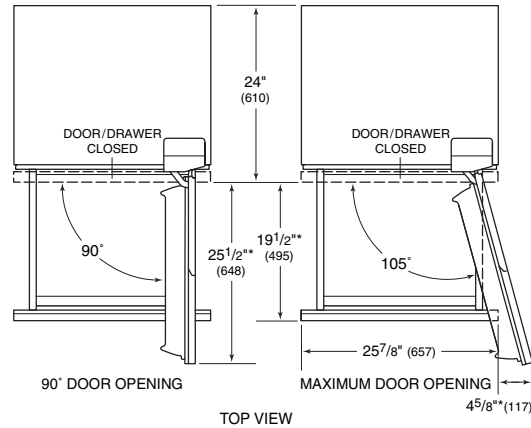

\*DOOR/DRAWER PANEL THICKNESS NOT INCLUDED - DIMENSION WILL VARY WITH INSTALLATION

ALL REFRIGERATOR  
ALL FREEZER

**Model 700TR**  
All Refrigerator

**Model 700TF**  
All Freezer

**Model 700TFI**  
All Freezer  
with Ice Maker

OVER-AND-UNDER  
Refrigerator / Freezer

**Model 700TC**

**Model 700TCI**  
with Ice Maker

INSTALLATION  
SPECIFICATIONS

Models 700TR, 700TF(I) and 700TC(I)

Models without an ice maker will not require the water line connection.

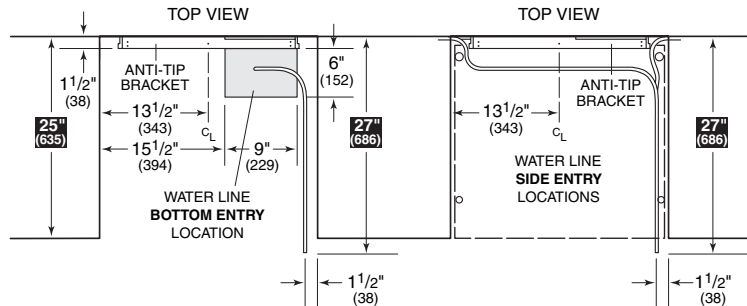

MODEL 700TR  
MODEL 700TF(I)  
MODEL 700TC(I)

**Overall Dimensions**

Width 27" (686)  
Height 80" (2032)  
Depth 24" (610)

**Finished Opening**

Width 27" (686)  
Height 80" (2032)  
Depth 25" (635)\*

\*The depth of the unit is 24" (610) from the front of the unit to its back. Your design may necessitate moving the unit back or cabinets forward to achieve a flush fit. This will require a minimum rough opening depth of 25" (635).

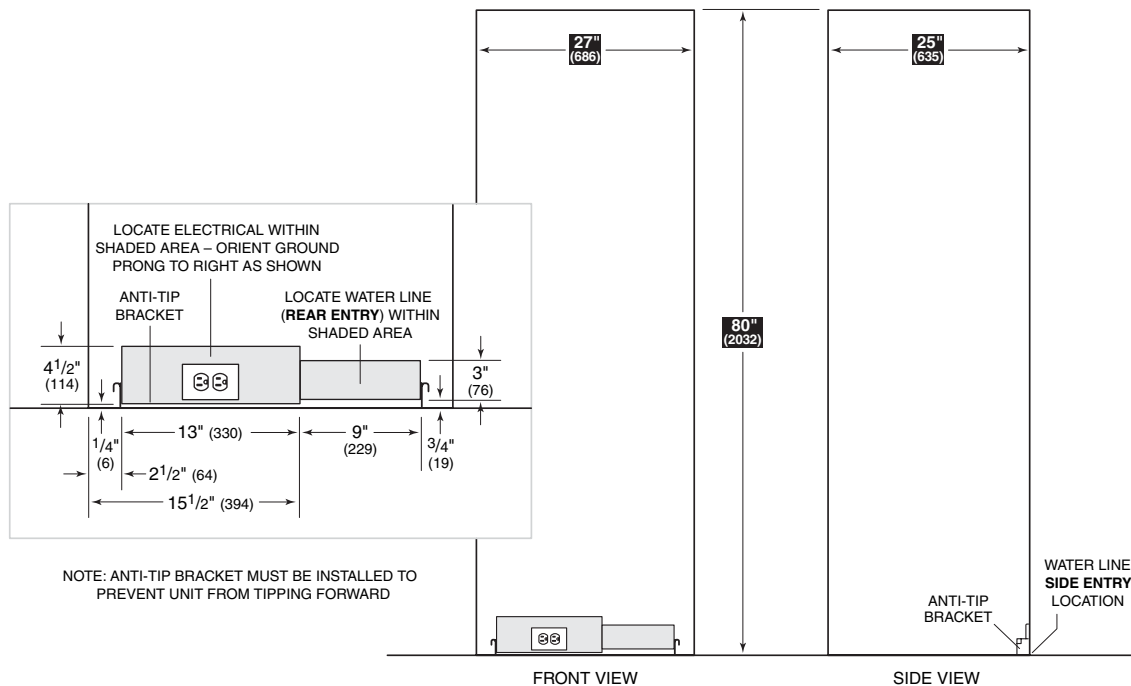

NOTE: ANTI-TIP BRACKET MUST BE INSTALLED TO PREVENT UNIT FROM TIPPING FORWARD

FRONT VIEW

SIDE VIEW



INTEGRATED

OVERALL DIMENSIONS  
Model 736TC(I)

OVER-AND-UNDER  
Refrigerator / Freezer

Model 736TC  
Model 736TCI  
with Ice Maker

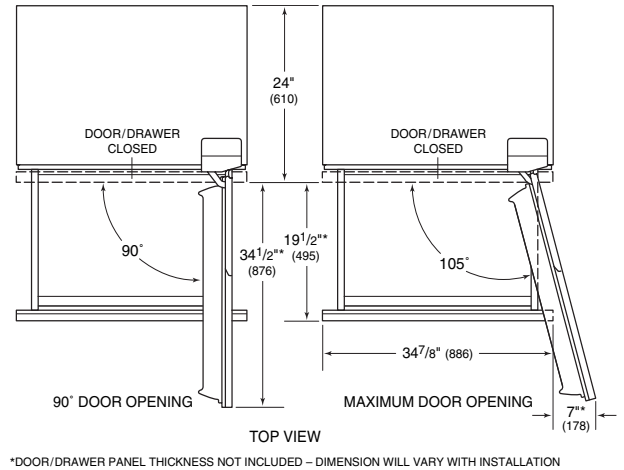
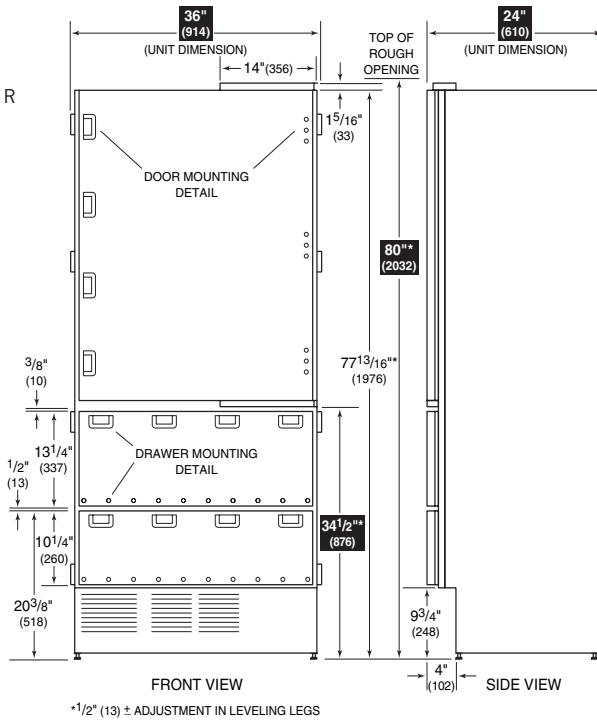

TOP VIEW  
\*DOOR/DRAWER PANEL THICKNESS NOT INCLUDED - DIMENSION WILL VARY WITH INSTALLATION

MODEL 736TC(I)

Overall Dimensions

Width 36" (914)  
Height 80" (2032)  
Depth 24" (610)

Finished Opening

Width 36" (914)  
Height 80" (2032)  
Depth 25" (635)\*

\*The depth of the unit is 24" (610) from the front of the unit to its back. Your design may necessitate moving the unit back or cabinets forward to achieve a flush fit. This will require a minimum rough opening depth of 25" (635).

INSTALLATION  
SPECIFICATIONS  
Model 736TC(I)

Model 736TC, which does not have an ice maker, will not require the water line connection.

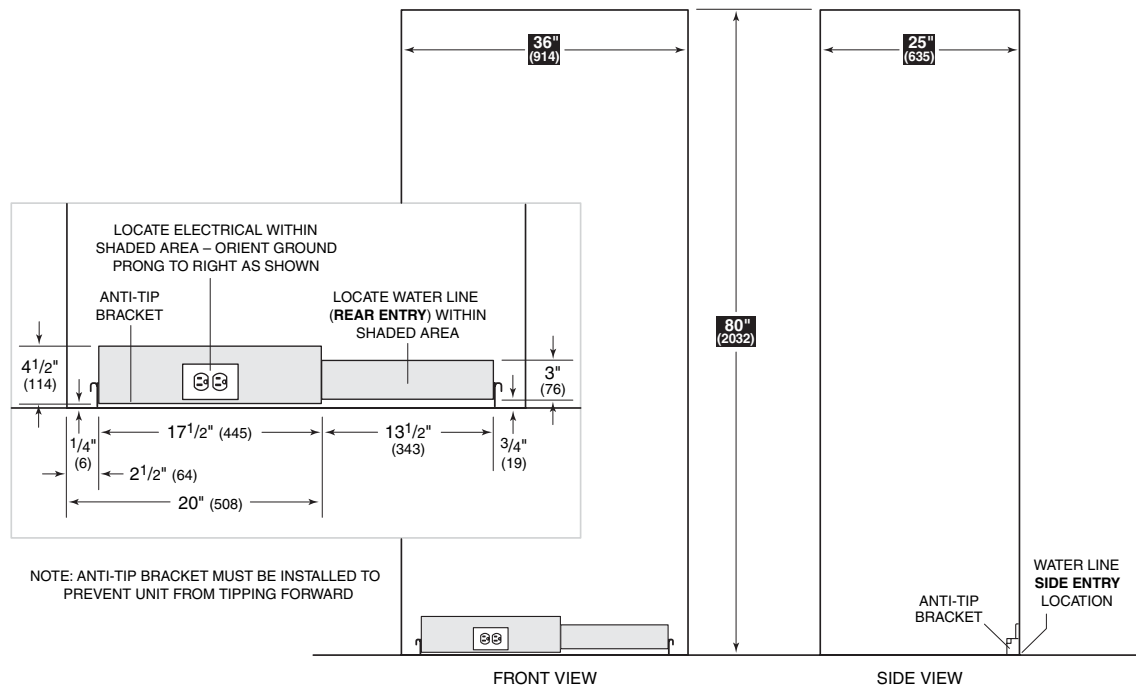
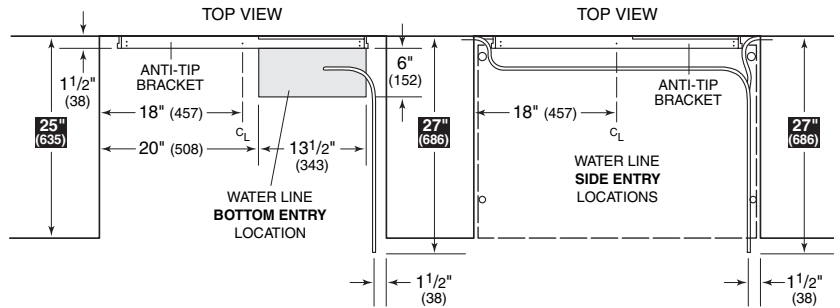



INTEGRATED

OVERALL DIMENSIONS

Models 700BR, 700BF(I) and 700BC(I)

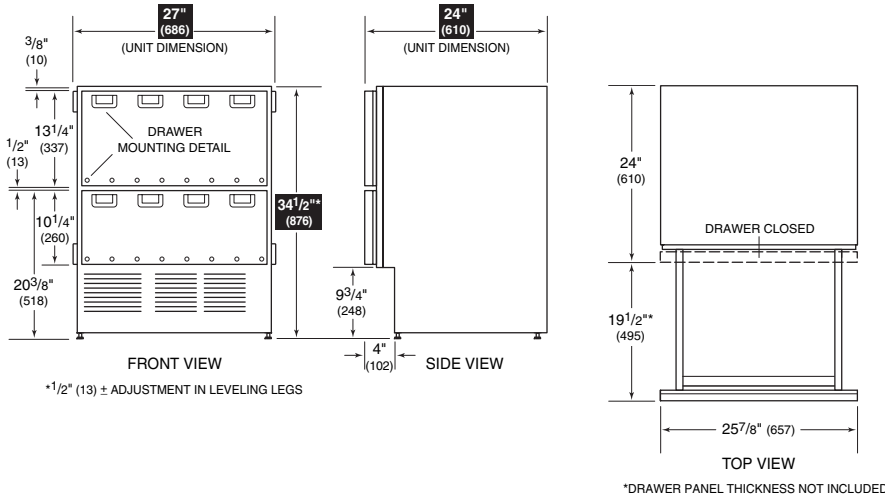

DRAWERS

**Model 700BR**  
All Refrigerator

**Model 700BF**  
All Freezer

**Model 700BF1**  
All Refrigerator  
with Ice Maker

**Model 700BC**  
Refrigerator / Freezer

**Model 700BC1**  
Refrigerator / Freezer  
with Ice Maker

INSTALLATION SPECIFICATIONS

Models 700BR, 700BF(I) and 700BC(I)

Models without an ice maker will not require the water line connection.

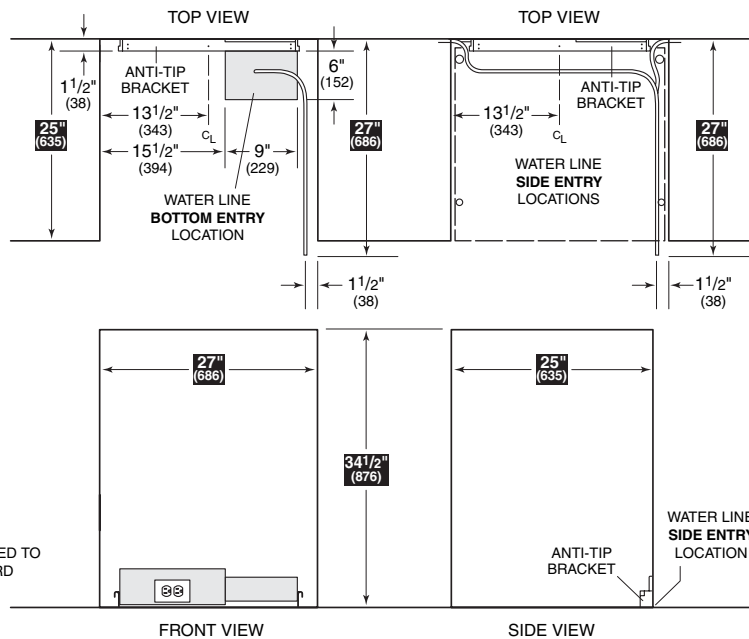

NOTE: ANTI-TIP BRACKET MUST BE INSTALLED TO PREVENT UNIT FROM TIPPING FORWARD

MODEL 700BR  
MODEL 700BF(I)  
MODEL 700BC(I)

**Overall Dimensions**  
Width 27" (686)  
Height 34 1/2" (876)  
Depth 24" (610)

**Finished Opening**  
Width 27" (686)  
Height 34 1/2" (876)  
Depth 25" (635)\*

\*The depth of the unit is 24" (610) from the front of the unit to its back. Your design may necessitate moving the unit back or cabinets forward to achieve a flush fit. This will require a minimum rough opening depth of 25" (635).

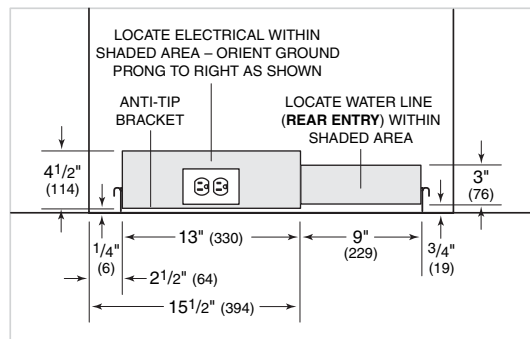

INSTALLATION

Refer to the installation instructions shipped with each Sub-Zero product for detailed specifications.

Dimensions in parentheses are in millimeters unless otherwise specified.



INTEGRATED

## CABINETY APPLICATIONS

Integrated refrigeration is compatible with virtually any style and look of cabinetry. The models can be used with framed as well as frameless cabinets. Because of the precise application and the look you may want to achieve, there are important questions you need to answer before ordering panels for the doors/drawers. As you look at styles of cabinets, keep some important facts in mind:

### PANEL REQUIREMENTS

**Door and drawer panels must be a minimum of 5/8" (16) thick.**

**The door panel cannot exceed 40 lbs (18 kg) and each drawer panel must not exceed 12 lbs (5 kg) for 27" (686) wide units. For Model 736TC(I) the door panel weight limit is 53 lbs (24 kg) and 16 lbs (7 kg) for each drawer panel.**

**IMPORTANT NOTE:** The depth of each Integrated model is 24" (610) from the front of the unit to its back. You **must** allow for the thickness of the panel you are applying when planning for the finished rough opening depth if you want the front panel to be flush with surrounding cabinetry. You **must** move the unit back into drywall or bring the cabinets forward to achieve a flush fit.

The height of the door panel can grow beyond 45<sup>1</sup>/<sub>4</sub>" (1149) and exceed the 80" (2032) overall height as long as you stay below the recommended door panel weight limit.

The toe kick clearance can vary with the height of the lower drawer panel; the maximum panel height is 16<sup>9</sup>/<sub>16</sub>" (421). You must keep a minimum space of 4" (102) clear below the bottom edge of the lower drawer panel so the unit can be properly vented.

We recommend using D-style handles. For the cabinet door, handles must be located near the edge of the panel opposite the hinge, centered top to bottom. Locate handles in the top center area of the drawer panels.

## FRAMED CABINETY

Framed cabinetry applications present you with different questions to address. The illustrations below show common applications of framed cabinetry. These are not meant to be the only alternatives, but are suggestions from designers around the country. Also refer to the full-scale illustrations at the end of this section for specifics on door openings.

**NOTE:** In the illustrations below, the first width dimension shown is for 27" (686) wide units and the second dimension is for the Model 736TC(I).

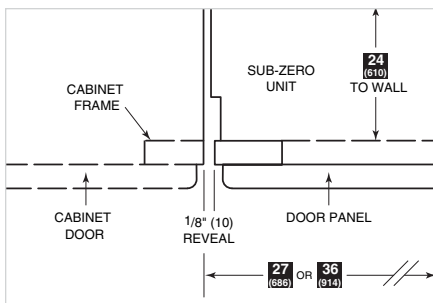

**Traditional frame - full overlay (top view)**

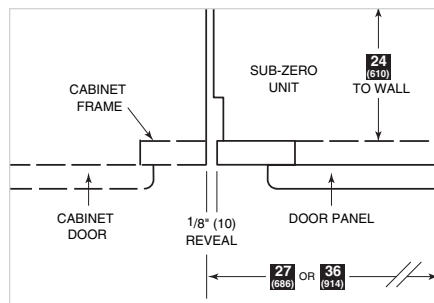

**Traditional frame - standard overlay (top view)**

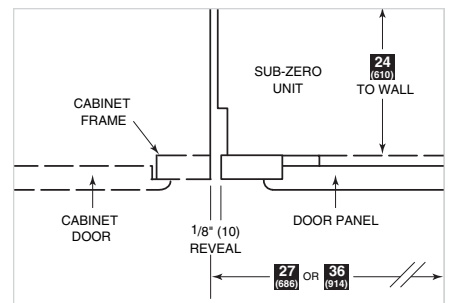

**Traditional frame - 3/8" (10) offset (top view)**



INTEGRATED

### FRAMED CABINETRY – BEADED INSET APPLICATION

The illustration below shows a 27" (686) wide Integrated base or tall unit installed within a framed cabinetry beaded inset application. Review, giving particular attention to the overall panel specifications. Also refer to the full-scale illustrations at the end of this section for specifics on door openings.

27" (686)  
WIDE MODELS

**Installation of a 27" (686) wide Integrated base or tall unit within framed cabinetry.**

*\*Dimensions may vary.*

*Dimensions are based on a 1/8" (3) reveal. A reveal of up to 1/4" (6) is possible, but panel dimensions need to be adjusted accordingly.*

#### INSTALLATION

**To install integrated panels, see the detailed procedures outlined in the Sub-Zero Integrated Installation Guide.**

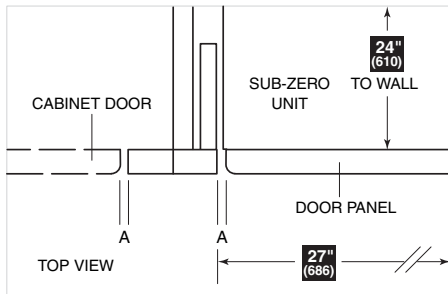

- A) ALL REVEALS ARE 1/8" (3)
- B) DRAWER RAILS ARE ATTACHED TO DRAWER FRONTS
- C) BOTTOM RAIL MUST BE REMOVABLE

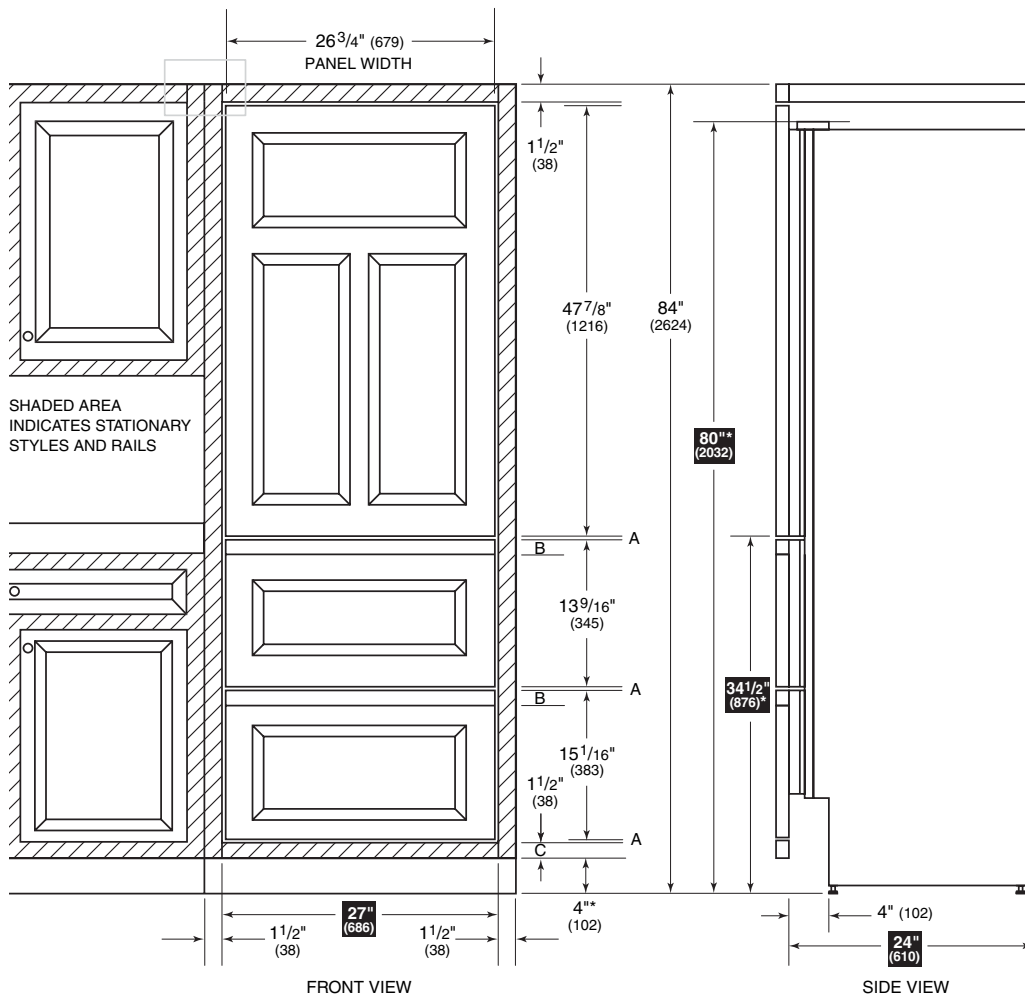

*Dimensions are in inches with millimeters in parentheses unless otherwise specified.*



INTEGRATED

## FRAMED CABINETRY – BEADED INSET APPLICATION

The illustration below shows a Model 736TC(I) installed within a framed cabinetry beaded inset application. Review, giving particular attention to the overall panel specifications. Also refer to the full-scale illustrations at the end of this section for specifics on door openings.

MODEL 736TC(I)

### Installation of the Model 736TC(I) Integrated tall unit within framed cabinetry.

*\*Dimensions may vary.*

*Dimensions are based on a 1/8" (3) reveal. A reveal of up to 1/4" (6) is possible, but panel dimensions need to be adjusted accordingly.*

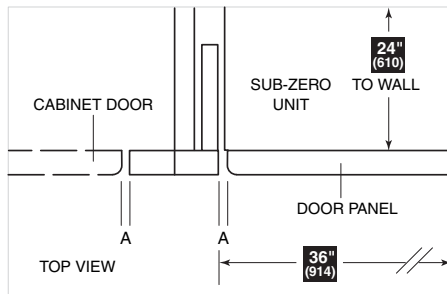

- A) ALL REVEALS ARE 1/8" (3)
- B) DRAWER RAILS ARE ATTACHED TO DRAWER FRONTS
- C) BOTTOM RAIL MUST BE REMOVABLE

### INSTALLATION

To install integrated panels, see the detailed procedures outlined in the Sub-Zero Integrated Installation Guide.

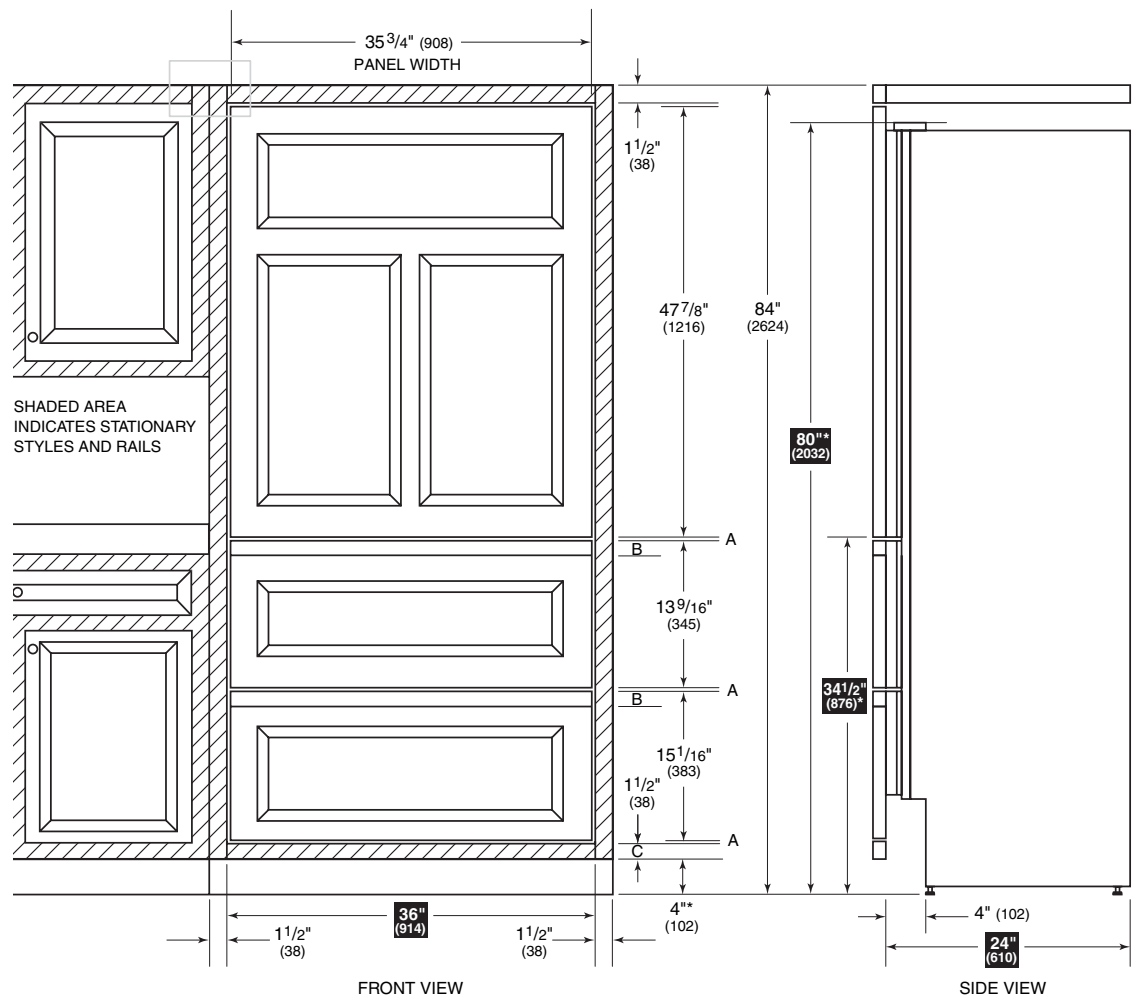



INTEGRATED

### FRAMELESS CABINETRY

The illustrations show hypothetical installations of Integrated base or tall units within frameless cabinetry. Review, giving particular attention to the overall panel specifications. Also refer to the full-scale illustrations at the end of this section for specifics on door openings.

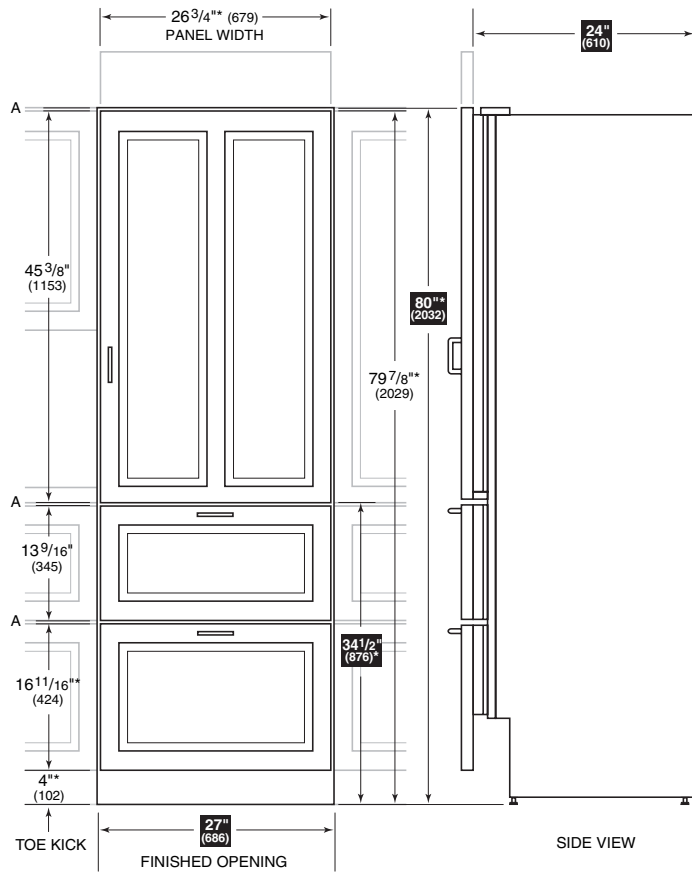

27" (686)  
WIDE MODELS

Installation of a 27" (686) wide Integrated base or tall unit within frameless cabinetry.

\*Dimensions may vary.  
Dimensions are based on a 1/8" (3) reveal. A reveal of up to 1/4" (6) is possible, but panel dimensions need to be adjusted accordingly.

MODEL 736TC(I)

Installation of the Model 736TC(I) Integrated tall unit within frameless cabinetry.

\*Dimensions may vary.  
Dimensions are based on a 1/8" (3) reveal. A reveal of up to 1/4" (6) is possible, but panel dimensions need to be adjusted accordingly.

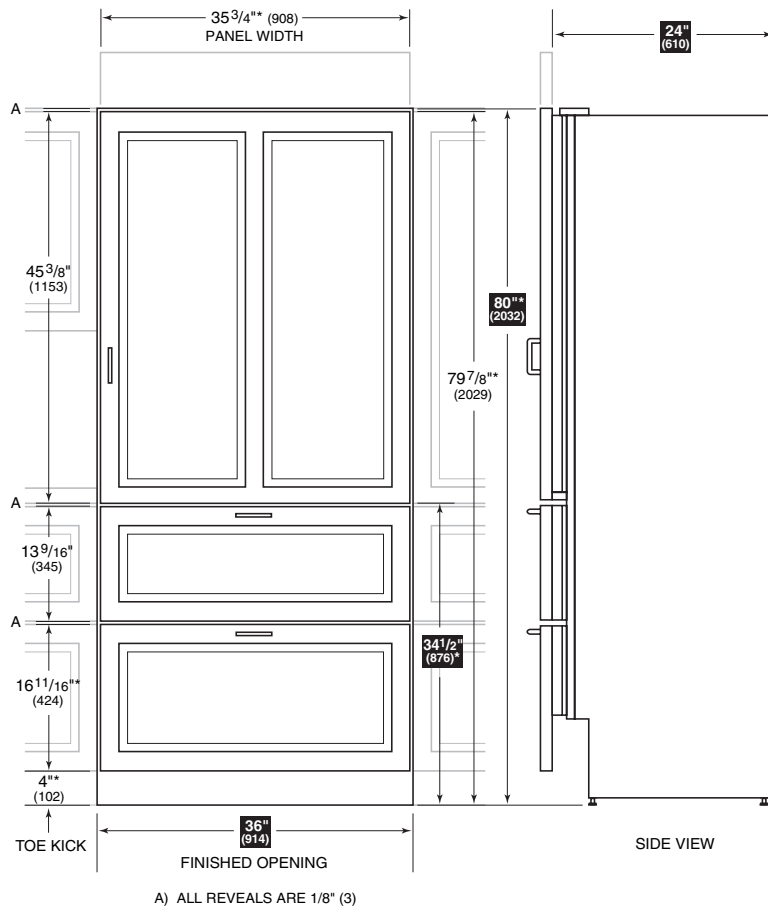



INTEGRATED

## PANEL CONSIDERATIONS

The illustrations below provide panel width dimensions for installation of a single tall unit, 27" (686) wide models and the 36" (914) wide Model 736TC(I).

Illustrations on the following page provide panel width dimensions for installing two tall units side by side, 27" (686) wide models and 36" (914) wide models.

**IMPORTANT NOTE:** The depth of each Integrated model is 24" (610) from the front of the unit to its back. You **must** allow for the thickness of the panel you are applying when planning for the finished rough opening depth if you want the front panel to be flush with surrounding cabinetry. You may have to move the unit back into drywall or bring the cabinets forward to achieve a flush fit.

## INSTALLATION

To install integrated panels, see the detailed procedures outlined in the Sub-Zero Integrated Installation Guide.

### 27" (686) WIDE MODELS

**Panel width dimensions for installation of a 27" (686) wide tall unit.**

*Dimensions are based on a 1/8" (3) reveal. A reveal of up to 1/4" (6) is possible, but panel dimensions need to be adjusted accordingly.*

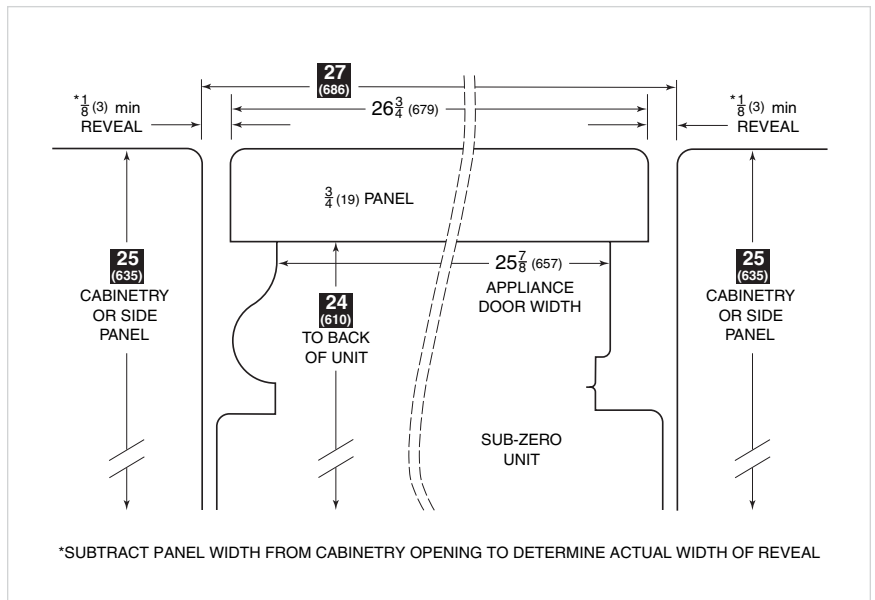

### MODEL 736TC(I)

**Panel width dimensions for installation of a Model 736TC(I) tall unit.**

*Dimensions are based on a 1/8" (3) reveal. A reveal of up to 1/4" (6) is possible, but panel dimensions need to be adjusted accordingly.*

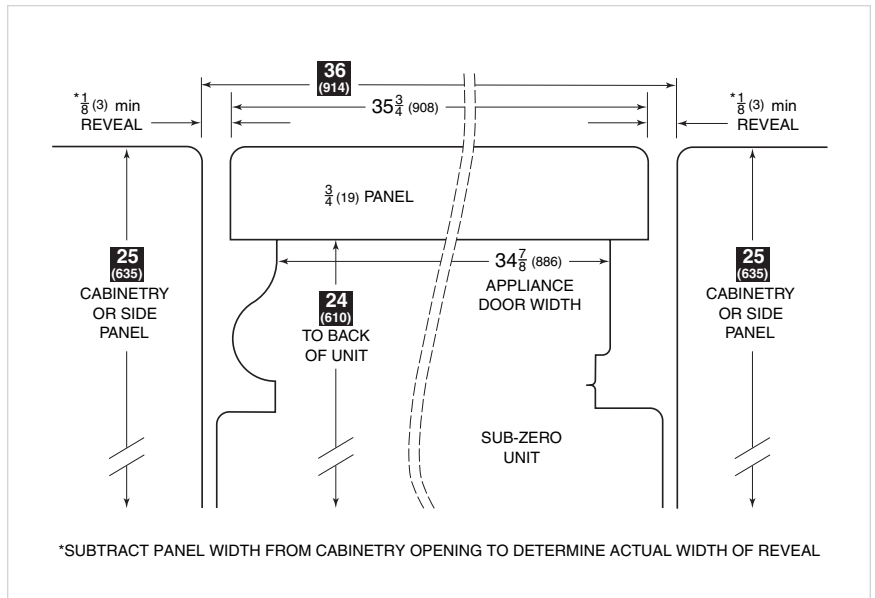



INTEGRATED

**CAUTION**

As the reveal between cabinets and the Integrated unit decreases, the potential exists for severe finger pinching or crushing if a hand or fingers are placed in the opening when the door is closing.

**CAUTION**

When 5/8" (16) or thicker panels are used and a reveal less than 1/4" (6) is maintained, the door panels may cause damage to the Sub-Zero unit when the door is open at the maximum 105° stop. You should use the built-in 90° stop to prevent damage.

PANEL REQUIREMENTS

Door and drawer panels must be a minimum of 5/8" (16) thick.

The door panel cannot exceed 40 lbs (18 kg) and each drawer panel must not exceed 12 lbs (5 kg) for 27" (686) wide units. For Model 736TC(I) the door panel weight limit is 53 lbs (24 kg) and 16 lbs (7 kg) for each drawer panel.

27" (686) WIDE MODELS

Panel width dimensions for installation of two 27" (686) wide tall units side by side.

Dimensions are based on a 1/8" (3) reveal. A reveal of up to 1/4" (6) is possible, but panel dimensions need to be adjusted accordingly.

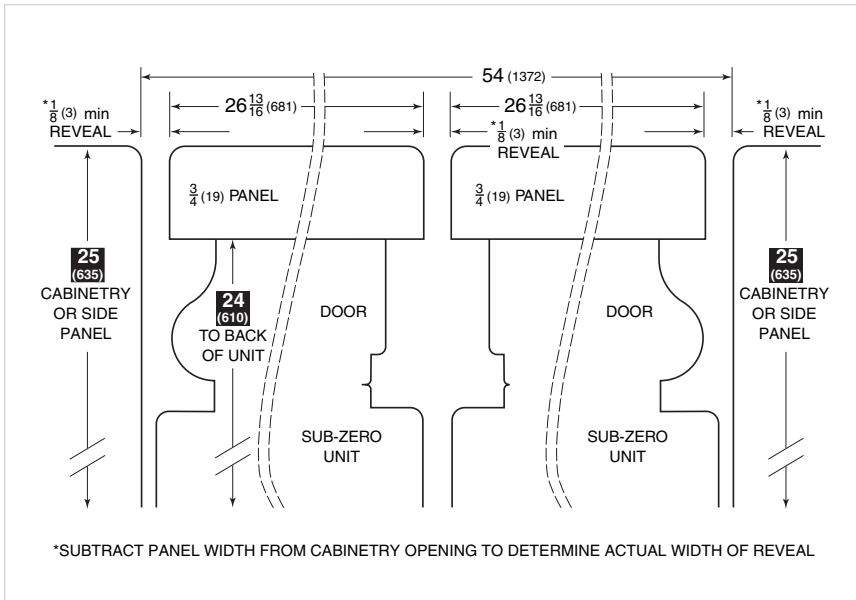

MODEL 736TC(I)

Panel width dimensions for installation of two Model 736TC(I) tall units side by side.

Dimensions are based on a 1/8" (3) reveal. A reveal of up to 1/4" (6) is possible, but panel dimensions need to be adjusted accordingly.

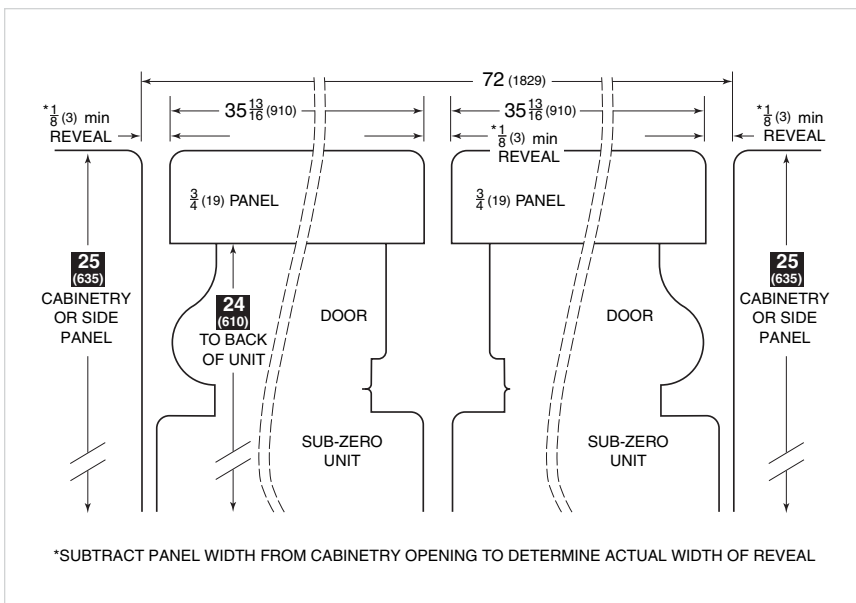

Dimensions are in inches with millimeters in parentheses unless otherwise specified.



INTEGRATED

## INSTALLATION OPTIONS

The illustrations show some typical installations and their dimension considerations. The depth dimension in the illustrations may vary depending on cabinet styles, treatment of countertops or other design options.

**IMPORTANT NOTE:** The depth of each Integrated model is 24" (610) from the front of the unit to its back. Your design may necessitate moving the unit back or cabinets forward to achieve a flush fit. This will require a minimum rough opening depth of 25" (635). Refer to the illustrations.

**NOTE:** In the Installation Options illustrations, the first width dimension shown is for 27" (686) wide units and the second dimension is for the Model 736TC(I).

## DUAL INSTALLATIONS

If two or more Integrated models are installed side by side where there is 2" (51) or less of space between the units, a heater kit is recommended—TTDUAL for two tall units installed side by side and BBDUAL for two base units or a base unit and a tall unit installed side by side. These optional components are available through your Sub-Zero dealer.

## ACCESSORIES

Optional accessories are available through your Sub-Zero dealer, or call Sub-Zero at 800-222-7820. You can also visit our website at [subzero.com](http://subzero.com) and click on the accessories section for your specific model.

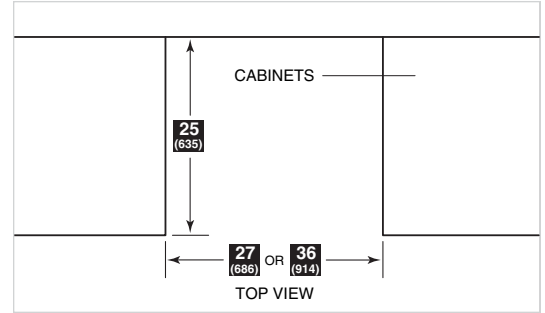

Installation without side panels

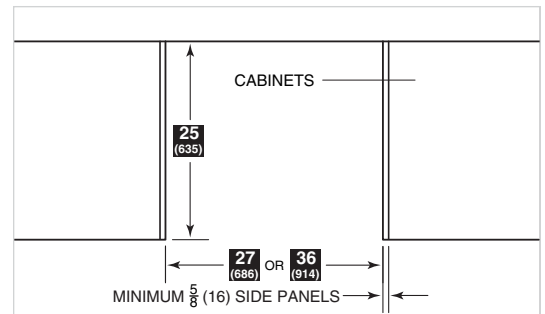

Installation with side panels

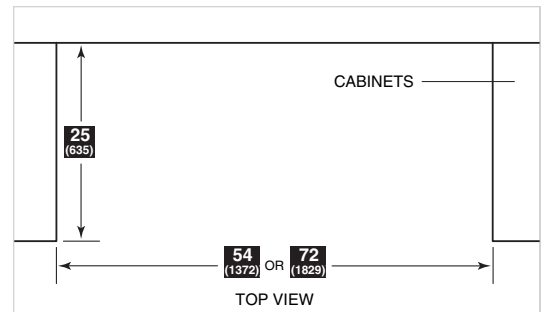

Installation of two units side by side

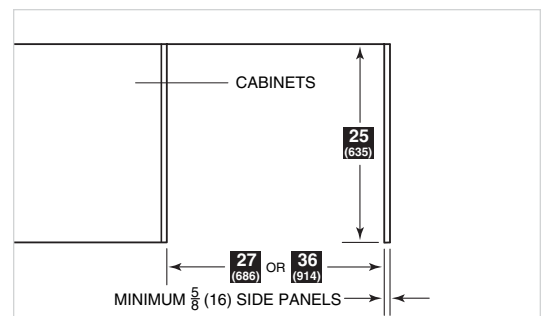

Installation at end of run

## SERVICE INFORMATION

Sub-Zero Freezer Co., Inc.  
Customer Service Department

P. O. Box 44130  
Madison, WI 53744-4130

Service line: 800-222-7820

E-mail: [customerservice@subzero.com](mailto:customerservice@subzero.com)

Website: [subzero.com](http://subzero.com)

If service is necessary, contact customer service by phone or e-mail and include the model and serial number.

Make sure that product registration forms are filled out and returned, to assure that your information is in our database.

Dimensions are in inches with millimeters in parentheses unless otherwise specified.



INTEGRATED

## DOOR PANEL HEIGHT

The height of the door panel can grow beyond 45<sup>1</sup>/<sub>4</sub>" (1149) and exceed the 80" (2032) overall height, as long as you stay below the recommended door panel weight limit.

The top illustration shows how the panel may grow and what you need to consider doing to finish the area in back of the door panel.

**IMPORTANT NOTE:** The valance you use to finish the area behind the door panel must stay behind the front plane of the finished molding.

## TOE KICK CLEARANCE

The toe kick clearance can vary with the height of the lower drawer panel; the maximum panel height is 16<sup>9</sup>/<sub>16</sub>" (421).

**IMPORTANT NOTE:** You must keep a minimum space of 4" (102) clear below the bottom edge of the lower drawer panel so the unit can be properly vented. In addition, any decorative base molding must be removable for possible servicing and cleaning of the condenser.

The bottom illustration shows the area below the lower drawer where the operating mechanical equipment of the Integrated unit is housed.

## PANEL REQUIREMENTS

Door and drawer panels must be a minimum of 5/8" (16) thick.

The door panel cannot exceed 40 lbs (18 kg) and each drawer panel must not exceed 12 lbs (5 kg) for 27" (686) wide units. For Model 736TC(I) the door panel weight limit is 53 lbs (24 kg) and 16 lbs (7 kg) for each drawer panel.

### UPPER VALANCE Tall Models

The depth of each Integrated model is 24" (610) from the front of the unit to its back. Your design may necessitate moving the unit back or cabinets forward to achieve a flush fit. This will require a minimum rough opening depth of 25" (635).

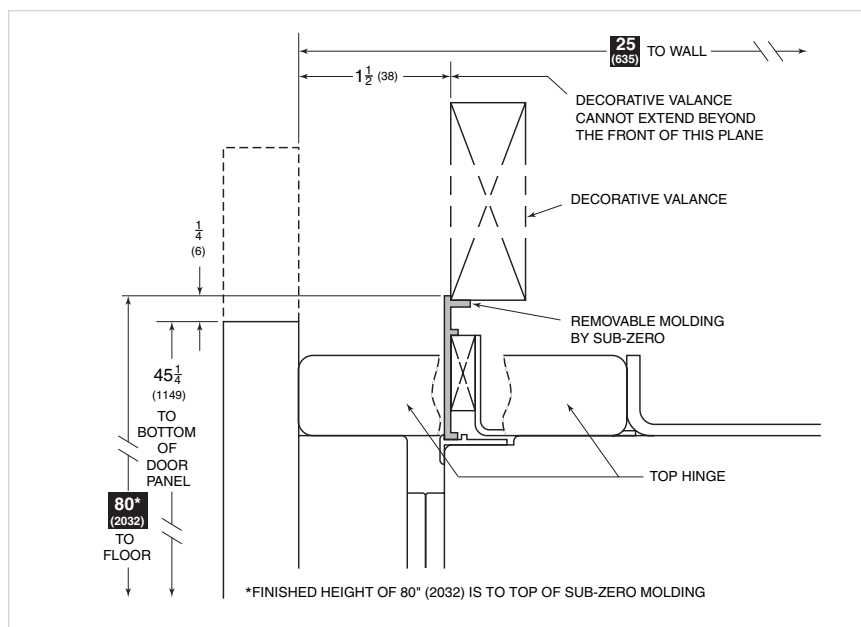

### KICKPLATE AREA Base and Tall Models

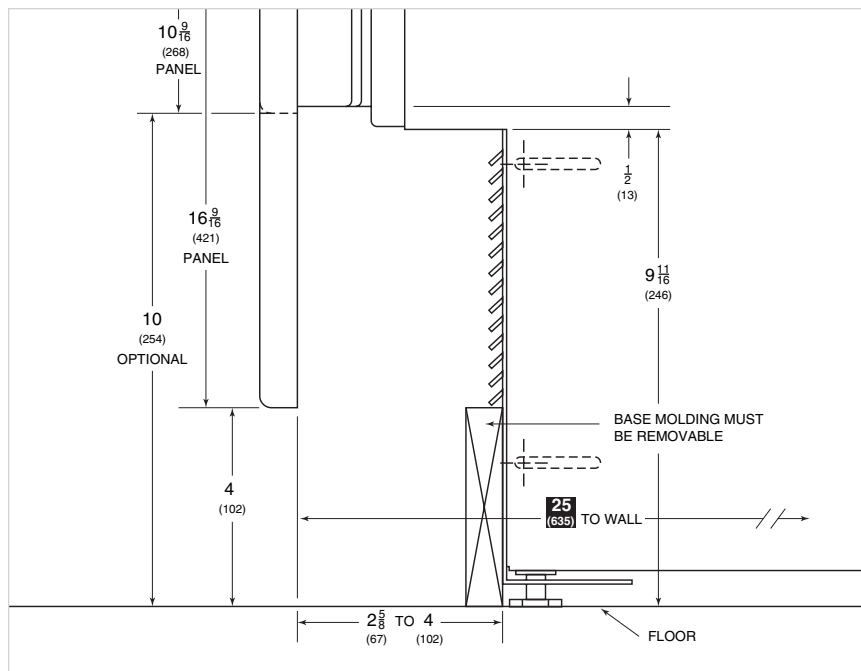



INTEGRATED

### FRAMED CABINERY

**IMPORTANT NOTE:** The depth of each Integrated model is 24" (610) from the front of the unit to its back. Your design may necessitate moving the unit back or cabinets forward to achieve a flush fit.

DOOR CLOSED  
Full-scale (top view)

105° MAXIMUM  
DOOR OPENING  
1/4 scale (top view)

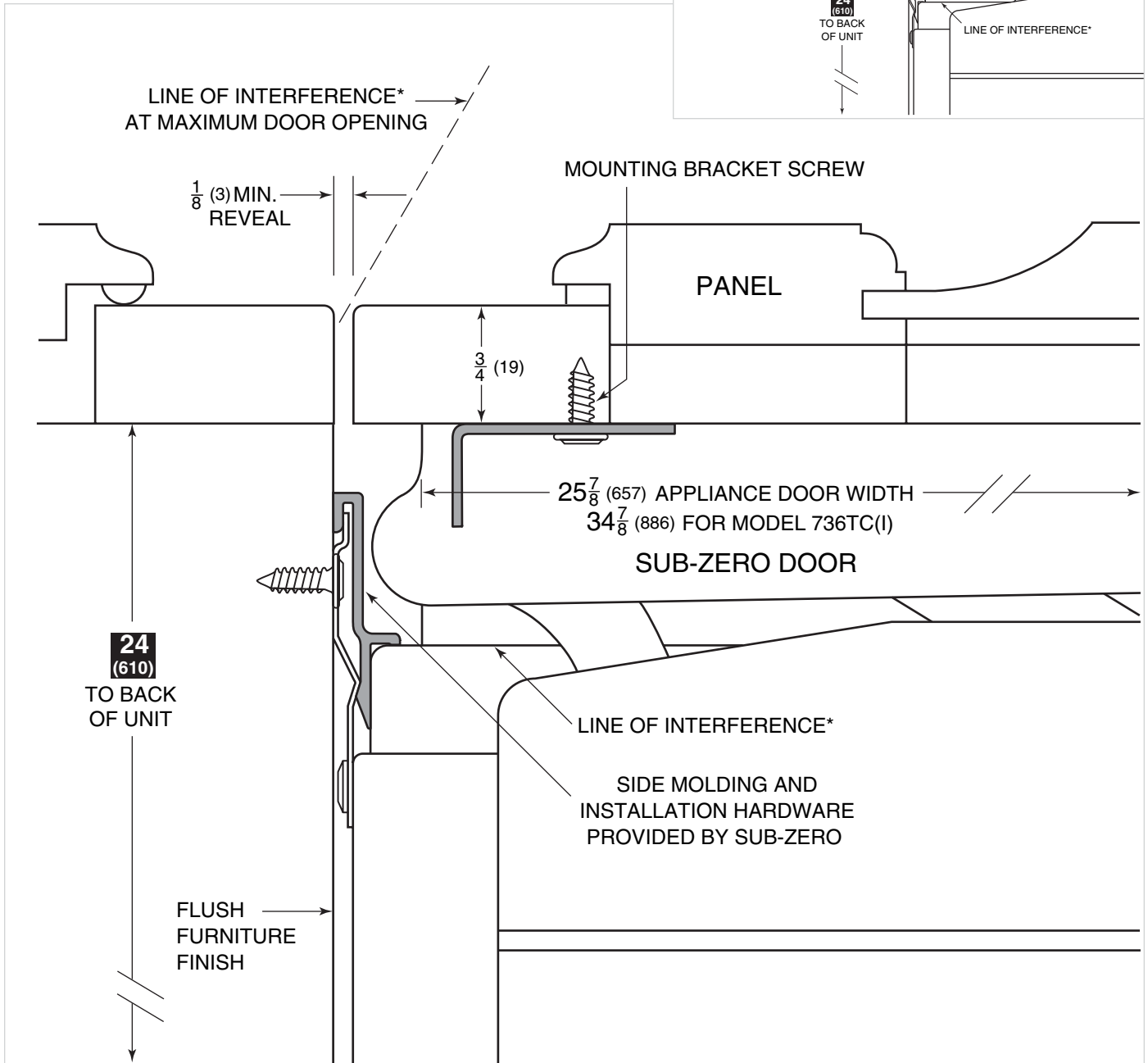
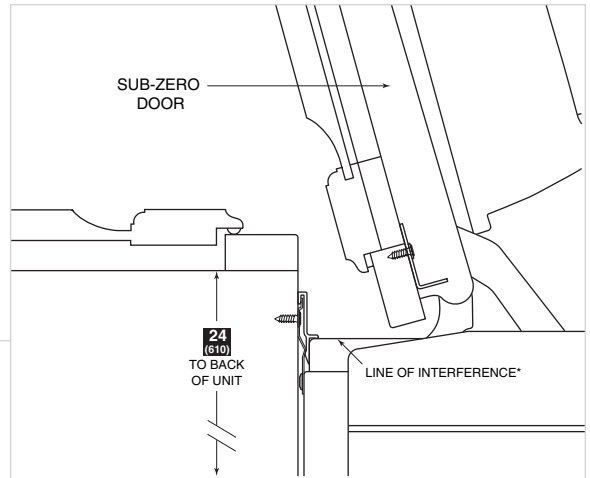

\*If the panel is thicker than 3/4" (19), it is recommended that you utilize the built-in 90° door stop to prevent damage to the panel and face frame.



INTEGRATED

# FRAMELESS CABINETRY

**IMPORTANT NOTE:** The depth of each Integrated model is 24" (610) from the front of the unit to its back. Your design may necessitate moving the unit back or cabinets forward to achieve a flush fit.

DOOR CLOSED  
Full-scale (top view)

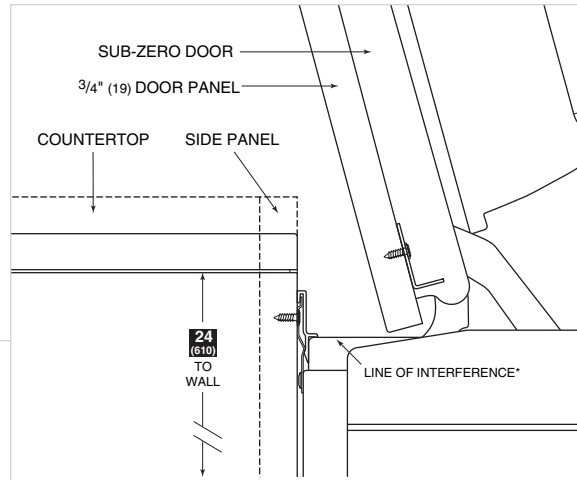

105° MAXIMUM DOOR OPENING  
1/4 scale (top view)  
Adjacent side panel and countertop application.

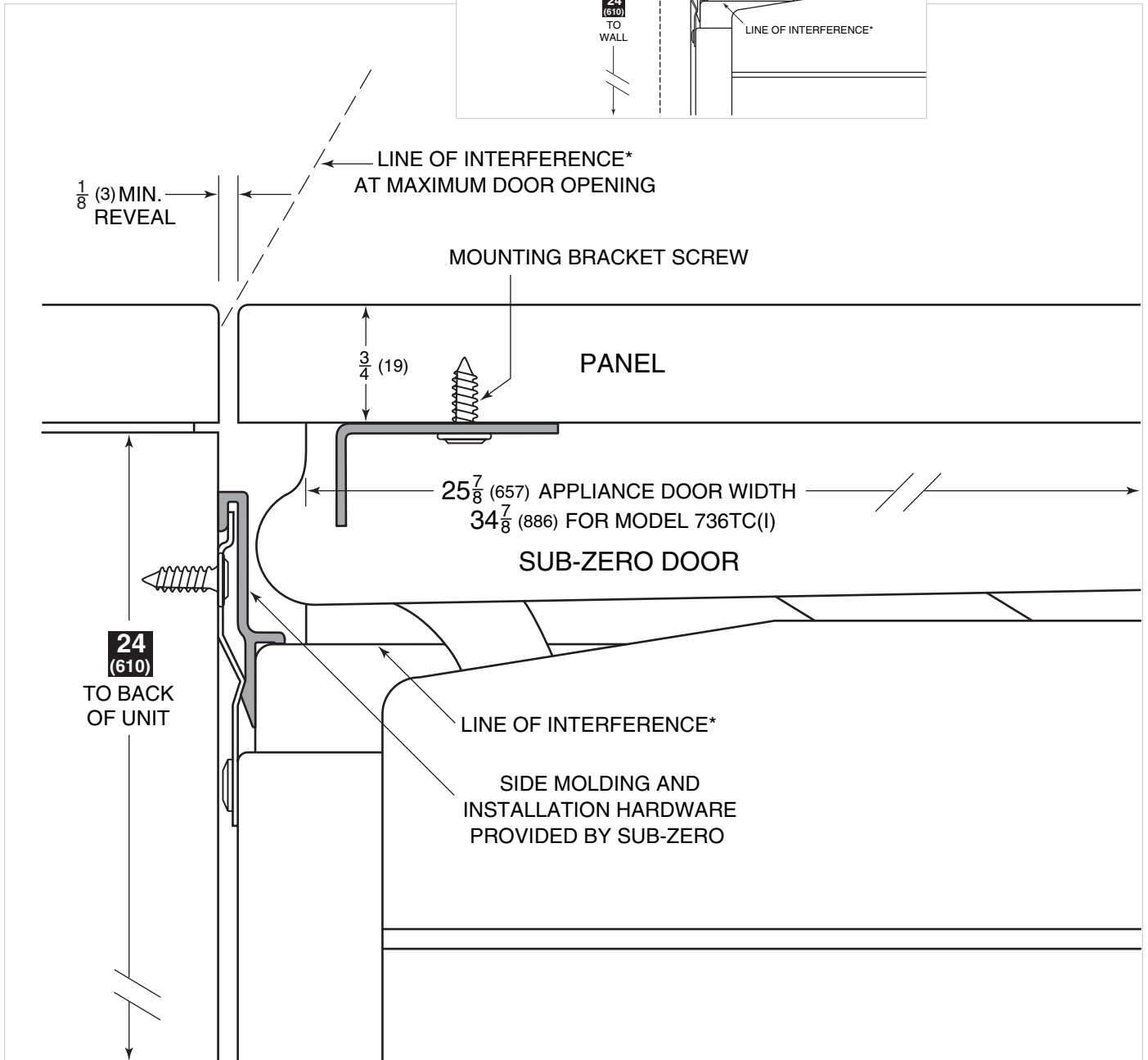

*\*If the panel is thicker than 3/4" (19), it is recommended that you utilize the built-in 90° door stop to prevent damage to the panel and face frame.*



UNDERCOUNTER

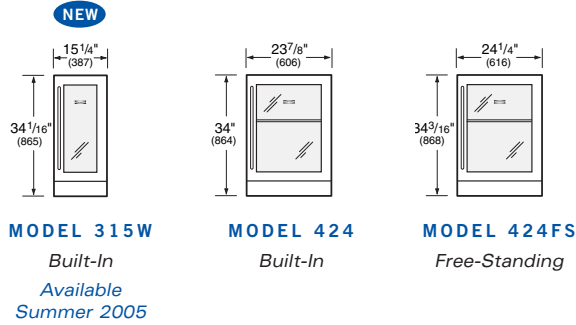

ALL WINE STORAGE

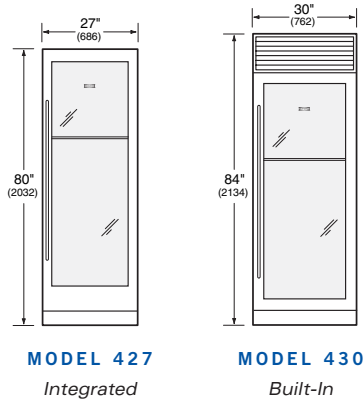

WINE STORAGE | REFRIGERATOR

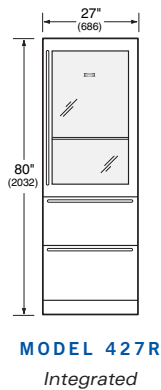

**With the installation of a harness kit, these appliances will be Star-K compliant mid-summer 2005 to meet strict religious regulations in conjunction with specific instructions found on [www.star-k.org](http://www.star-k.org). Model 427R will be Star-K compliant with this harness kit late fall 2005. For details about the harness kit, contact your Sub-Zero dealer.**

The illustrations represent the full line of Wine Storage models. The Model 424FS free-standing unit comes with a classic stainless steel exterior.

Comprehensive installation instructions are shipped with each model. Refer to those instructions in preparing and installing all Sub-Zero products; call Sub-Zero Freezer Company at 800-222-7820; or check our website at [subzero.com](http://subzero.com).

WINE STORAGE

Sub-Zero's innovative addition to its complete line of residential refrigeration is wine storage equipment—the ultimate in beauty, engineering, and attention to detail. From the exterior and the smooth lines of the free-standing Model 424FS classic stainless steel to the ability to use wood on the Built-In and Integrated models, each unit is beautiful.

With the exception of the free-standing Model 424FS, each model is available in three stainless steel finishes and will have the capability of having wood panels applied to the doors. With the Model 427R, you can also apply the wood to the drawers.

New for the summer of 2005 is Model 315W, a single-zone Wine Cooler. It comes only with a glass door and can be ordered as an overlay or classic stainless steel unit.

The free-standing Model 424FS does not require any panels or surrounding cabinetry; it comes with classic stainless steel exterior.

All models will be shipped with glass doors as standard equipment. The glass doors allow one to see the wine that is being stored. Optional solid doors and high altitude glass doors will be treated as special orders and must be ordered 90 days before you expect delivery. Model 315W cannot be ordered with a solid door.

Stainless steel models will be shipped with tubular stainless steel handles, while the overlay models will come with no handle hardware. Optional stainless steel panels and handles for Models 427 and 427R are offered in the classic, platinum and carbon stainless steel finishes and are ordered and shipped as sales accessories. The stainless steel Models 424 and 430 must be ordered in one of three stainless steel finishes of classic, platinum and carbon.

Optional handles are available for all models except the framed and stainless steel Model 430. The framed Model 430 will come with an extruded handle identical in design to our Built-In models.

Standard grille assemblies for the Model 430 will be provided in 1" (25) increments from 10" (254) to 15" (381). The standard height will be 11" (279). The framed model will have a louvered grille, the stainless steel model will feature a heavy-duty grille, and the overlay model will have the panel grille, which accepts decorative panel inserts.

For information regarding specific Wine Storage models, refer to the illustrations in this section.



## FEATURES AND OPTIONS

When looking for wine storage, you no longer have to think only about an undercounter application. Sub-Zero offers you complete flexibility from the perspective of design applications and storage capabilities.

Model 315W, a single-zone Wine Cooler, comes as an overlay or classic stainless steel unit and is offered only with a glass door.

Model 424 comes in the overlay and stainless steel door panel configurations. Model 424FS (free-standing) is identical to the Model 424 but with classic stainless steel exterior and is designed to be attractive in a stand-alone setting. Models 424 and 424FS are available in either a glass or solid door model.

Models 427 and 427R are offered as integrated or stainless steel and are available in either a glass or solid door model. Optional stainless steel panels and handles are offered in classic, platinum and carbon stainless steel finishes at the 80" (2032) height, and only classic stainless steel at the 84" (2134) height. Stainless steel panels are available as sales accessories.

Model 430 comes in the framed, overlay and stainless steel options and is available in either a glass or solid door model. Stainless steel Model 430 must be ordered in one of the stainless steel finishes of classic, platinum and carbon.

**Built-In Look.** Sub-Zero offers you a host of design alternatives to choose from when selecting the look you want. Wood or stainless steel, framed, overlay or integrated.

**Dual Zone System\*.** With the exception of the single-zone Model 315W Wine Cooler, all Wine Storage models allow you to have precise temperature control within one degree of your pre-set temperature in each of the two wine compartments.

**Dual Refrigeration System\*.** In a similar fashion to our Built-In, each Wine Storage model has dual refrigeration so your client will have specific, individual temperature control of the two wine compartments.

**Electronic Controls\*.** Microprocessor offers touch pad controls that are easy to understand and that set the temperatures accurately.

**Display Shelf\*.** This beautiful shelf offers your clients the opportunity to display those prize bottles or magnums of wine in their collection. It is illuminated with discreet lighting mounted in the control panel. (Not available with Models 315W, 424 and 424FS.)

**Storage Shelves.** The sturdy, rustproof wire shelves can easily accommodate standard 750 ml bottles, half bottles, as well as magnums. All the shelves are finished off with a natural cherry wood facing. In addition, all shelves will enable you to be sure the wine is stored properly and that the corks are in contact with the bottles' contents.

**Roller Assembly.** All shelves have a roller assembly, which enables you to have a three-quarter extension for easy access to all bottles of stored wine.

**Service Alert\*.** An indicator light will let you know if service may be necessary.

**Home Alarm\*.** Wiring connections give you the option of hooking the Wine Storage unit up to your home security system.

**Discreet Lighting.** Our soft low-wattage lighting is independent of door opening.

**Correct Temperature\*.** The range of each temperature zone is 38°F (3°C) to 65°F (18°C), and your set temperature is digitally displayed in the control panel.

**Humidity.** Proper humidity is maintained throughout the entire unit.

**UV Protection.** The tinted glass minimizes the amount of ultraviolet light entering the unit.

**Lock\*.** A lock will be offered as an option for all Wine Storage models. The lock is offered as a sales accessory and should be ordered through your Sub-Zero dealer. Special planning is necessary when ordering locks for Models 427 and 427R; see page 61 for details.

**Solid Door\*.** If you would like to order a model without glass, you have that option. This will be treated as a special order and must be ordered 90 days before you expect delivery.

**High Altitude Glass.** For installations above 5,000' (1524 m) in elevation, we offer the high altitude glass as a special order. The high altitude glass door is standard on Model 315W.

**Tight Seal.** Magnetic gaskets around the doors give extra-tight seals.

**Kickplate.** The solid, adjustable kickplate gives a true built-in look and conforms to American Institute of Architects standards.

**Front Venting.** All Sub-Zero Wine Storage models are designed for mechanical system airflow at the front of the appliance. Decorative panels must not cover louvered surfaces or prevent removal of louvered components.

## SUB-ZERO WARRANTY

Sub-Zero products are covered by a two, five and twelve year residential warranty (exclusions apply). See warranty details at the end of this guide.

## ACCESSORIES

Optional accessories are available through your Sub-Zero dealer, or call Sub-Zero at 800-222-7820. You can also visit our website at [subzero.com](http://subzero.com) and click on the accessories section for your specific model.

\*Not available with Model 315W.

Dimensions in parentheses are in millimeters unless otherwise specified.



WINE STORAGE

### MODEL 315W

**NEW** Available Summer 2005

UNDERCOUNTER  
BUILT-IN

#### MODEL OPTIONS

Overlay Design **315W/O**  
Classic Stainless Steel **315W/S**

#### SPECIFICATIONS

Overall Width **15<sup>1</sup>/<sub>4</sub>" (387)**  
Overall Height **34<sup>1</sup>/<sub>16</sub>" (865)**  
Overall Depth **24" (610)**  
Wine Storage Capacity **26 bottles\***  
Min Height Required **34<sup>1</sup>/<sub>16</sub>" (865)**  
Door Swing Clearance **16<sup>5</sup>/<sub>8</sub>" (422)**  
Specify Door Swing **LH or RH**  
Shipping Wt (O) **114 lbs (52 kg)**  
Shipping Wt (S) **118 lbs (54 kg)**

#### FEATURES

1 Temperature Zone  
4 (750 ml) Bottles per Standard Shelf  
6 Standard Shelves (24 bottles\*)  
1 Fixed Bottle Holder (2 bottles\*)  
Full-View High Altitude Glass Door

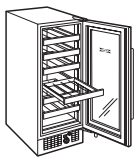

MODEL 315W

### MODEL 424

UNDERCOUNTER  
BUILT-IN

#### MODEL OPTIONS

Overlay Design **424/O**  
Classic Stainless Steel **424/S**  
Platinum Stainless Steel **424/P**  
Carbon Stainless Steel **424/B**

Full-View Glass Door (standard)  
High Altitude Glass Door\*\*  
Solid Door

#### SPECIFICATIONS

Overall Width **23<sup>7</sup>/<sub>8</sub>" (606)**  
Overall Height **34" (864)**  
Overall Depth **24" (610)**  
Wine Storage Capacity **46 bottles\***  
Min Height Required **34<sup>1</sup>/<sub>4</sub>" (870)**  
Door Swing Clearance **25<sup>3</sup>/<sub>8</sub>" (645)**  
Specify Door Swing **LH or RH**  
Shipping Wt (glass) **190 lbs (86 kg)**  
Shipping Wt (glass/S/P/B) **195 lbs (88 kg)**  
Shipping Wt (solid) **185 lbs (84 kg)**

#### FEATURES

2 Temperature Zones  
8 (750 ml) Bottles per Standard Shelf  
2 Top Zone Shelves (16 bottles\*)  
3 Bottom Zone Shelves (24 bottles\*)  
1 Fixed Bottle Holder (6 bottles\*)  
Full-View Glass Door

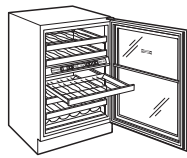

MODEL 424

### MODEL 424FS

UNDERCOUNTER  
FREE-STANDING

#### MODEL OPTIONS

Full-View Glass Door (standard)  
High Altitude Glass Door\*\*  
Solid Door

#### SPECIFICATIONS

Overall Width **24<sup>1</sup>/<sub>4</sub>" (616)**  
Overall Height **34<sup>3</sup>/<sub>16</sub>" (868)**  
Overall Depth **24<sup>5</sup>/<sub>8</sub>" (625)**  
Wine Storage Capacity **46 bottles\***  
Door Swing Clearance **25<sup>3</sup>/<sub>8</sub>" (645)**  
Specify Door Swing **LH or RH**  
Shipping Wt **220 lbs (100 kg)**

#### FEATURES

2 Temperature Zones  
8 (750 ml) Bottles per Standard Shelf  
2 Top Zone Shelves (16 bottles\*)  
3 Bottom Zone Shelves (24 bottles\*)  
1 Fixed Bottle Holder (6 bottles\*)  
Full-View Glass Door  
Classic Stainless Steel Exterior  
and Door Frame

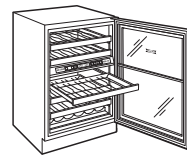

MODEL 424FS

\*750 ml bottles.

\*\*High altitude glass doors are for installations at or above 5,000' (1524 m) in elevation and will be treated as a special order. Please allow 90 days for delivery. When ordering, add an (HA) before the (G) to obtain the correct model number.

\*\*\*Optional stainless steel panels and handles are ordered and shipped as sales accessories. For additional information on panel and handle sizes and applications, go to [subzero.com](http://subzero.com) and review the accessories section under each model for specifics.

#### ACCESSORIES

Contact your Sub-Zero Dealer

Classic stainless steel front panels—platinum and carbon available in certain sizes (Models 427 and 427R)\*

Tubular handles in classic, platinum and carbon stainless steel

Front, side and grille panels (framed Model 430)\*

Louvered, panel or stainless steel grilles in varied heights (Model 430)\*

UL-approved door lock kit

Dual installation heater kit (Models 427 and 427R)\*

\*Accessory is available only for models listed.



### MODEL 427

ALL WINE STORAGE

#### MODEL OPTIONS

- Full-View Glass Door (standard)
- High Altitude Glass Door\*\*
- Solid Door

#### SPECIFICATIONS

Overall Width	<b>27" (686)</b>
Overall Height	<b>80" (2032)</b>
Overall Depth	<b>24" (610)</b>
Wine Storage Capacity	<b>132 bottles*</b>
Min Height Required	<b>79 1/2" (2019)</b>
Door Swing Clearance	<b>25 1/2" (648)</b>
Specify Door Swing	<b>LH or RH</b>
Shipping Wt (glass)	<b>395 lbs (179 kg)</b>
Shipping Wt (solid)	<b>386 lbs (175 kg)</b>

#### FEATURES

- 2 Temperature Zones
- 9 (750 ml) Bottles per Standard Shelf
- 5 Top Zone Shelves (45 bottles\*)
- 9 Bottom Zone Shelves (81 bottles\*)
- 1 Display Shelf (6 bottles\*)
- Full-View Glass Door

#### PANEL OPTIONS

- Integrated
- Classic, platinum or carbon stainless steel finish (includes handle)\*\*\*

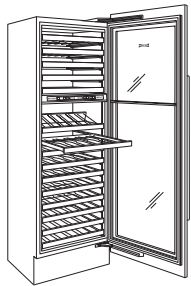

MODEL 427

### MODEL 430

ALL WINE STORAGE

#### MODEL OPTIONS

- Framed Design **430/F**
- Overlay Design **430/O**
- Classic Stainless Steel **430/S**
- Platinum Stainless Steel **430/P**
- Carbon Stainless Steel **430/B**
- Full-View Glass Door (standard)
- High Altitude Glass Door\*\*
- Solid Door

#### SPECIFICATIONS

Overall Width	<b>30" (762)</b>
Overall Height	<b>84" (2134)</b>
Overall Depth	<b>24" (610)</b>
Wine Storage Capacity	<b>147 bottles*</b>
Min Height Required	<b>83" (2108)</b>
Door Swing Clearance	<b>30 1/8" (765)</b>
Specify Door Swing	<b>LH or RH</b>
Shipping Wt (glass)	<b>435 lbs (197 kg)</b>
Shipping Wt (glass/S/P/B)	<b>445 lbs (202 kg)</b>
Shipping Wt (solid)	<b>412 lbs (187 kg)</b>

#### FEATURES

- 2 Temperature Zones
- 10 (750 ml) Bottles per Standard Shelf
- 5 Top Zone Shelves (50 bottles\*)
- 9 Bottom Zone Shelves (90 bottles\*)
- 1 Display Shelf (7 bottles\*)
- Full-View Glass Door

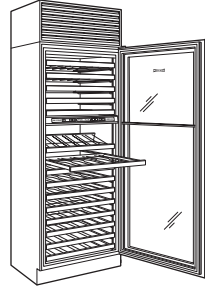

MODEL 430

### MODEL 427R

WINE STORAGE | REFRIGERATOR

#### MODEL OPTIONS

- Full-View Glass Door (standard)
- High Altitude Glass Door\*\*
- Solid Door

#### SPECIFICATIONS

Overall Width	<b>27" (686)</b>
Overall Height	<b>80" (2032)</b>
Overall Depth	<b>24" (610)</b>
Wine Storage Capacity	<b>78 bottles*</b>
Refrigerator Capacity	<b>5.3 cu ft (150 L)</b>
Min Height Required	<b>79 1/2" (2019)</b>
Door Swing Clearance	<b>25 1/2" (648)</b>
Specify Door Swing	<b>LH or RH</b>
Drawer Clearance	<b>19 1/2" (495)</b>
Shipping Wt (glass)	<b>410 lbs (186 kg)</b>
Shipping Wt (solid)	<b>406 lbs (184 kg)</b>

#### FEATURES

- 3 Temperature Zones
- 2 Refrigerated Drawers
- 9 (750 ml) Bottles per Standard Shelf
- 6 Top Zone Shelves (54 bottles\*)
- 2 Bottom Zone Shelves (18 bottles\*)
- 1 Display Shelf (6 bottles\*)
- Full-View Glass Door

#### PANEL OPTIONS

- Integrated
- Classic, platinum or carbon stainless steel finish (includes handles)\*\*\*

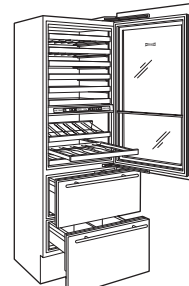

MODEL 427R

*NOTE: For Wine Storage standard glass door models, add (G) to the model number and for solid door models, add (S) to the model number (example 424G or 424S). The exception is Model 315W which is available as a glass door model only.*

*Dimensions in parentheses are in millimeters unless otherwise specified.*



## PLANNING INFORMATION

Review the Overall Dimensions and Installation Specifications illustrations for your Wine Storage model on the following pages. These specifications cover all the details you need to know about space allocation and placement of electrical, whether the models are framed, overlay, stainless steel or integrated.

All Wine Storage models must be installed so that the door can open a minimum of 90° or you will have problems pulling the wine shelves out. Refer to the door clearance and door swing information.

For corner installations, you need allow for a minimum 3" (76) filler so the door can open to 90°. If you are using larger handle hardware, you will also need to take that into account.

For a maximum 90° door opening, use the door stop built into the hinge system of Model 427. An optional 90° door stop kit for Model 430 is available from your Sub-Zero dealer.

If you are installing a Wine Storage unit next to an existing Sub-Zero unit, you may have to allow for a filler strip.

If you are installing a Model 427 or 427R Wine Storage unit next to an existing Integrated Sub-Zero unit, with 2" (51) or less between the units, an optional heater kit (BBDUAL or TTDUAL) will need to be installed to prevent moisture from forming between the units. This optional kit is available through your Sub-Zero dealer.

If you will be connecting the unit to a home security system, you must allow a minimum of 36" (914) of the system's wiring to be routed in the electrical area designated for your model.

**IMPORTANT NOTE:** The anti-tip bracket must be installed to prevent the unit from tipping forward.

## ELECTRICAL REQUIREMENTS

A 115 V AC, 60 Hz, 15 amp circuit breaker and electrical supply are required. A separate circuit servicing only this appliance is required.

All Sub-Zero Wine Storage models are equipped with a power supply cord with a 3-prong grounding plug, which must be plugged into a mating 3-prong grounding-type wall receptacle. Follow the National Electrical Code and local codes and ordinances when installing the receptacle. Refer to the Installation Specifications illustrations on the following pages for electrical placement for your model.

**IMPORTANT NOTE:** A ground fault circuit interrupter (GFCI) is not recommended and may cause interruption of operation.

## ACCESSORIES

Optional accessories are available through your Sub-Zero dealer, or call Sub-Zero at 800-222-7820. You can also visit our website at [subzero.com](http://subzero.com) and click on the accessories section for your specific model.

## INSTALLATION

Refer to the installation instructions shipped with each Sub-Zero product for detailed specifications.



OVERALL DIMENSIONS

*Undercounter Wine Storage*

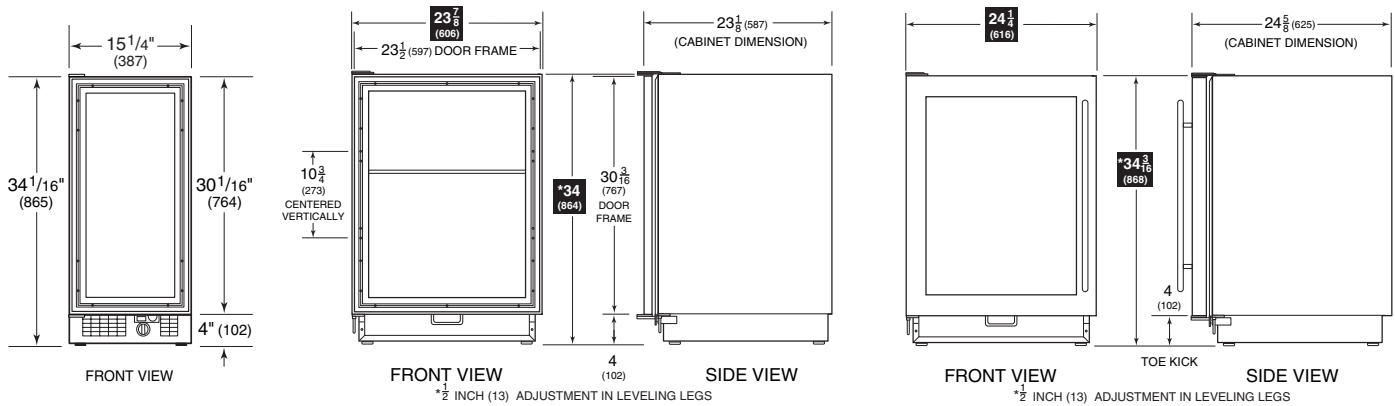

MODEL 315W

*Built-In*

Width 15 1/4" (387)  
Height 34 1/16" (865)  
Depth 24" (610)

MODEL 424

*Built-In*

Width 23 7/8" (608)  
Height 34" (864)  
Depth 24" (610)

MODEL 424FS

*Free-Standing*

Width 24 1/4" (616)  
Height 34 3/16" (868)  
Depth 24 5/8" (625)

UNDERCOUNTER

**Model 315W**  
*Built-In*

**Model 424**  
*Built-In*

**Model 424FS**  
*Free-Standing*

*Note the location of pre-drilled holes for optional handle hardware.*

INSTALLATION SPECIFICATIONS

*Undercounter Models*

**Model 315W**

- A) Rough Opening Width 15 1/4" (387)
- B) Rough Opening Height 34 1/2" (876)
- C) Min Door Clearance 16 5/8" (422)
- D) Min Clearance at 90° 17 1/4" (438)

**Model 424**

- A) Rough Opening Width 24" (610)
- B) Rough Opening Height 34 1/2" (876)
- C) Min Door Clearance 25 3/8" (644)
- D) Min Clearance at 90° 26" (660)

**Model 424FS\***

- C) Min Door Clearance 25 3/8" (644)
- D) Min Clearance at 90° 26" (660)

*\*Free-standing Model 424FS requires no surrounding cabinetry.*

*Dimensions are for finished rough openings.*

*Door swing clearances are based on stainless steel door and handle dimensions.*

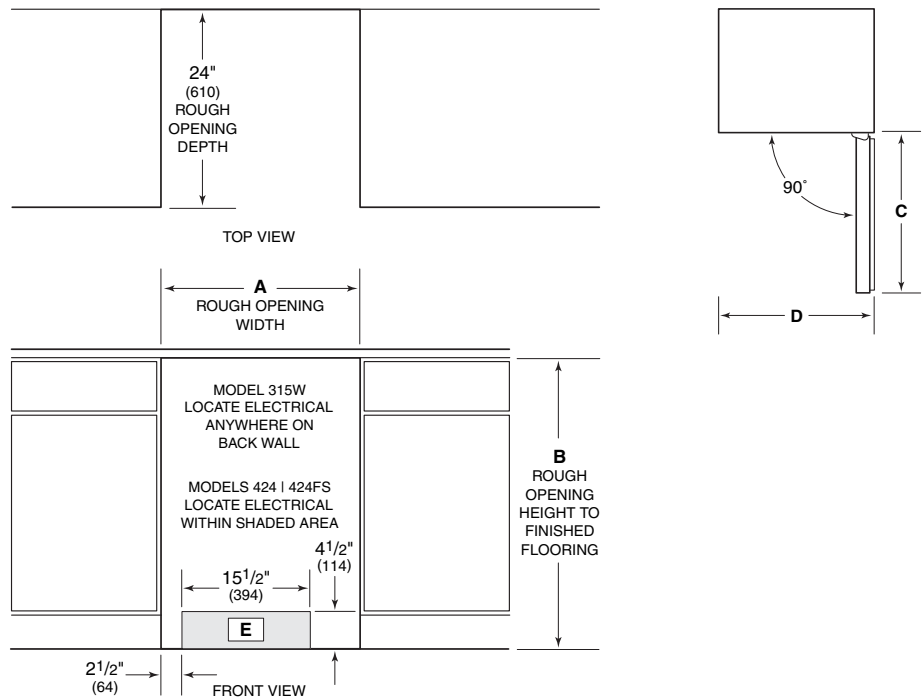

*Dimensions are in inches with millimeters in parentheses unless otherwise specified.*



WINE STORAGE

OVERALL DIMENSIONS  
All Wine Storage - Model 427

INTEGRATED

Model 427  
All Wine Storage

Model 427R  
Wine Storage | Refrigerator

OVERALL DIMENSIONS  
Model 427 | 427R

Width 27" (686)  
Height 80" (2032)  
Depth 24" (610)

Note the location of pre-drilled holes for optional handle hardware.

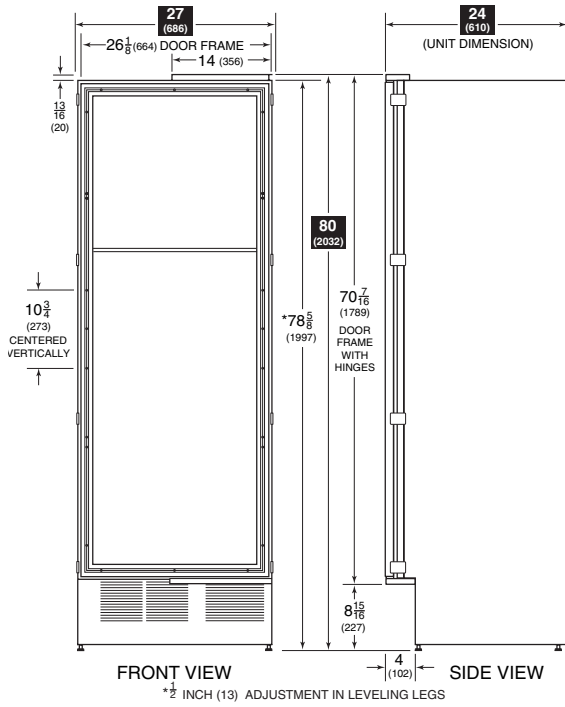

Wine Storage | Refrigerator - Model 427R

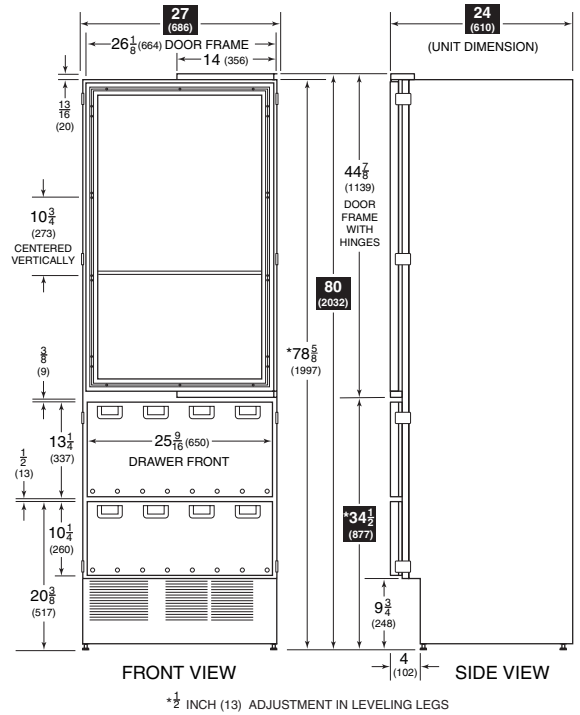

INSTALLATION SPECIFICATIONS  
Models 427 | 427R

Dimensions are for finished rough openings.

Door swing clearances are based on stainless steel door and handle dimensions.

IMPORTANT NOTE: The depth of Models 427 and 427R is 24" (610) from the front of the unit to its back. Your design may necessitate moving the unit back or cabinets forward to achieve a flush fit. This will require a minimum rough opening depth of 25" (635).

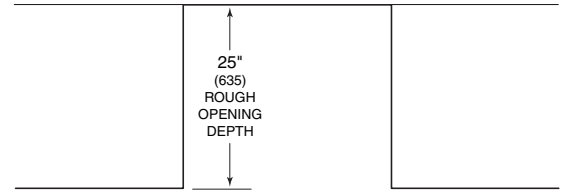

TOP VIEW

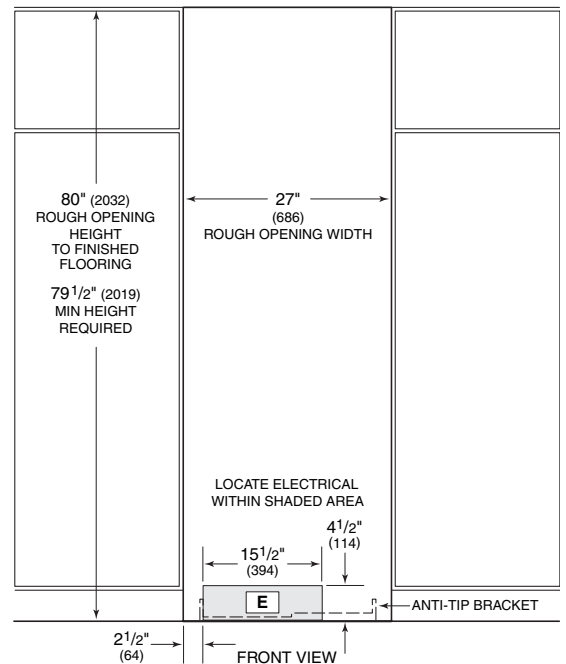
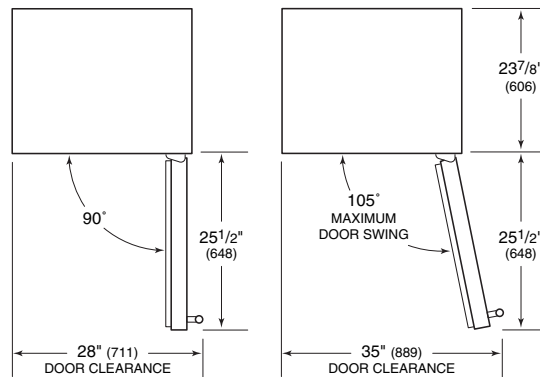



WINE STORAGE

### OVERALL DIMENSIONS

All Wine Storage - Model 430

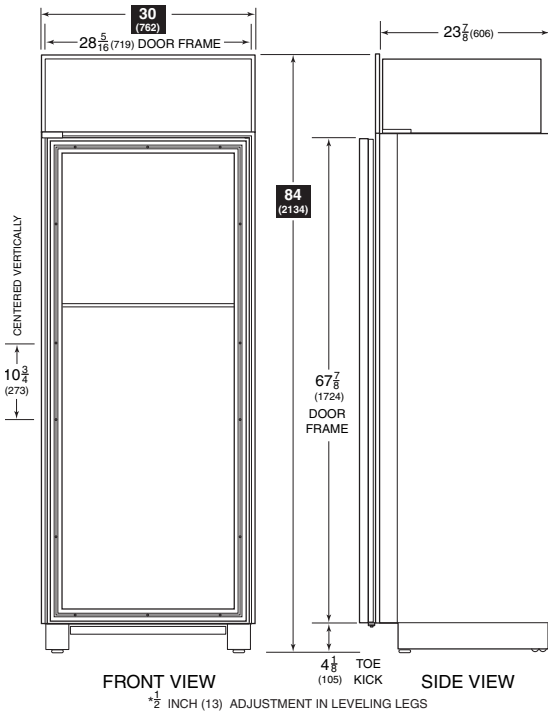

ALL WINE STORAGE

Model 430 Built-In

OVERALL DIMENSIONS Model 430

Width 30" (762)  
Height 84" (2134)  
Depth 24" (610)

Note the location of pre-drilled holes for optional handle hardware.

### INSTALLATION SPECIFICATIONS

All Wine Storage - Model 430

Dimensions are for finished rough openings.

Door swing clearances are based on stainless steel door and handle dimensions.

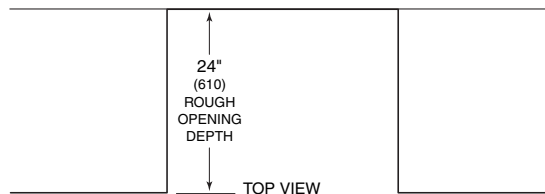
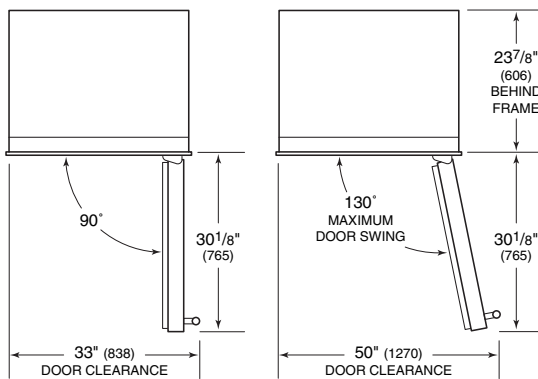

### INSTALLATION

Refer to the installation instructions shipped with each Sub-Zero product for detailed specifications.

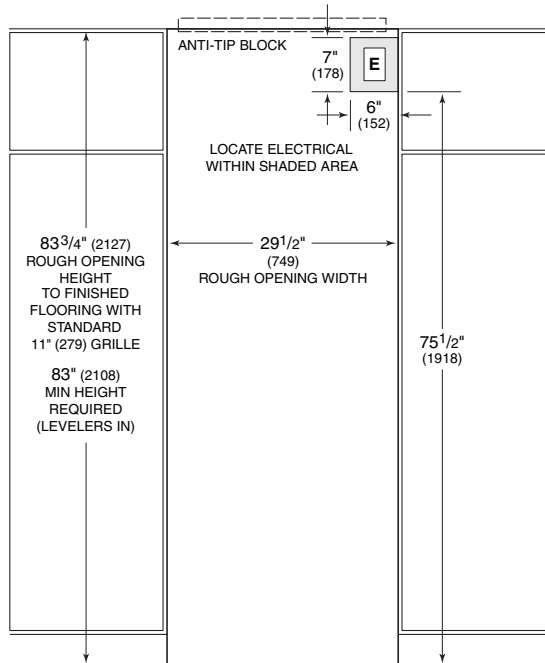

Dimensions are in inches with millimeters in parentheses unless otherwise specified.



### INTEGRATING CABINETRY

Unless you are installing a stainless steel model, you will need to provide a complete door panel in the instance of a solid door model, or a frame for the glass door application where wine will be seen from the outside. If you order a stainless steel unit, Models 315W, 424, 424FS and 430 will be shipped with their panels and hardware installed and you will merely install the Sub-Zero. However, for Models 427 and 427R, you will have to have the stainless steel panels and handles installed.

Wine Storage solid door models are available as a special order. You must allow 90 days from the time of order until you can expect delivery.

### MODEL 424FS – FREE-STANDING

The free-standing Model 424FS does not require any panels or surrounding cabinetry. It has a beautiful classic stainless steel exterior, door frame and handle. Refer to the Overall Dimensions illustration for the Model 424FS.

### ACCESSORIES

Optional accessories are available through your Sub-Zero dealer, or call Sub-Zero at 800-222-7820. You can also visit our website at [subzero.com](http://subzero.com) and click on the accessories section for your specific model.

### CABINETRY DIMENSIONS

*Model 315W*

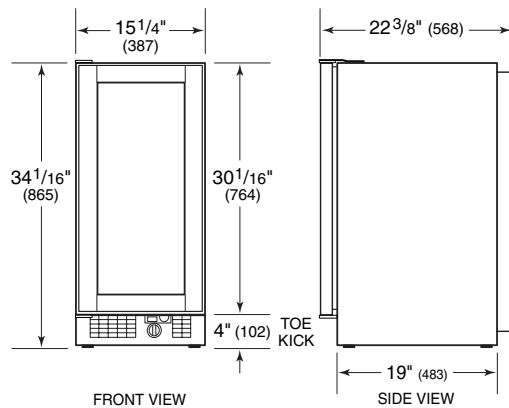

### OVERLAY PANEL SPECIFICATIONS

*Model 315W*

Door Panel Width	<b>15" (381)</b>
Door Panel Height	<b>30 1/16" (764)</b>
Min Width of Rails and Stiles	<b>2 1/4" (57)</b>
Door Frame Panel Weight Limit	<b>10 lbs (5 kg)</b>
Min Panel Thickness	<b>5/8" (16)</b>



## OVERLAY PANELS – MODELS 315W AND 424

The overlay panel applied to Models 315W and 424 should not be confused with the Built-In overlay panel application. The overlay panel will consist of only a frame and would be either the 5/8" (16) or 3/4" (19) thick panel you may be using. It is affixed directly to the door itself with screws through a series of pre-drilled holes in the perimeter of the door itself. You do not need any backer or spacer panel.

Refer to the Overall Dimensions and Cabinetry Dimensions illustrations for Models 315W and 424 to give you a better idea of the exact space our unit needs and how the panel fits in relationship with the unit.

The glass door opening of the standard Model 315W and 424 are designed to be exposed to room air circulation. Decorative overlays on the glass should be kept to a minimum. Also, rails and stiles can be increased in size but should not exceed cabinet manufacturers' standard width. They cannot exceed overall door panel dimensions specified, as they would interfere with the operation of the door. The back sides of rails and stiles that will be visible through the glass door will need to be finished. Also, the inside edges of the frames must be finished to match the front surface.

The Overall Dimensions illustrations show the location of predrilled holes for optional handle hardware. Refer to page 64 for specifics about installing handles on this overlay application.

**IMPORTANT NOTE:** Wine Storage models with a solid door are available as a special order and require 90 days for delivery. When ordering panels for a solid door unit, follow the overall panel dimensions listed; rail and stile dimensions do not apply. Model 315W is not available with a solid door.

**IMPORTANT NOTE:** When planning to install the Model 315W or 424 next to adjoining cabinetry, you must make provisions to allow the door to open to a maximum of 145° and not interfere with the door panel. Refer to the full-scale illustration at the end of this section.

## INSTALLATION

To install overlay panels, see the detailed procedures outlined in the Sub-Zero Wine Storage Installation Guide.

### ⚠ CAUTION

A solid panel must not be installed on a glass door unit, as this may cause moisture to form behind the panel.

## CABINETRY DIMENSIONS

### Model 424

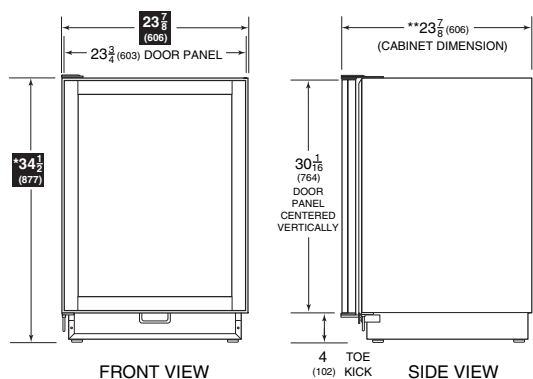

\*\* MODEL 424/S (STAINLESS STEEL WRAPPED DOOR) FINISHES OFF AT 23 3/8" INCHES DEEP

## OVERLAY PANEL SPECIFICATIONS

### Model 424

Door Panel Width	<b>23 3/4" (603)</b>
Door Panel Height	<b>30 1/16" (764)</b>
Min Width of Rails and Stiles	<b>2 1/4" (57)</b>
Door Frame Panel Weight Limit	<b>10 lbs (5 kg)</b>
Solid Door Panel Weight Limit	<b>20 lbs (9 kg)</b>
Min Panel Thickness	<b>5/8" (16)</b>

Dimensions are in inches with millimeters in parentheses unless otherwise specified.



## INTEGRATED PANELS – MODELS 427 | 427R

The integrated full panels or frame panels for glass doors for these models will follow some of the identical planning processes used with the Integrated line. The installation of the door panels is completely different, however. Rather than using the mounting hardware we used with the Integrated line, door panels for both Models 427 and 427R will be applied with screws applied through our door.

The drawer panels for the Model 427R will be applied using the Integrated technique of mounting brackets.

Refer to the Overall Dimensions and Cabinetry Dimensions illustrations for Models 427 and 427R to give you a better idea of the exact space our unit needs and how the panel fits in relationship with the unit.

**IMPORTANT NOTE:** The depth of Models 427 and 427R is 24" (610) from the front of the unit to its back. You **must** allow for the thickness of the panel you are applying when planning for the finished rough opening depth if you want the front panel to be flush with surrounding cabinetry. You may have to move the unit back into the drywall or bring the cabinets forward. Refer to pages 41–47 of the Integrated section.

**IMPORTANT NOTE:** The glass door opening of the standard Models 427 and 427R is designed to be exposed to room air circulation. Decorative overlays on the glass should be kept to a minimum. While the cabinet front stiles are a minimum of 2 1/4" (57) for both Models 427 and 427R, the top and bottom rails are different.

Rails and stiles can be increased in size but should not exceed cabinet manufacturers' standard width. They cannot exceed overall door panel dimensions specified, as they would interfere with the operation of the door. The back sides of rails and stiles that will be visible through the glass door will need to be finished. Also, the inside edges of the frames must be finished to match the front surface.

### ACCESSORIES

Optional accessories are available through your Sub-Zero dealer, or call Sub-Zero at 800-222-7820. You can also visit our website at [subzero.com](http://subzero.com) and click on the accessories section for your specific model.

### CABINETRY DIMENSIONS Model 427

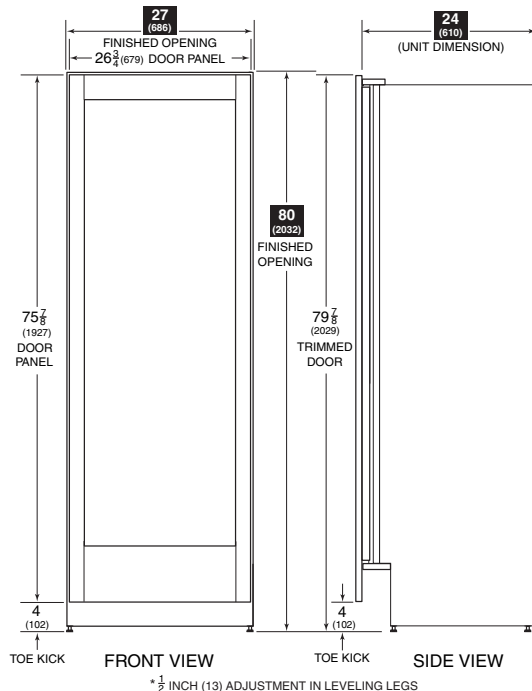

### INTEGRATED PANEL SPECIFICATIONS Model 427

Door Panel Width	<b>26 3/4" (679)</b>
Door Panel Height	<b>75 7/8" (1927)</b>
Min Width of Top Rail	<b>3 3/4" (95)</b>
Min Width of Bottom Rail	<b>8" (203)</b>
Min Width of Stiles	<b>2 1/4" (57)</b>
Door Frame Panel Weight Limit	<b>20 lbs (9 kg)</b>
Solid Door Panel Weight Limit	<b>40 lbs (18 kg)</b>
Min Panel Thickness	<b>5/8" (16)</b>

*Dimensions are in inches with millimeters in parentheses unless otherwise specified.*



**IMPORTANT NOTE:** The dimensions of these panels and stiles are assuming the models finish off at 80" (2032) in height overall and have a 4" (102) toe kick for the Model 427. If you finish off at 84" (2134), for instance, you must add 4" (102) additional to the overall height of the panel and remember to add 4" (102) to the top rail. Likewise, if you allow for a 6" (152) toe kick for the Model 427, you must subtract 2" (51) from the bottom rail.

Door panels for Models 427 and 427R can grow beyond the 80" (2032) height to accommodate any size door as long as you stay below door panel weight limit of 20 lbs (9 kg) for glass door units and 40 lbs (18 kg) for solid door units. Refer to the specifications under Door Panel Height on page 47 of the Integrated section.

**IMPORTANT NOTE:** The toe kick area on the Model 427 cannot be larger than 6" (152), and no larger than 9" (229) for the 427R.

Please note in the Overall Dimensions illustrations the location of pre-drilled holes for optional handle hardware. Refer to page 64 for specifics about installing handle hardware on this overlay application.

**IMPORTANT NOTE:** If you are installing Sub-Zero's optional lock kit on a Model 427 or 427R, you may have to order door panels that exceed the 80" (2032) finished height. Consult the lock kit installation instructions and see if your panels will allow for an adequate installation. To obtain these instructions, go to subzero.com and click on the accessories section for your specific model.

**IMPORTANT NOTE:** In the panel specifications for Model 427R, the bottom drawer panel height is based on a 4" (102) toe kick. If you want to show a 6" (152) toe kick, you must subtract 2" (51) from the bottom drawer panel height.

**IMPORTANT NOTE:** Wine Storage models with a solid door are available as a special order and require 90 days for delivery. When ordering panels for a solid door unit, follow the overall panel dimensions indicated in the chart; rail and stile dimensions do not apply.

INSTALLATION

To install integrated panels, see the detailed procedures outlined in the Sub-Zero Wine Storage Installation Guide.

**CAUTION**

A solid panel must not be installed on a glass door unit, as this may cause moisture to form behind the panel.

CABINETRY DIMENSIONS

Model 427R

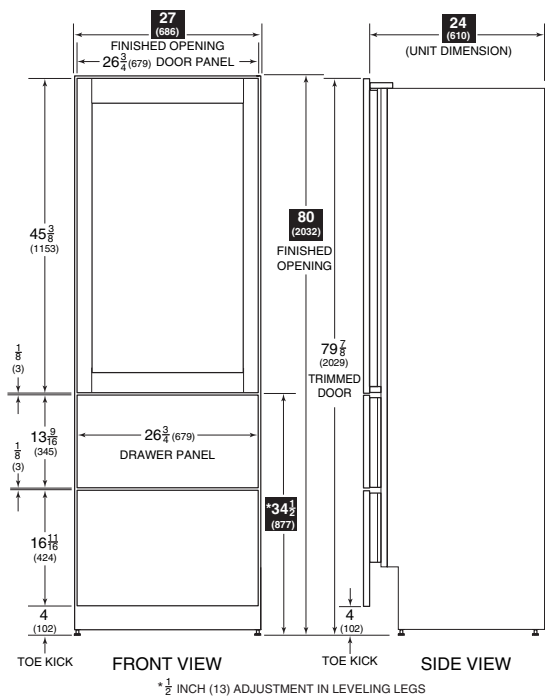

INTEGRATED PANEL SPECIFICATIONS

Model 427R

Door Panel Width	26 <sup>3</sup> / <sub>4</sub> " (679)
Door Panel Height	45 <sup>3</sup> / <sub>8</sub> " (1153)
Min Width of Top Rail	3 <sup>3</sup> / <sub>4</sub> " (95)
Min Width of Bottom Rail	3" (76)
Min Width of Stiles	2 <sup>1</sup> / <sub>4</sub> " (57)
Door Frame Panel Weight Limit	20 lbs (9 kg)
Solid Door Panel Weight Limit	40 lbs (18 kg)
Top Drawer Panel Width	26 <sup>3</sup> / <sub>4</sub> " (679)
Top Drawer Panel Height	13 <sup>9</sup> / <sub>16</sub> " (345)
Bottom Drawer Panel Width	26 <sup>3</sup> / <sub>4</sub> " (679)
Bottom Drawer Panel Height	16 <sup>11</sup> / <sub>16</sub> " (424)
Drawer Panel Weight Limit	12 lbs (5 kg) each
Min Panel Thickness	5/8" (16)



### MODEL 430 – FRAMED PANELS

You cannot use a 1/4" (6) panel to cover the glass door of a framed Model 430. It is fine when applying a panel to the solid door, but in either instance, you should consider using raised panels with a minimum 5/8" (16) thickness.

When using a raised framed panel, you must allow for the edge to be routed 1/4" (6) around the panel to ensure a proper fit. Refer to illustration 1.

With the framed Model 430, you will receive an extruded handle identical in appearance to the Built-In models. However, it will be an extended handle and will enable you to use raised panels without providing finger clearance to open the door.

**IMPORTANT NOTE:** Wine Storage models with a solid door are available as a special order and require 90 days for delivery. When ordering panels for a solid door unit, follow the overall panel dimensions indicated; rail and stile dimensions do not apply.

**⚠ CAUTION**  
A solid panel must not be installed on a glass door unit, as this may cause moisture to form behind the panel.

### MODEL 430 – OVERLAY PANELS

Your overlay model will be shipped without handle hardware and with an 11" (279) overlay panel grille as standard equipment. You will need to order a panel for the grille and hardware to complement your surrounding cabinetry.

While the overlay panel design offers you a more seamless appearance, you need to be aware of adjacent cabinets and/or countertops when the door is opened. Refer to the full-scale illustrations at the end of the Built-In section.

To achieve the overlay look, you need three different panels—the decorative overlay panel, a 0.10" (3) spacer panel and a 1/4" (6) backer panel. Depending on your cabinet manufacturer, this could be one panel routed for different dimensions or more likely, three different panels. Refer to the Overlay Panel Specifications for complete details on the overlay sizing. In addition, illustrations 2 and 3 will give you a better idea of the panel construction and how it interacts with our frame.

The glass door opening of the standard Model 430 is designed to be exposed to room air circulation. Decorative overlays on the glass should be kept to a minimum. Also, rails and stiles can be increased in size but should not exceed cabinet manufacturers' standard width. They cannot exceed overall door panel dimensions specified, as they would interfere with the operation of the door.

The back sides of rails and stiles that will be visible through the glass door will need to be finished. Also, the inside edges of the frames must be finished to match the front surface.

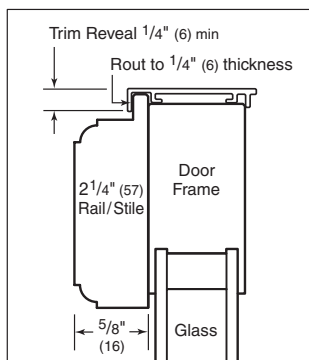

Illus. 1

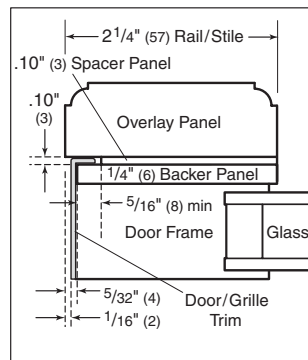

Illus. 2

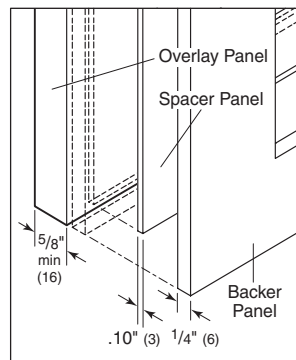

Illus. 3



As with the Sub-Zero Built-In models, you have the flexibility of ordering grilles in a variety of heights for either the framed or overlay application. Optional panel grille dimensions for the framed Model 430 are the same as listed for Built-In Models 611 and 611G on page 21.

Overlay grille panel dimensions for the overlay Model 430, standard 11" (279) grille, are listed below. Refer to page 26 for optional grille height dimensions. The width of the overlay grille, spacer and backer panel will be the same regardless of the height.

In addition, side panel information for a Model 430 is available on page 24 of the Built-In section.

**IMPORTANT NOTE:** Wine Storage models with a solid door are available as a special order and require 90 days for delivery. When ordering panels for a solid door unit, follow the overall panel dimensions indicated; rail and stile dimensions do not apply.

**⚠ CAUTION**

**A solid panel must not be installed on a glass door unit, as this may cause moisture to form behind the panel.**

INSTALLATION

To install framed or overlay panels, see the detailed procedures outlined in the Sub-Zero Wine Storage Installation Guide.

CABINETRY DIMENSIONS

Model 430



FRAMED PANEL SPECIFICATIONS

Model 430 - Framed (F)

Framed Door Panel Width	<b>28<sup>1</sup>/<sub>8</sub>" (714)</b>
Framed Door Panel Height	<b>67<sup>11</sup>/<sub>16</sub>" (1719)</b>
Min Width of Rails and Stiles	<b>2<sup>1</sup>/<sub>4</sub>" (57)</b>
Door Frame Panel Weight Limit	<b>25 lbs (11 kg)</b>
Solid Door Panel Weight Limit	<b>50 lbs (23 kg)</b>
Min Panel Thickness	<b>5/8" (16)</b>

OVERLAY PANEL SPECIFICATIONS

Model 430 - Overlay (O)

Overlay Door Panel Width	<b>28<sup>7</sup>/<sub>16</sub>" (722)</b>
Overlay Door Panel Height	<b>68" (1727)</b>
Spacer Panel Width	<b>27<sup>1</sup>/<sub>2</sub>" (699)</b>
Spacer Panel Height	<b>67<sup>1</sup>/<sub>16</sub>" (1073)</b>
Backer Panel Width	<b>28<sup>1</sup>/<sub>8</sub>" (714)</b>
Backer Panel Height	<b>67<sup>11</sup>/<sub>16</sub>" (1719)</b>
Min Width of Rails and Stiles	<b>2<sup>1</sup>/<sub>4</sub>" (57)</b>
Door Frame Panel Weight Limit	<b>25 lbs (11 kg)</b>
Solid Door Panel Weight Limit	<b>50 lbs (23 kg)</b>
Min Panel Thickness	<b>5/8" (16)</b>

GRILLE PANEL SPECIFICATIONS

Model 430 - Overlay (O)

Overlay Grille Panel Width	<b>28<sup>7</sup>/<sub>16</sub>" (722)</b>
Overlay Grille Panel Height*	<b>10<sup>1</sup>/<sub>4</sub>" (260)</b>
Spacer Panel Width	<b>27<sup>1</sup>/<sub>2</sub>" (699)</b>
Spacer Panel Height*	<b>9<sup>5</sup>/<sub>16</sub>" (236)</b>
Backer Panel Width	<b>28<sup>1</sup>/<sub>8</sub>" (714)</b>
Backer Panel Height*	<b>9<sup>15</sup>/<sub>16</sub>" (252)</b>
Grille Panel Weight Limit	<b>15 lbs (7 kg)</b>
Min Panel Thickness	<b>5/8" (16)</b>

\*Grille panel dimensions are for standard 11" (279) grille. Refer to page 25 for optional grille heights.

Dimensions are in inches with millimeters in parentheses unless otherwise specified.



## HARDWARE CONSIDERATIONS

With Models 315W and 424 (overlay), Models 427 and 427R (integrated) and the Model 430 (overlay), you must supply your own handle hardware. It is recommended you use our optional handles and use the pre-drilled holes supplied to locate the handles within the frame of our unit. This will allow you to provide the best possible handle alignment and not take away from the strength of the stile in this area after the unit is used a number of times. We recommend using a pull handle and not a pull knob.

If you elect to place different hardware on these units, we encourage you to fasten the hardware by passing through our door and attaching the hardware through the Sub-Zero door's frame.

Optional stainless steel handles are available in a variety of diameters and lengths, as are handles to match the color and style of Wolf ovens. Contact your Sub-Zero dealer for specifics.

### **▲ CAUTION**

**When planning for hardware, refer to the Door Frame Profile full-scale illustration on the following page to give you a better understanding of the unit's frame and positioning of the glass for the door. You must not drill through this glass.**

## WINE SHELF WOOD FACING

Sub-Zero has provided a natural cherry wood facing to its wine storage shelves in each model. You can also replace these strips with wood more complementary to your design and surrounding cabinetry.

The Wine Shelf Wood Facing illustration on the following page can be used as a full-scale template. You must follow the layout of this format to accommodate the shelves properly. To remove the cherry strips, take the shelves out and remove the screws. Reverse the procedure to affix the new wood.

If you choose to stain or seal the wood facing, be aware that some of these substances are hazardous and will damage stored wine.

## ACCESSORIES

Optional accessories are available through your Sub-Zero dealer, or call Sub-Zero at 800-222-7820. You can also visit our website at [subzero.com](http://subzero.com) and click on the accessories section for your specific model.

## SERVICE INFORMATION

**Sub-Zero Freezer Co., Inc.  
Customer Service Department**

**P. O. Box 44130  
Madison, WI 53744-4130**

**Service line: 800-222-7820**

**E-mail: [customerservice@subzero.com](mailto:customerservice@subzero.com)**

**Website: [subzero.com](http://subzero.com)**

*If service is necessary, contact customer service by phone or e-mail and include the model and serial number.*

*Make sure that product registration forms are filled out and returned, to assure that your information is in our database.*



**DOOR FRAME PROFILE**

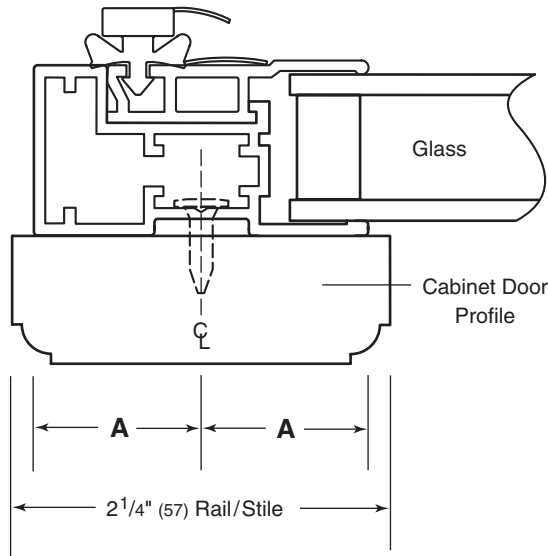

**DOOR FRAME HANDLE OFFSET**  
*Wine Storage Models*

Model	Dimension A
Model 315W	1" (25)
Model 424	1" (25)
Model 427	7/8" (22)
Model 427R	7/8" (22)
Model 430	15/16" (24)

**FULL-SCALE TEMPLATES**

The full-scale illustrations on the following pages enable you to understand some of the unique situations you may face as you plan for the installation of the Wine Storage units. Use these illustrations as templates.

**IMPORTANT NOTE:** Rails and stiles must be a minimum of 2 1/4" (57) wide (except for the rails of Models 427 and 427R, which must be wide enough to cover the door hinges). The back sides of rails and stiles that will be visible through the glass door will need to be finished.

This full-scale illustration is typical of the Model 424 door frame profile; details of the other Wine Storage door frames will vary slightly.

**WINE SHELF WOOD FACING**

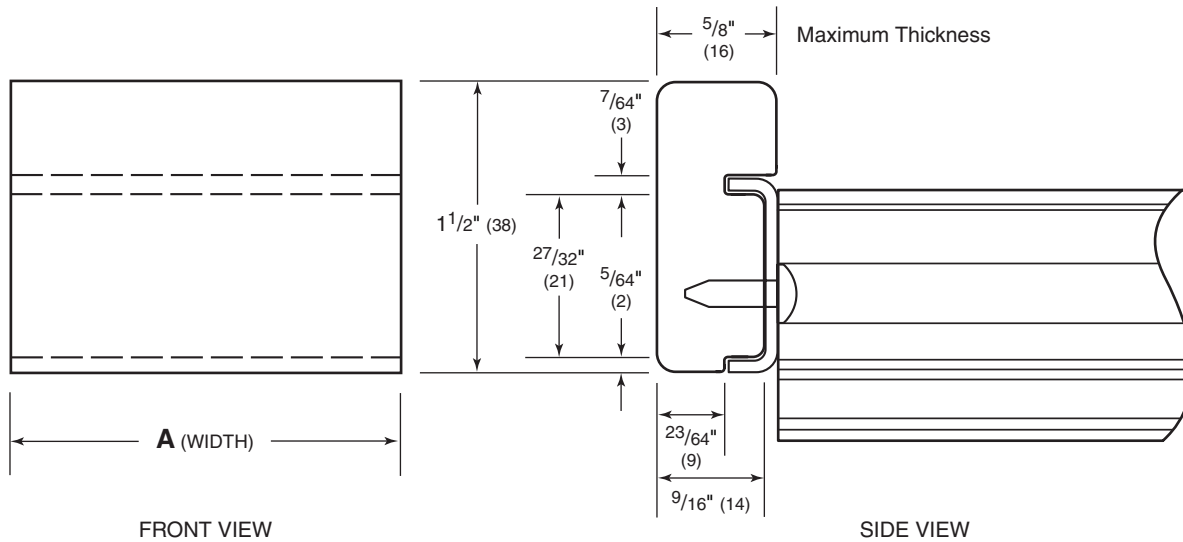

This full-scale illustration provides the dimensions you will need should you choose to replace the natural cherry wood facing of each wine shelf with wood more complementary to your design and surrounding cabinetry.

**IMPORTANT NOTE:** Dimensions will vary for Model 315W. Additional information can be found in the Specifications pdf file for Model 315W on our website at subzero.com.

**WINE SHELF WOOD FACING**  
*Wine Storage Models*

Model	Dimension A
Model 315W*	10 15/16" (278)
Model 424	19 1/2" (495)
Model 424FS	19 1/2" (495)
Model 427	20 15/16" (532)
Model 427R	20 15/16" (532)
Model 430	24 9/16" (624)

\*Dimensions will vary for Model 315W.

Dimensions in parentheses are in millimeters unless otherwise specified.



MODEL 424 - DOOR CLOSED AND 145° MAX OPENING

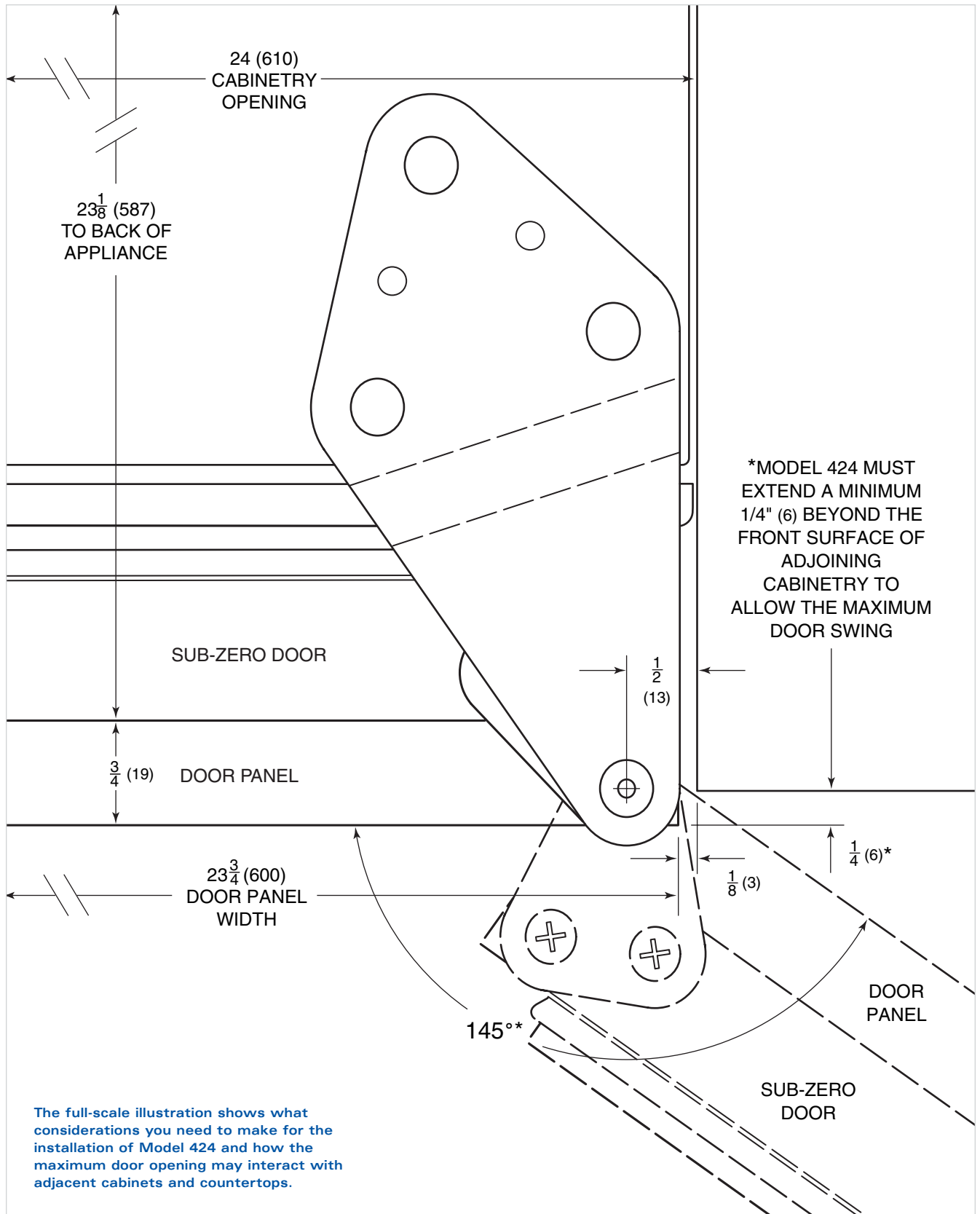



UNDERCOUNTER

## UNDERCOUNTER REFRIGERATION

Aside from the full-size models that Sub-Zero offers in its Built-In and Integrated lines of refrigeration and its Wine Storage equipment, we round out our product line-up with a line of traditional undercounter refrigeration.

Our undercounter line consists of an all refrigerator model, an all freezer model, two different refrigerator/freezer combinations and an ice maker.

The Undercounter models accept decorative door panels to fit any decor and can be built in to fit flush with virtually any base cabinet style. Optional door panels in white, almond and stainless steel are available for Models 245, 249R, 249RP and 249FF(I). A sales accessory package will enable you to apply an overlay panel on Models 249R, 249RP and 249FF(I). Optional stainless steel panels and handles for Model 315I(P) are offered in the classic, platinum and carbon stainless steel finishes. All of these optional door panels are ordered and shipped as sales accessories. Contact your Sub-Zero dealer for details. Equally important, they are all backed by one of the best warranties in the industry.

These illustrations represent the full line of Sub-Zero Undercounter models.

For information regarding specific Undercounter models, refer to the illustrations in this section.

## ALL REFRIGERATOR | ALL FREEZER

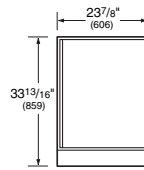

**MODEL 249RP**  
All Refrigerator  
Energy Star  
Qualified

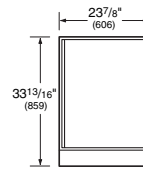

**MODEL 249FF(I)**  
All Freezer

## COMBINATION

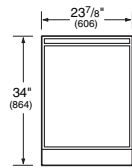

**MODEL 245**  
Combination

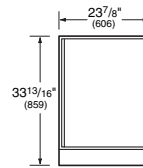

**MODEL 249R**  
Combination

## ICE MAKER

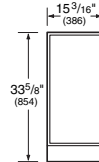

**MODEL 315I(P)**  
Ice Maker

SUB-ZERO  
WARRANTY

Sub-Zero products are covered by a two, five and twelve year residential warranty (exclusions apply). See warranty details at the end of this guide.

Comprehensive installation instructions are shipped with each model. Refer to those instructions in preparing and installing all Sub-Zero products; call Sub-Zero Freezer Company at 800-222-7820; or check our website at [subzero.com](http://subzero.com).

Dimensions are in inches with millimeters in parentheses unless otherwise specified.



UNDERCOUNTER

### MODEL 249RP

ALL REFRIGERATOR

*Energy Star Qualified*

#### SPECIFICATIONS

Overall Width	<b>23<sup>7</sup>/<sub>8</sub>" (606)</b>
Overall Height	<b>33<sup>13</sup>/<sub>16</sub>" (859)</b>
Overall Depth	<b>24" (610)</b>
Refrigerator Capacity	<b>4.9 cu ft (139 L)</b>
Min Height Required	<b>34<sup>1</sup>/<sub>4</sub>" (870)</b>
Door Swing Clearance	<b>25<sup>3</sup>/<sub>8</sub>" (645)</b>
Specify Door Swing	<b>LH or RH</b>
Annual Energy Usage	<b>333 kWh   \$28*</b>
Shipping Weight	<b>117 lbs (53 kg)</b>

#### FEATURES

- 2 Removable Shelves
- 1 Stationary Shelf
- 3 Door Shelves

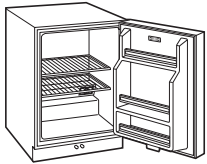

MODEL 249RP

### MODEL 249FF

ALL FREEZER

#### MODEL OPTIONS

Automatic Ice Maker **249FFI**

#### SPECIFICATIONS

Overall Width	<b>23<sup>7</sup>/<sub>8</sub>" (606)</b>
Overall Height	<b>33<sup>13</sup>/<sub>16</sub>" (859)</b>
Overall Depth	<b>24" (610)</b>
Freezer Capacity	<b>4.6 cu ft (130 L)</b>
Min Height Required	<b>34<sup>1</sup>/<sub>4</sub>" (870)</b>
Door Swing Clearance	<b>25<sup>3</sup>/<sub>8</sub>" (645)</b>
Specify Door Swing	<b>LH or RH</b>
Annual Energy Usage	<b>479 kWh   \$40*</b>
Shipping Weight	<b>135 lbs (61 kg)</b>

#### FEATURES

- 2 Removable Shelves
- 1 Stationary Shelf
- Automatic Defrost
- Automatic Ice Maker **Model 249FFI**

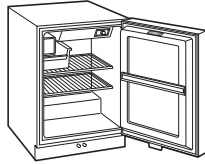

MODEL 249FF(I)

### MODEL 245

COMBINATION  
REFRIGERATOR | FREEZER

#### SPECIFICATIONS

Overall Width	<b>23<sup>7</sup>/<sub>8</sub>" (606)</b>
Overall Height	<b>34" (864)</b>
Overall Depth	<b>24" (610)</b>
Refrigerator Capacity	<b>3.0 cu ft (85 L)</b>
Freezer Capacity	<b>1.9 cu ft (54 L)</b>
Min Height Required	<b>34" (864)</b>
Door Swing Clearance	<b>25<sup>13</sup>/<sub>16</sub>" (656)</b>
Specify Door Swing	<b>LH or RH</b>
Annual Energy Usage	<b>444 kWh   \$37*</b>
Shipping Weight	<b>139 lbs (63 kg)</b>

#### FEATURES

- 2 Stationary Shelves
- 2 Door Shelves
- Automatic Defrost
- Automatic Ice Maker

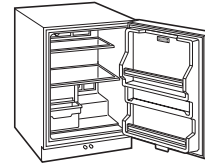

MODEL 245

*\*Annual energy costs are based on 8.29 cents per kilowatt hour.*

*\*\*Optional stainless steel panels and handles are ordered and shipped as sales accessories. For additional information on panel and handle sizes and applications, go to [subzero.com](http://subzero.com) and review the accessories section under each model for specifics.*



UNDERCOUNTER

### MODEL 249R

COMBINATION  
REFRIGERATOR | FREEZER

#### SPECIFICATIONS

Overall Width	23 <sup>7</sup> / <sub>8</sub> " (606)
Overall Height	33 <sup>13</sup> / <sub>16</sub> " (859)
Overall Depth	24" (610)
Refrigerator Capacity	4.4 cu ft (125 L)
Freezer Capacity	0.7 cu ft (20 L)
Min Height Required	34 <sup>1</sup> / <sub>4</sub> " (870)
Door Swing Clearance	25 <sup>3</sup> / <sub>8</sub> " (645)
Specify Door Swing	LH or RH
Annual Energy Usage	354 kWh   \$30*
Shipping Weight	120 lbs (54 kg)

#### FEATURES

- 2 Removable Shelves
- 1 Stationary Shelf
- 3 Door Shelves
- Manual Defrost

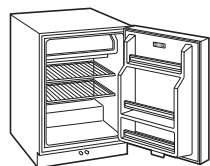

MODEL 249R

### MODEL 315I

ICE MAKER

#### MODEL OPTIONS

Drain Pump Model **315IP**

#### SPECIFICATIONS

Overall Width	15 <sup>3</sup> / <sub>16</sub> " (386)
Overall Height	33 <sup>5</sup> / <sub>8</sub> " (854)
Overall Depth	24" (610)
Ice Storage Capacity	26 lbs (12 kg)
Min Height Required	33 <sup>3</sup> / <sub>4</sub> " (857)
Door Swing Clearance	15 <sup>1</sup> / <sub>4</sub> " (387)
Shipping Weight	100 lbs (45 kg)

#### FEATURES

- Automatic Ice Maker
- Automatic Defrost
- Reversible Door Swing
- Drain Pump **Model 315IP**

#### PANEL OPTIONS

- Custom Wood Panel
- Classic, platinum or carbon stainless steel finish (includes handle)\*\*

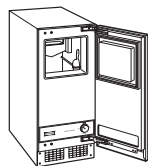

MODEL 315I(P)

#### ACCESSORIES

Optional accessories are available through your Sub-Zero dealer, or call Sub-Zero at 800-222-7820. You can also visit our website at [subzero.com](http://subzero.com) and click on the accessories section for your specific model.

#### ACCESSORIES

Contact your Sub-Zero Dealer

Door panels in white, almond and classic stainless steel

Classic stainless steel door panel with handle for Model 315I(P)\*

Conversion kit for overlay panels\*

\*Accessory is not available for every model.

Dimensions in parentheses are in millimeters unless otherwise specified.



UNDERCOUNTER

## PLANNING INFORMATION

Refer to the Installation Specifications for information regarding area requirements, minimum door clearance, electrical and plumbing placement for all Sub-Zero Undercounter models.

The Model 315I can be ordered with or without a pump. If you order the unit without a pump, you must install a drain. Refer to the Installation Specifications illustrations on the following page. The drain must be located in a 2" (51) area centered in the opening for the unit, 23" (651) back from the front door.

## PLUMBING REQUIREMENTS

For Models 245, 249FFI and 315I(P), rough in the water supply line. Connect a 1/4" OD copper line to the house supply, being sure to use an easily accessible shut-off valve between the supply and the refrigerator.

Do not use self-piercing valves. A saddle valve kit (4200880) is available from your Sub-Zero dealer. An in-line filter is required when water conditions have a high sediment content.

The ice maker operates on constant water pressure between 20 psi (1.4 bar) and 100 psi (6.9 bar).

**IMPORTANT NOTE:** In some cases, a reverse osmosis water filter system may not be able to maintain the minimum pressure consistently.

## ELECTRICAL REQUIREMENTS

A 115 V AC, 60 Hz, 15 amp circuit breaker and electrical supply are required. A separate circuit, servicing only this appliance is required.

All Undercounter models are equipped with a power supply cord with a 3-prong grounding plug, which must be plugged into a mating 3-prong grounding-type wall receptacle. Follow the National Electrical Code and local codes and ordinances when installing the receptacle. Refer to the Installation Specifications illustrations.

**IMPORTANT NOTE:** A ground fault circuit interrupter (GFCI) is not recommended and may cause interruption of operation.

## MODEL OPTIONS

**Model 249RP**  
All Refrigerator

**Model 249FF**  
All Freezer

**Model 249FFI**  
All Freezer  
with Ice Maker

**Model 245**  
Refrigerator / Freezer

**Model 249R**  
Refrigerator / Freezer

**Model 315I**  
Ice Maker

**Model 315IP**  
Ice Maker with  
Drain Pump

## INSTALLATION SPECIFICATIONS

*Undercounter Models*

### Models 249RP and 249R

- A)** Min Door Clearance **25<sup>3</sup>/<sub>8</sub>" (644)**
- B)** Location of Electrical **8<sup>1</sup>/<sub>2</sub>" (216)**
- C)** Location of Electrical **10<sup>1</sup>/<sub>2</sub>" (267)**

### Models 249FF and 249FFI

- A)** Min Door Clearance **25<sup>3</sup>/<sub>8</sub>" (644)**
- B)** Location of Electrical **2<sup>1</sup>/<sub>2</sub>" (63)**
- C)** Location of Electrical **10<sup>1</sup>/<sub>2</sub>" (267)**
- D)** Water Supply **18" (457)**

### Model 245

- A)** Min Door Clearance **25<sup>13</sup>/<sub>16</sub>" (656)**
- B)** Location of Electrical **2" (51)**
- C)** Location of Electrical **1" (25)**
- D)** Water Supply **12" (305)**

### Model 315I and 315IP

- A)** Min Door Clearance **15<sup>1</sup>/<sub>4</sub>" (387)**
- D)** Water Supply **8" (203)**

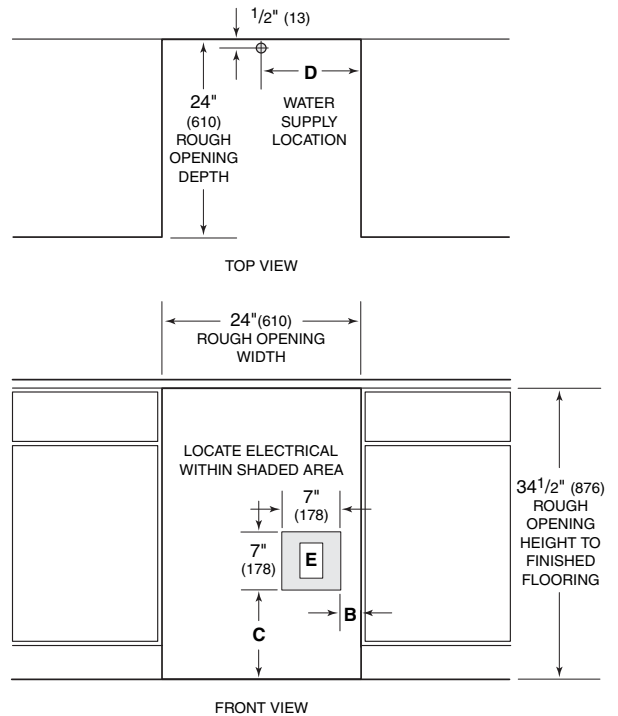
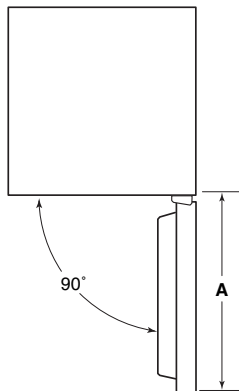

*Models without an ice maker will not require the water line connection.*

*For Model 315I(P), refer to the illustrations on page 71 for rough opening dimensions. The electrical supply can be located anywhere on the back wall.*

*Dimensions are for finished rough openings.*



UNDERCOUNTER

### MODELS 315I AND 315IP - GRAVITY DRAIN OR DRAIN PUMP

This ice maker can be ordered with a pump (Model 315IP) or without a pump (Model 315I). Models without a drain pump drain their water by gravity. However, gravity drain models may be converted to pump models through the installation of a drain pump kit and drain pump.

Specific step-by-step instructions are included with the drain pump kit. Contact your Sub-Zero dealer for specifics.

The drain and inlet water tubes must be plumbed before connecting to the ice maker. For the gravity drain, all horizontal runs of drain lines must have a 1/4" (6) per 12" (305) fall. An air gap will likely be required between the ice maker drain tube and the drain/waste receptacle. A stand pipe with a trap below it would be acceptable for the drain/waste receptacle. Refer to the illustrations below.

**IMPORTANT NOTE:** Poor drainage will cause a high rate of ice melting in the bin.

#### ACCESSORIES

Optional accessories are available through your Sub-Zero dealer, or call Sub-Zero at 800-222-7820. You can also visit our website at [subzero.com](http://subzero.com) and click on the accessories section for your specific model.

#### INSTALLATION SPECIFICATIONS

Model 315I - Gravity Drain

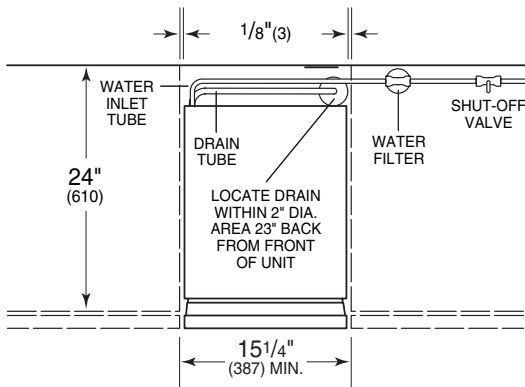

TOP VIEW

Model 315IP - Drain Pump

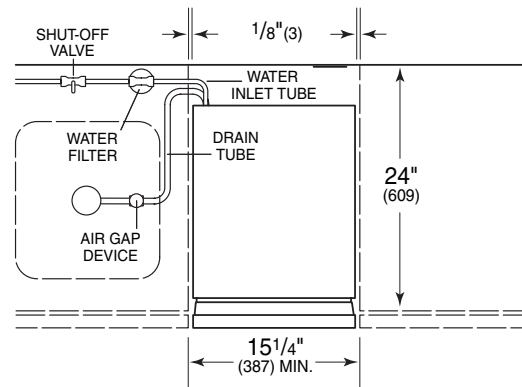

TOP VIEW

#### INSTALLATION

Refer to the installation instructions shipped with each Sub-Zero product for detailed specifications.

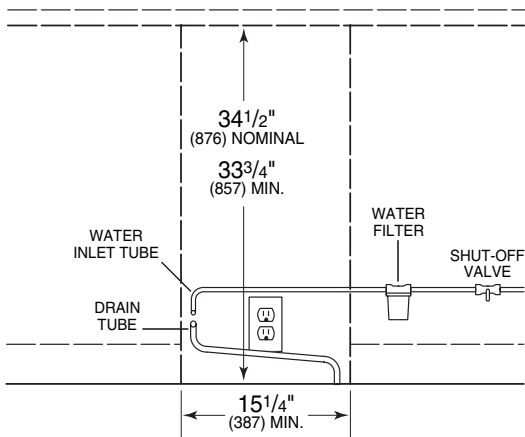

FRONT VIEW

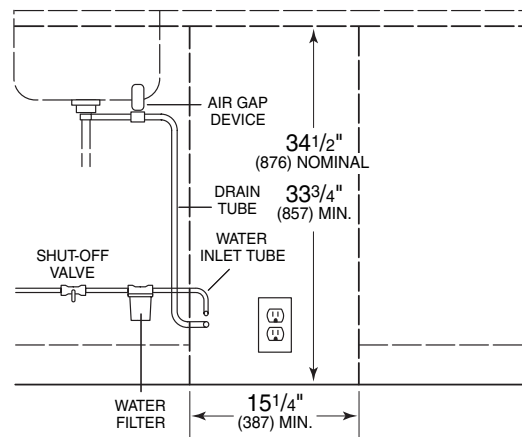

FRONT VIEW

Dimensions in parentheses are in millimeters unless otherwise specified.



### FRAMED DOOR PANELS

The framed door panel design is available for Models 249RP, 249FF(I), 245 and 249R. Framed door panels must be 1/4" (6) thick around the perimeter. If the panel is thicker than 1/4" (6), an edge must be routed around the panel to ensure a proper fit. Model 245 is the exception; while the edge must be 1/4" (6) thick, you must allow 3/8" (10) around the perimeter for the frame. See illustrations 1 and 2. The maximum door panel weight is 20 lbs (9 kg). Refer to the Framed Panel Specifications.

Illustration 3 below shows the handle recess location for framed door panels. Model 245 requires no handle recess.

**IMPORTANT NOTE:** The Model 245 lower hinge extends out from the side of the unit in the area of the kickplate. When the unit is installed tightly against a full-depth panel or cabinet, there can be interference. Refer to the full-scale illustration on page 73.

#### FRAMED PANEL SPECIFICATIONS

*Undercounter Models*

Framed Door Panel	W	H
Model 249RP	23 <sup>5</sup> / <sub>8</sub> " (600)	30" (762)
Model 249FF(I)	23 <sup>5</sup> / <sub>8</sub> " (600)	30" (762)
Model 245	23 <sup>1</sup> / <sub>2</sub> " (597)	28 <sup>1</sup> / <sub>8</sub> " (714)
Model 249R	23 <sup>5</sup> / <sub>8</sub> " (600)	30" (762)

#### OVERLAY PANEL SPECIFICATIONS

*Models 249RP, 249FF(I) and 249R*

Overlay Door Panels	W	H
Overlay Panel	24" (610)	30 <sup>5</sup> / <sub>16</sub> " (762)
Spacer Panel	23" (584)	29 <sup>3</sup> / <sub>8</sub> " (737)
Backer Panel	23 <sup>5</sup> / <sub>8</sub> " (600)	30" (762)

### OVERLAY DOOR PANELS

The overlay door panel design option is available for Models 249RP, 249FF(I) and 249R. An accessory kit (OVERPAN) is required in order to accommodate the proper installation of these overlay panels.

The overlay design allows for a decorative panel to cover the door trim for a more seamless appearance. The most common way to achieve this look is to work with three panels—the decorative 3/4" (19) thick overlay panel, a 0.10" (3) thick spacer panel and a 1/4" (6) thick backer panel. The combined weight limit of the panel assembly is 20 lbs (9 kg). Refer to the Overlay Panel Specifications.

**IMPORTANT NOTE:** An area must be notched out on the back edge of the overlay panel at both the top and bottom hinges to avoid interference as shown in illustration 4.

#### DOOR PANEL – MODEL 315I(P)

It is important to understand the differences in mounting any wood panel to the Model 315I(P). Refer to the installation instructions packaged with the unit to understand how the panel is installed. It does not require a 1/4" (6) backer. Door panel dimensions are 15" (381) wide by 30<sup>3</sup>/<sub>8</sub>" (771) high and must be a minimum of 5/8" (16) thick. The maximum door panel weight is 15 lbs (7 kg). No handle recess is required.

#### INSTALLATION

To install framed or overlay panels, see the detailed procedures outlined in the Sub-Zero Undercounter Installation Guide.

Refer to the full-scale illustrations at the end of this section for specifics on door openings and other specifications.

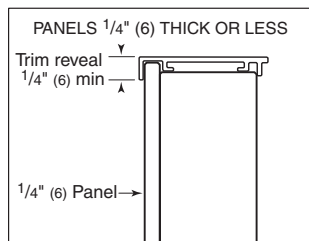

Illus. 1

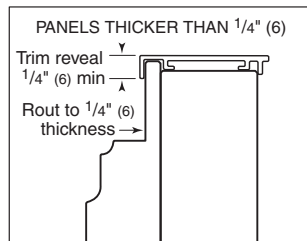

Illus. 2

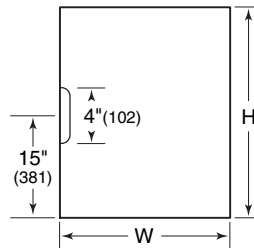

Illus. 3

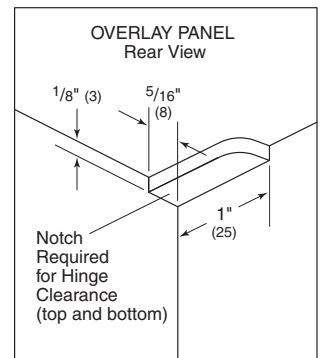

Illus. 4



MODEL 245 - LOWER HINGE

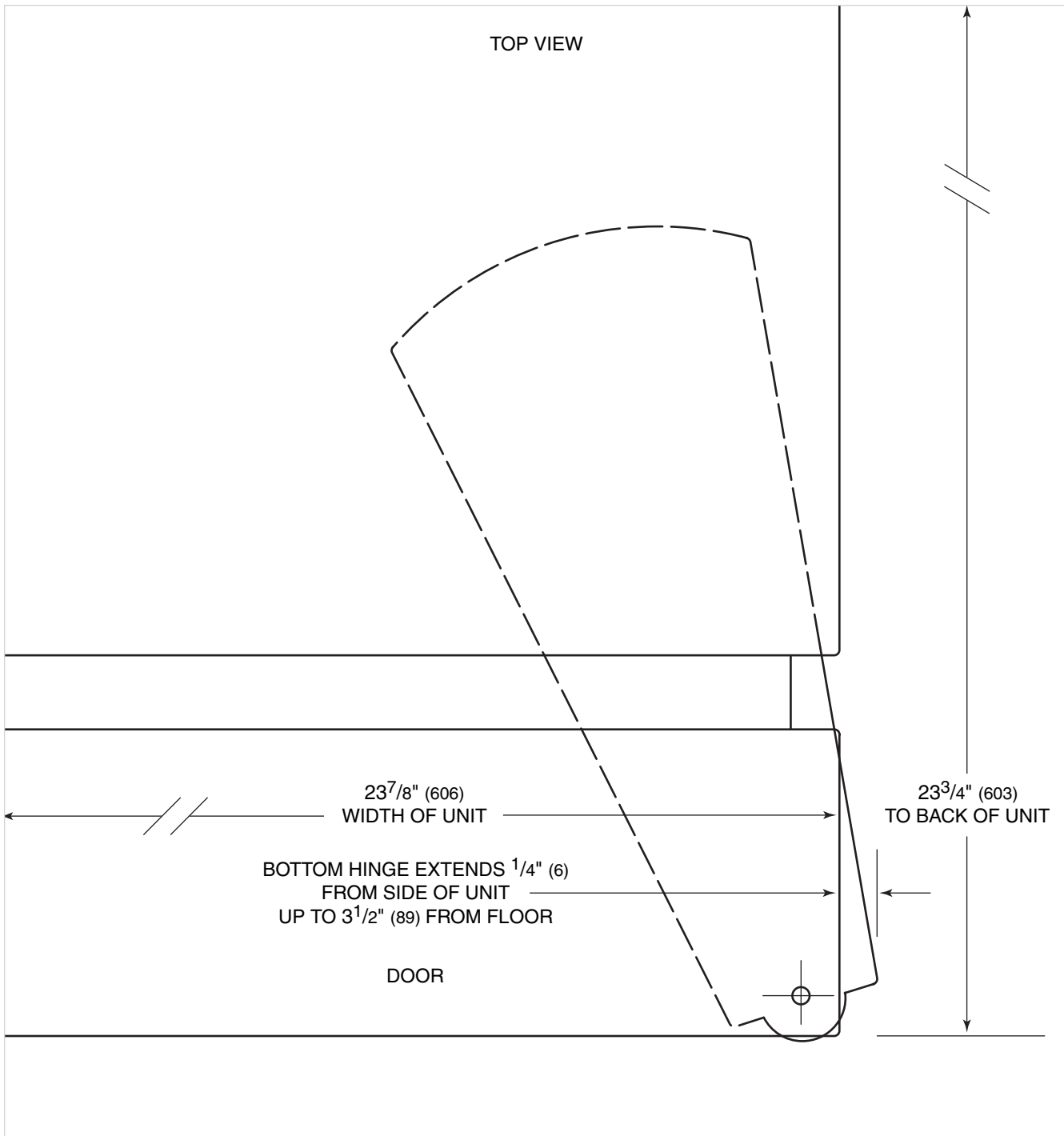

The full-scale illustration above shows how the Model 245 lower hinge extends out from the side of the unit in the area of the kickplate.

Dimensions in parentheses are in millimeters unless otherwise specified.

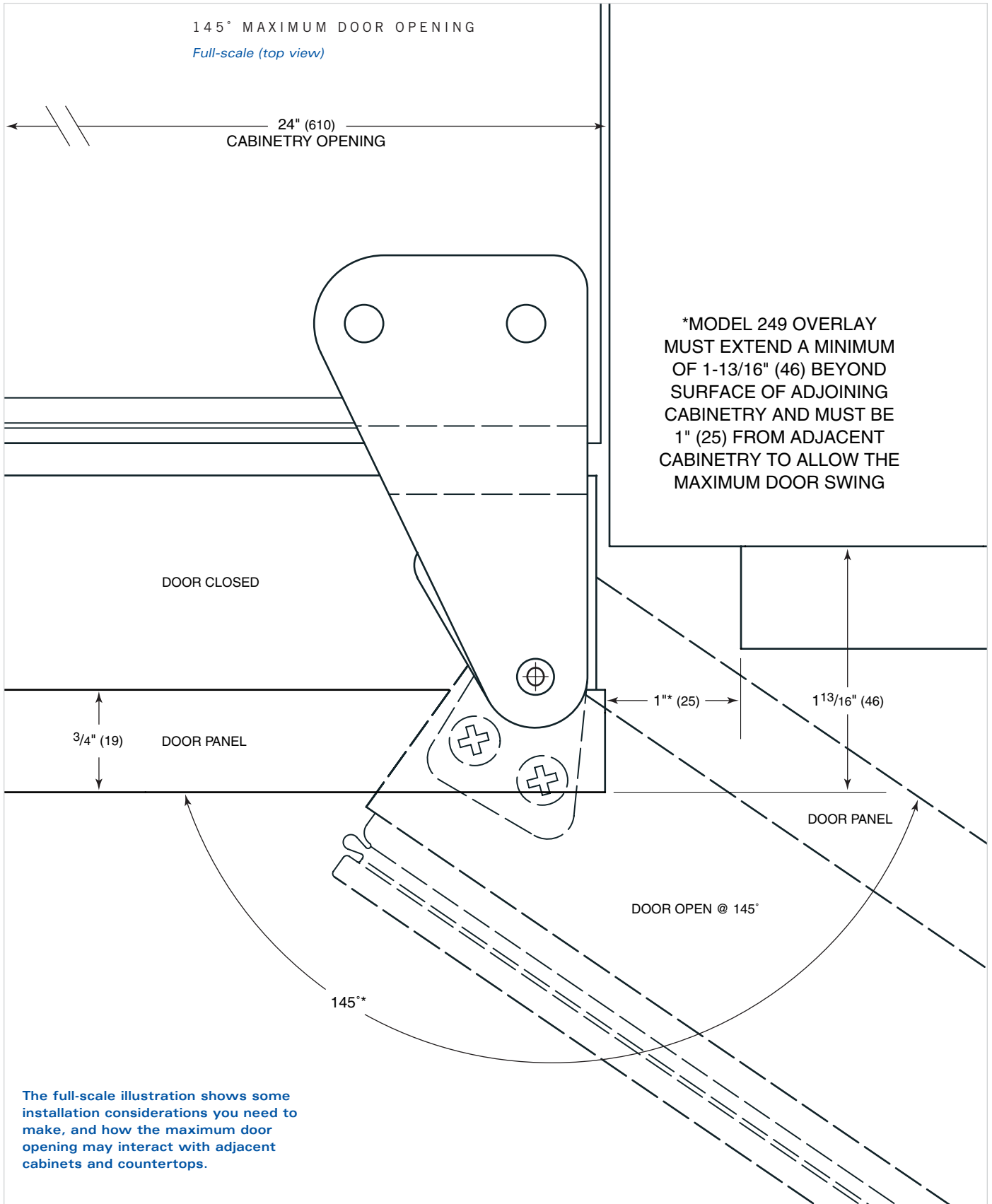

# **SUB-ZERO FREEZER COMPANY PRODUCTS LIMITED WARRANTY**

RESIDENTIAL USE ONLY

## **FULL FIVE YEAR SEALED SYSTEM WARRANTY LIMITED SIXTH THROUGH TWELFTH YEAR WARRANTY ON THE SEALED SYSTEM FULL TWO YEAR WARRANTY ON TOTAL PRODUCT\***

### **FULL FIVE YEAR SEALED SYSTEM WARRANTY**

For five years from the date of original installation, your Sub-Zero warranty covers all parts and labor to repair or replace any components that prove to be defective in materials or workmanship in the sealed system. The sealed system consists of the compressor, condenser, evaporator, drier and all connecting tubing.

### **FULL TWO YEAR WARRANTY\***

For two years from the date of original installation, your Sub-Zero warranty covers all parts and labor to repair or replace any part of the product, that proves to be defective in materials or workmanship.

### **LIMITED SIXTH THROUGH TWELFTH YEAR SEALED SYSTEM WARRANTY**

From the 6th through the 12th year from the date of original installation, your Sub-Zero warranty covers all parts that prove to be defective in materials or workmanship in the sealed system (parts only). The sealed system consists of the compressor, condenser, evaporator, drier and all connecting tubing.

### **TERMS APPLICABLE TO EACH WARRANTY**

All service provided by Sub-Zero under the above warranty must be performed by an authorized Sub-Zero service center, unless otherwise specified by Sub-Zero. Service will be provided in the home during the normal business hours. This warranty applies only to products installed for normal residential use. Details regarding a non-residential warranty are available upon request.

The warranty applies only to products installed in any one of the fifty states of the United States, the District of Columbia or the ten provinces of Canada. This warranty does not cover any parts or labor to correct any defect caused by negligence, accident or improper use, maintenance, installation, service or repair, including but not limited to improper removal and reinstallation (whether in the unit or at a remote location) of the condensing unit.

**THE REMEDIES DESCRIBED ABOVE FOR EACH WARRANTY ARE THE ONLY ONES THAT SUB-ZERO WILL PROVIDE, EITHER UNDER THESE WARRANTIES OR UNDER ANY WARRANTY ARISING BY OPERATION OF LAW. SUB-ZERO WILL NOT BE RESPONSIBLE FOR ANY CONSEQUENTIAL OR INCIDENTAL DAMAGES ARISING FROM THE BREACH OF THESE WARRANTIES OR ANY OTHER WARRANTIES, WHETHER EXPRESS, IMPLIED OR STATUTORY.**

Some states do not allow the exclusion or limitation of incidental or consequential damages, so the above limitation or exclusion may not apply to you. This warranty gives you specific legal rights and you may also have other legal rights, which vary from state to state.

To receive parts and/or service and the name of the Sub-Zero authorized service center nearest you, contact your Sub-Zero dealer, distributor or Sub-Zero Freezer Company, Customer Service Department, P.O. Box 44130, Madison Wisconsin, 53744-4130; call 800-222-7820; or e-mail us at customerservice@subzero.com.

\* Stainless Steel (classic, platinum and carbon) doors, panels, product frames and stainless interior surfaces are covered by a limited 60 day parts and labor warranty for cosmetic defects.

\* Replacement water filter cartridges are not covered by the product warranty.





SUB-ZERO FREEZER COMPANY, INC. P.O. BOX 44130 MADISON, WI 53744-4130 800-222-7820 SUBZERO.COM

