



California Faucets®

Tel: 714-891-7797
Fax: 714-891-2478
Toll Free: 800-822-8855
www.calfaucets.com

ACCESSORIES

INSTALLATION INSTRUCTIONS

Dual Post Items (For dimensions on center see Fig. 9)

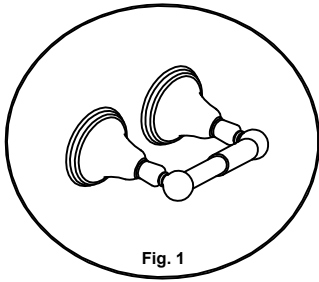

Toilet Paper Holder

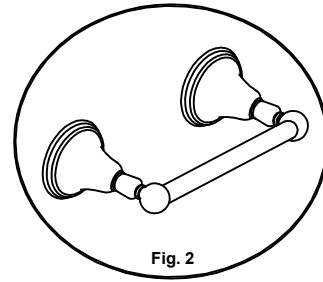

Towel Bar

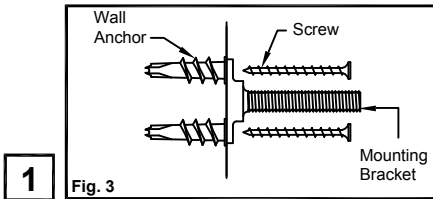

1 Fig. 3
Install mounting brackets to wall with screws (supplied) and anchors (if applicable). (See Fig. 9 for proper centering).

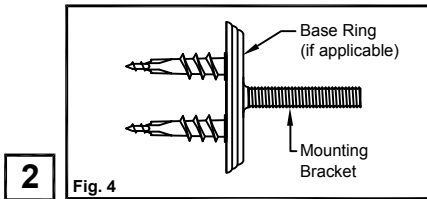

2 Fig. 4
Place base rings (required on certain models) against wall, over the mounting brackets.

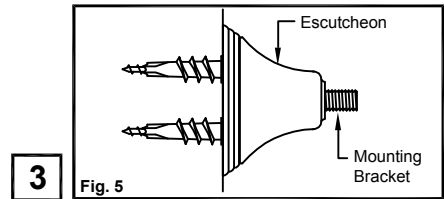

3 Fig. 5
Place escutcheons against wall, over the mounting brackets.

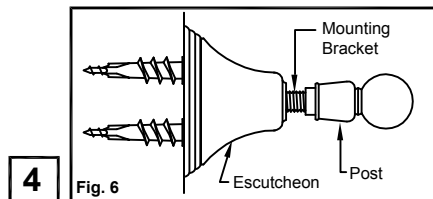

4 Fig. 6
Set posts over the mounting brackets, inserting through escutcheons.

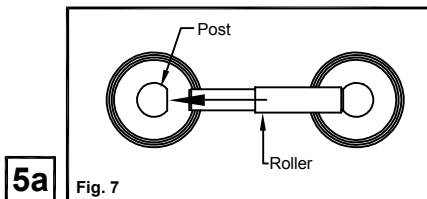

5a Fig. 7
For toilet paper holder, align posts and tighten set screws with allen key (supplied). Then simply insert roller into posts.

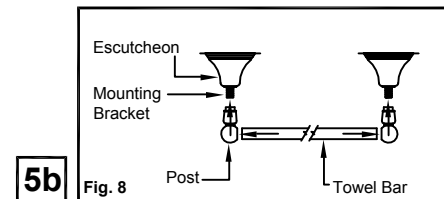

5b Fig. 8
Insert towel bar into both posts and slide both posts onto the mounting bracket posts protruding from escutcheons. Then tighten both set screws from below.

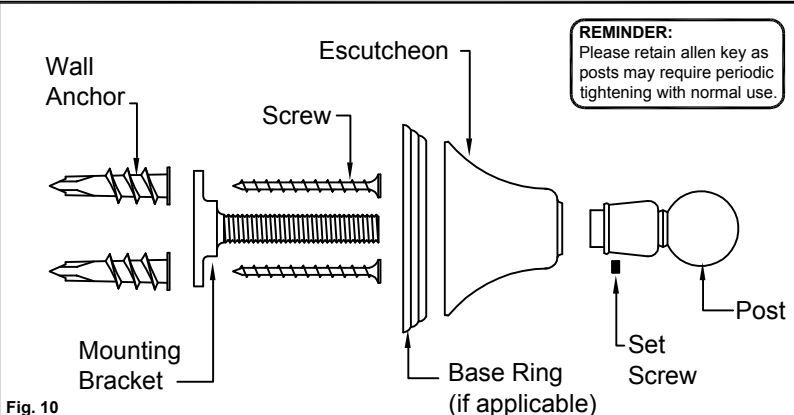
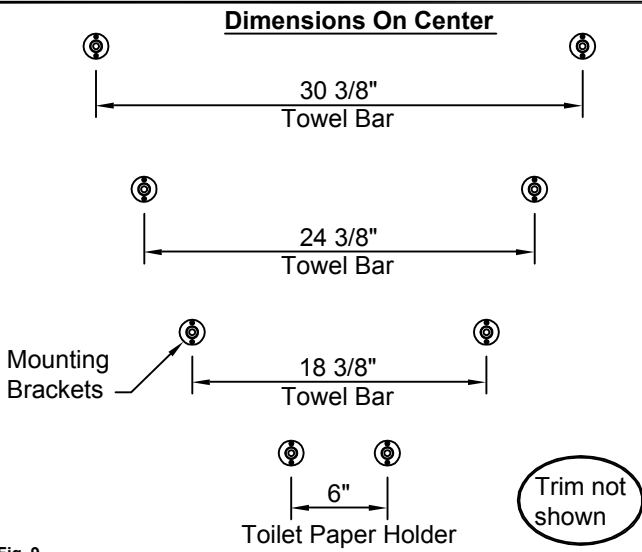

REMINDER:
Please retain allen key as posts may require periodic tightening with normal use.

IMPORTANT CLEANING NOTICE
Please refer to *Finish Care Instructions* for complete cleaning information. Wipe frequently with a soft, damp cloth. *Never use acids, harsh abrasives or detergents.*



Tel: 714-891-7797
 Fax: 714-891-2478
 Toll Free: 800-822-8855
 www.calfaucets.com

ACCESSORIES

**INSTALLATION
INSTRUCTIONS**

California Faucets®

IMPORTANT

All California Faucets® products are engineered to provide quality performance provided they are installed and operated properly. To fully enjoy the comfort, safety, and reliability of your new Accessories, please follow the instructions below.

California Faucets reserves the right to make modification and specification changes at any time. Please visit www.calfaucets.com for most current technical data.

Single Post Items

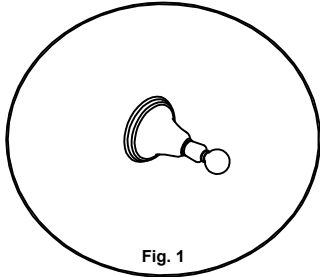

Robe Hook

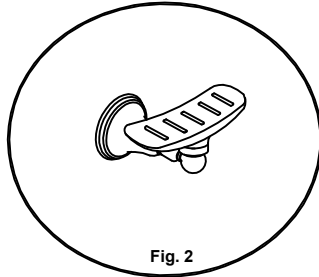

Soap Dish

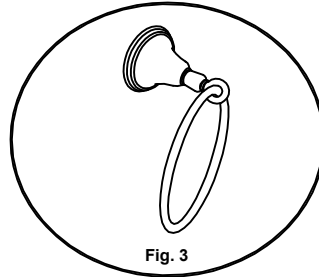

Towel Ring

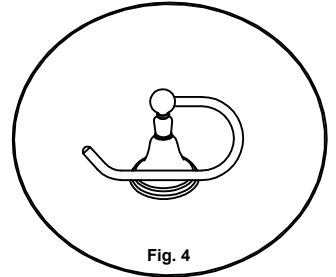

Paper/Towel Holder

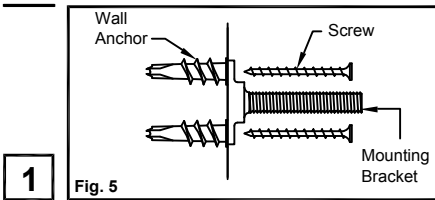

Install mounting bracket to wall with screws (supplied) and anchors (if applicable).

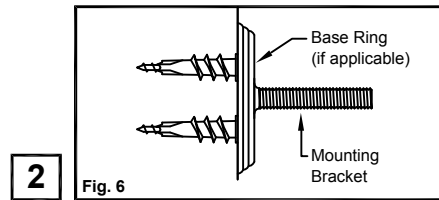

Place base ring (required on certain models) against wall, over the mounting bracket.

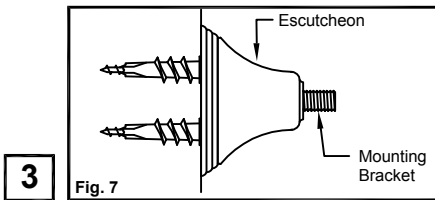

Place escutcheon against wall, over the mounting bracket.

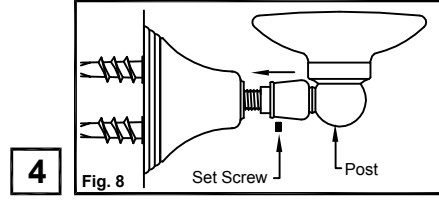

Set post over the wall bracket, inserting through escutcheon. Tighten set screw with allen key (supplied).

REMINDER:
Please retain allen key as posts may require periodic tightening with normal use.

