



Read and Save These Instructions

All Hoods Must Be Installed By A Qualified Installer

INSTALLATION INSTRUCTIONS SLH6-K UNDER CABINET HOOD

Read All Instructions Thoroughly Before Beginning Installation

**WARNING - TO REDUCE THE RISK OF FIRE, ELECTRIC SHOCK,
OR INJURY TO PERSONS, OBSERVE THE FOLLOWING:**

- A. Installation work and electrical wiring must be done by qualified person(s) in accordance with all applicable codes and standards, including fire-rated construction. Switch power off at service panel and lock the service disconnecting means to prevent power from being switched on accidentally during installation.**
- B. When cutting or drilling into wall or ceiling, do not damage electrical wiring and other hidden utilities.**
- C. Ducted fans must always be vented to the outdoors.**
- D. Sufficient air is needed for proper combustion and exhausting of gases through the flue (chimney) of fuel burning equipment to prevent back drafting. Follow the heating equipment manufacturer's guideline and safety standards such as those published by the National Fire Protection Association (NFPA), and the American Society for Heating, Refrigeration and Air Conditioning Engineers (ASHRAE), and local code authorities.**

**WARNING - TO REDUCE THE RISK OF FIRE, USE ONLY METAL
DUCTWORK**

Vent-A-Hood®

Ducting Do's and Don'ts

NEVER restrict the duct size. The K250 blower unit requires 7" round duct or equivalent (32.5 square inches). Using Vent-A-Hood transitions (back page) will ensure proper efficiency.

Blower	Duct Size	Sq. Inch Area
K250	3 1/4" x 10" rectangular or equivalent	32.5"

Do not use flexible or corrugated duct. This type of duct will restrict airflow and reduce performance. Only use smooth, galvanized, metal duct. Observe local codes regarding special duct requirements and placement of duct against combustibles. Make the duct run as short and as straight as possible with as few turns as possible. Avoid sharp-angled turns. Instead, use smooth, gradual turns such as adjustable elbows or 45 degree angled turns. For duct runs over 20 feet, increase the duct diameter by one inch for every ten feet of duct. A 90 degree elbow is equal to 5 feet of duct. Using Vent-A-Hood roof jacks or wall louvers (back page) will ensure proper efficiency. Airflow must not be restricted at the end of the duct run. Do not use screen wire or spring-loaded doors on wall louvers or roof jacks. Do not terminate venting into an attic or chimney. Where possible, seal joints with duct tape. The hood must be ducted to the outdoors without restrictions.

YES



Smooth Duct

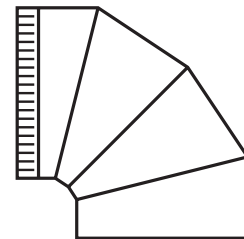

Smooth Gradual Turn

NO

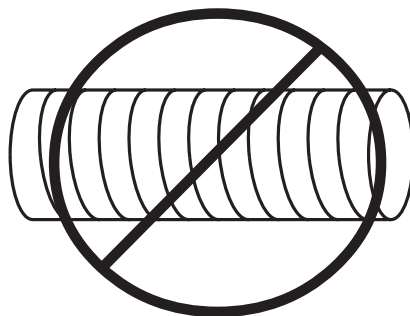

Flexible Duct

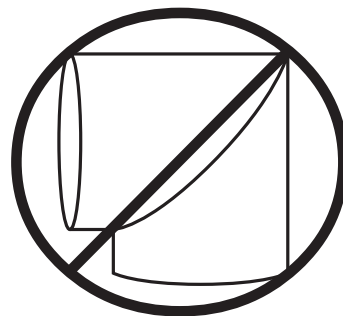

Sharp Angled Turns

Vent-A-Hood®

Installation Details

- 1) Read all instructions thoroughly before beginning installation.
- 2) When installing the SLH6-K under cabinet hood, it is recommended that the bottom edge of the hood be located no more than 21" - 24" from the cooking surface. Exceeding recommended mounting height may compromise performance.

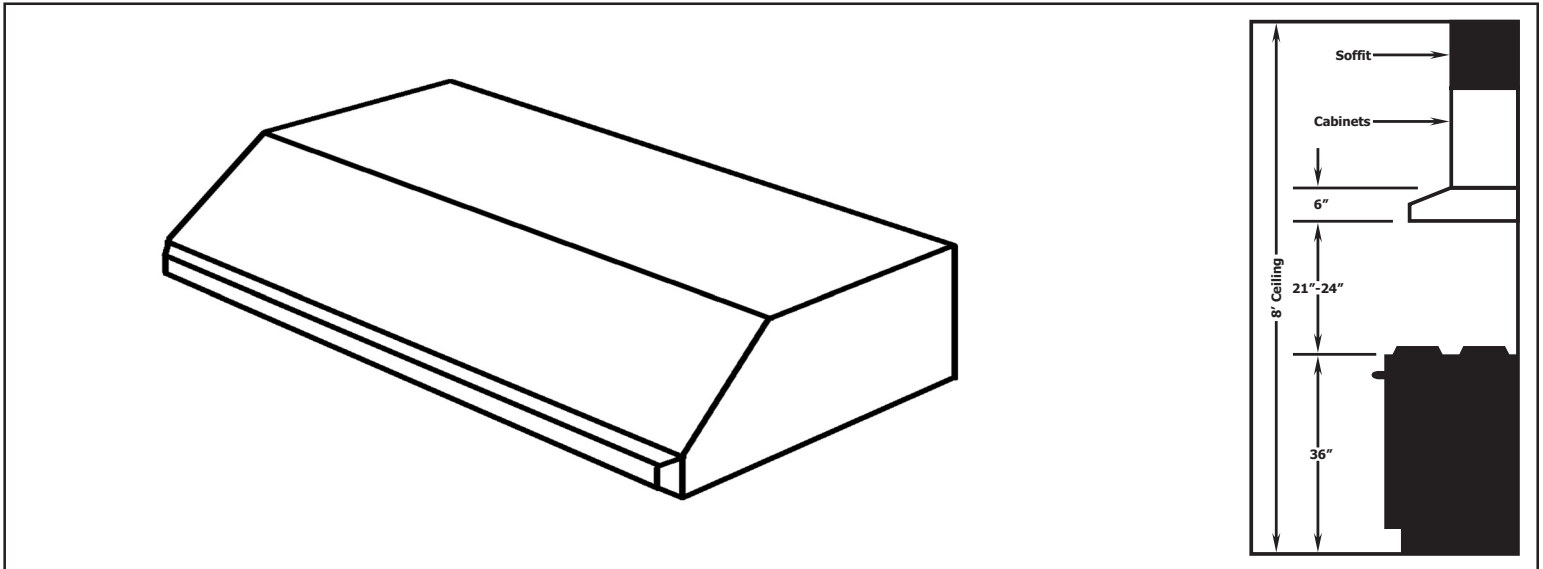

- 3) Inspect the underside of the cabinet for a flush mounting surface. If the underside of the cabinet is recessed, install wood strips to provide a flush surface for the hood mounting screws to engage.
- 4) Determine whether the hood will discharge horizontally or vertically. The hood is shipped to discharge vertically but is easily converted to horizontal discharge by exchanging the discharge adapter on top of the hood (4 screws) with the discharge cover on the back of the hood (2 screws). Use duct tape to seal the discharge adapter and discharge cover to the hood.
- 5) IF THE HOOD IS TO BE "BACK VENTED", PROCEED DIRECTLY TO STEP 6.

Install the duct from the outside of the home down to the location of the hood exhaust outlet allowing room for the VP521 transition on the top of the hood (if applicable). If a VP521 transition is used, install the duct down to the location of the transition outlet plus 1". This will allow the transition to engage 1" inside of the duct. Consult the connection diagram (below) for further details on exhaust outlet placement.

Use duct tape to seal all joints. A complete listing of available Vent-A-Hood ducting materials is provided on the back page of this instruction sheet.

Transition height: 3 1/4" x 10" duct will connect directly to the exhaust outlet of the hood. Optional VP521 transition to 7" round (sold separately) is 7 1/2" tall.

Ceiling Cutout for Vertical Ducting

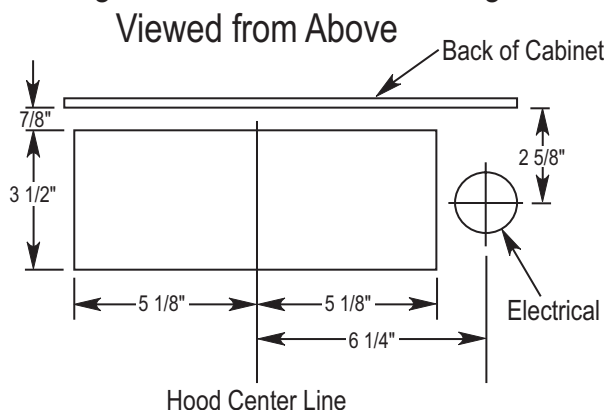

Vent Hood®

Installation Details Continued

- 6) Remove the hood from its packaging and place on the floor or countertop in front of the cabinet where it will hang.

Warning: Make sure power is off and locked at the service disconnecting means on the service panel during installation.

- 7) Determine whether the electrical wire will enter from the top or the back of the hood. Remove the electrical enclosure cover (1 screw) and the top or back electrical enclosure knockout from the hood. Install an appropriate 1/2" UL listed electrical wire clamp through the electrical knockout. Install electrical wiring from the electrical panel to the hood location.

Model	Volts	Amps	RPM	CFM SP@0.0"	Equivalent CFM#	CFM SP@0.1"	CFM SP@0.2"	CFM SP@0.3"	Minimum Round Duct Size	Square Inches
K250 (Top Vent - High)	115	3.2	1550	240	360	225	215	200	7" (or equivalent)	38
K250 (Top Vent - Low)	115	3.2	1200	170	255	170	160	155	7" (or equivalent)	38
K250 (Back Vent - High)	115	3.2	1550	220	330	215	195	180	7" (or equivalent)	38
K250 (Back Vent - Low)	115	3.2	1200	175	265	170	160	145	7" (or equivalent)	38

#Because the Magic Lung™ uses centrifugal filtration rather than conventional baffle or mesh filters, the Magic Lung™ blower can handle cooking equipment with higher cubic feet per minute (CFM) requirements and can deliver equivalent CFM much more efficiently than other than other filtration systems. When comparing the Magic Lung™ with other blower units made by other manufacturers, use the "Equivalent CFM".

- 8) Insert the electrical wire through the electrical wire clamp allowing 3" - 4" of wire inside the enclosure for hookup. Tighten the electrical wire clamp.
- 9) From inside the hood, using UL listed wire nuts, attach the "neutral" wire to the white lead, the "hot" wire to the black lead, and the ground wire to the green lead inside the junction box. Replace the electrical cover previously removed in Step 7.

Warning: Do not operate hood without proper ground connection.

- 10) FOR BACK VENTING APPLICATIONS ONLY. IF YOU ARE NOT BACK VENTING, PROCEED DIRECTLY TO STEP 12.

Note: Wall studs may interfere with back venting installations. Additional framing may be required. It is necessary to cut a duct access hole in the wall prior to installing the hood. Starting 2 1/8" above the bottom edge of the hood, cut a hole 3 1/2" high x 10 1/4" wide (see diagram at right).

- 11) Install the duct from the outside of the home to the duct access hole in the wall. Where possible, use duct tape to seal joints.
- 12) While aligning the duct and guiding the wires, position the hood under the cabinet. The duct should connect together as the hood is located in place. **Note:** Unless using the VP521 transition, the duct work must fit inside the exhaust collar. If using the VP521, 7" round duct should be placed with the non-crimped end on the outside of the collar of the VP521 exhaust outlet. Using the four screws provided, attach the hood to the bottom of the cabinet.

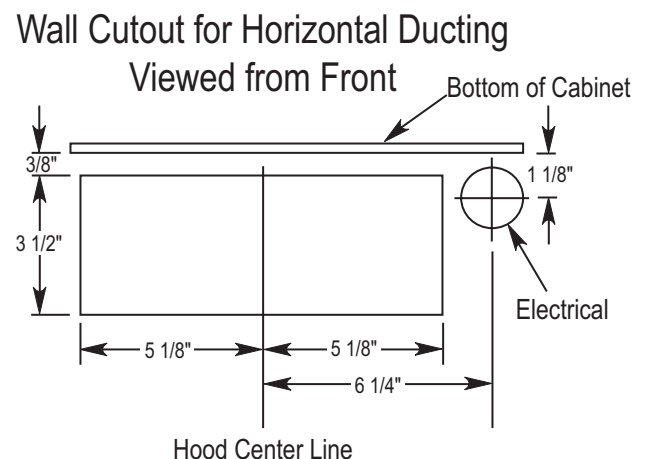

- 14) Refer to the Owner Maintenance Guide Operating Instructions for proper hood operation. Test all blower and light functions to ensure they are operating properly.

VENTING *Vent-A-Hood*® ACCESSORIES

WALL LOUVER

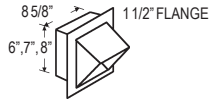

MODEL	DIM
VP526	6" RD
VP527	7" RD
VP528	8" RD
VP538	6"x8 1/2"

WALL LOUVER

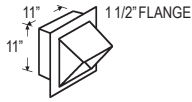

MODEL	DIM
VP554	10" RD

WALL LOUVER

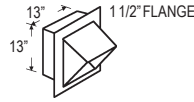

MODEL	DIM
VP555	12" RD

WALL LOUVER

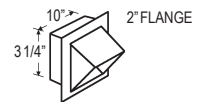

MODEL	DIM
VP560	3 1/4"x10"

LOW PROFILE ROOF JACK (MAXIMUM 4/12 PITCH)

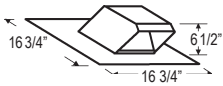

MODEL	DIM
VP539	6"
VP540	7"
VP541	8"

LOW PROFILE ROOF JACK (MAXIMUM 4/12 PITCH)

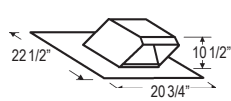

MODEL	DIM
VP552	10"
VP553	12"

ADJUSTABLE ELBOW

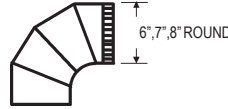

MODEL	DIM
VP513	6"
VP514	7"
VP515	8"

BACK/SIDE VENT ELBOW

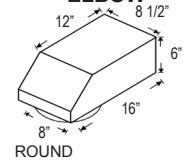

MODEL	DIM
VP561	8" - 6" x 8 1/2"

BACK VENT ELBOW

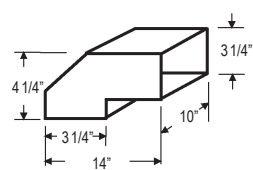

MODEL	DIM
VP559	3 1/4"x10"

MULTI-BLOWER TRANSITION

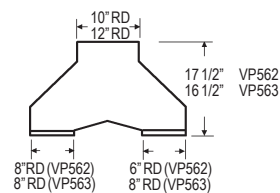

MODEL	DIM
VP562	10"
VP563	12"

"Y" TRANSITION

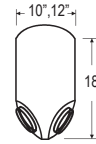

MODEL	DIM
VP517	8" x 8" - 12"
VP518	6" x 8" - 12"
VP551	6" x 8" - 10"

10 TO 7 TRANSITION

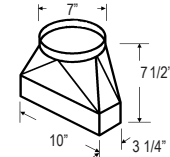

MODEL	DIM
VP521	3 1/4" x 10" - 7"

OFFSET KIT-ROUND

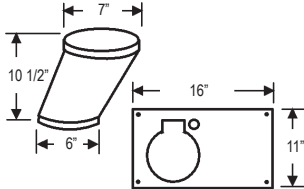

MODEL	DIM
VP529	6" TO 7"

OFFSET KIT-RECTANGLE

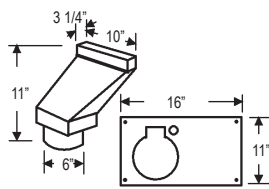

MODEL	DIM
VP550	6"-3 1/4"x10"

STANDARD ISLAND TRANSITION

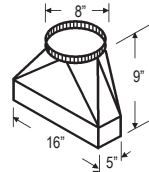

MODEL	DIM
VP565	

CLUSTER BLOWER TRANSITION

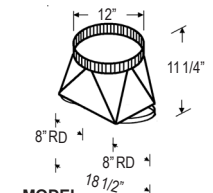

MODEL	DIM
VP564	

OFFSET L & R TRANSITION FOR ISLAND BLOWERS

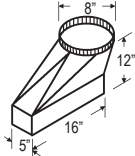

MODEL	DIM
VP542	TOP LEFT ISLAND
VP543	TOP RIGHT ISLAND

SIDE VENT TRANSITION L & R FOR ISLAND HOODS

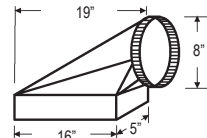

MODEL	DIM
VP544	LEFT SIDE
VP545	RIGHT SIDE

ROUND COLLAR

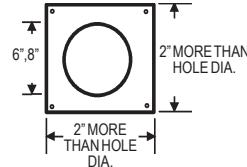

MODEL	DIM
VP533	6"
VP535	8"

COLLAR, SQUARE

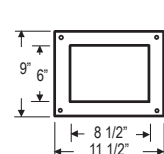

MODEL	DIM
VP537	6 x 8 1/2"

ROUND DUCT

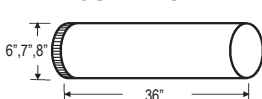

MODEL	DIM
VP500	6"
VP501	7"
VP502	8"

3 1/4" RECTANGLE DUCT

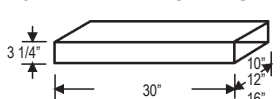

MODEL	DIM
VP504	3 1/4" x 10"
VP505	3 1/4" x 12"
VP506	3 1/4" x 16"

6" RECTANGLE DUCT

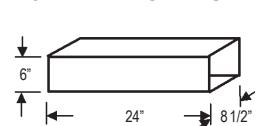

MODEL	DIM
VP507	6" x 8 1/2"