

This Data Sheet Includes Information On

Marvel

- Product Model Number (s):
Chateau Collection Wine Cellar:
8SWCE-WW-G, 8SWCE-BB-G and 8SWCE-BS-G

Dimensions (Actual Size)

- Overall depth including handle: 26 1/4"
- Overall depth NOT including handle: 24 1/4"
- Depth NOT including door: 22"
- Height at full leg adjustment: 35"
- Height at 0" leg adjustment: 34 1/4"
- Height without legs installed: 34"
- Width: 23 7/8"
- Toe Kick height: 3"
- Door swing at 90°: 31 1/2"
- Recommended opening width: 30"
- Recommended opening depth: 24"
- Recommended opening height: 34 1/2"

Additional Information

- Electrical requirements: 120 volts, 3 amps running max. 15 amp circuit required.
- Locate a 3-prong grounded receptacle in one of three locations: 1) On the wall in the adjacent cabinet opening. 2) Flush on the back wall of the refrigerator opening (add 1" to the overall depth of the unit to accommodate the thickness of the plug). 3) Recessed 1" into the back wall of the refrigerator opening.
- Door is reversible in field if model does NOT include -LL or -LR.
- Door lock (when -LL, left hand hinge or -LR, right hand hinge is added to the model number), top center of door. Door with lock is not field reversible.
- Wine racks may be fully extended at 90° door opening.
- Shipping weight: 172 pounds.
- U.L. Listed.
- Full wrap door with designer full-length bar handle.
- Does not accept custom panels.

See page 2 for additional information

Subject to change without notice. This system is designed to be updated daily if necessary. Dimension Express is not responsible for use of superseded, voided, or outdated data sheets. Because of the difficulty or impracticability of determining actual damages, liability of Dimension Express shall not exceed \$50.00.

Copyright © Dimension Express, 2007.

318

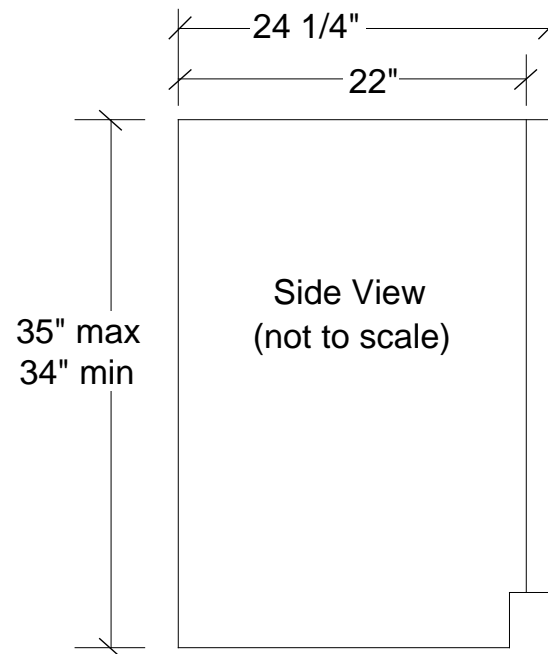
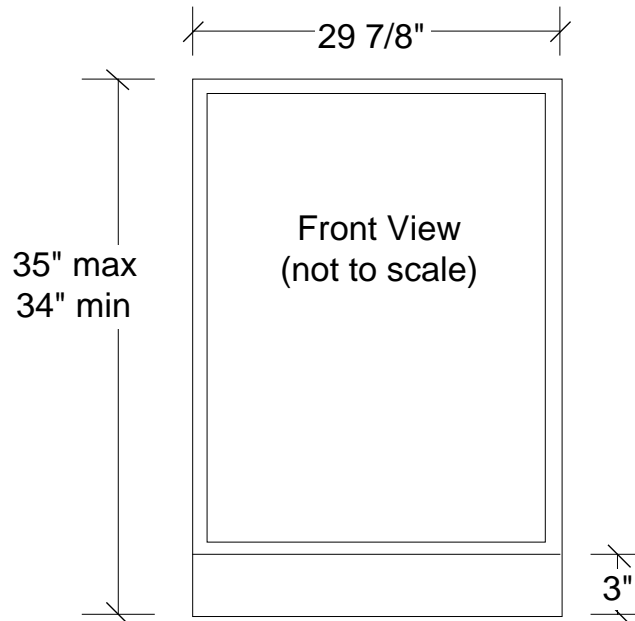

• NEVER reuse Data Sheets. Data Sheets are subject to change without notice. Dimension Express is a FREE service bureau and is updated daily, it makes far more sense to spend the time necessary to request new Data Sheets for each project, as opposed to the problems, time, costs, and risks associated with reusing old Data Sheets.

- Call Dimension Express if you have any questions at (800) 940-2059 •
- Always refer to a current Code at a Glance or manufacturer directory •
- Data Sheet codes change on the first of each quarter at 12:01am •

BN • A318B149 • •071004 • 115720 • 32958

Chateau Collection Wine Cellar:
8SWCE-WW-G, 8SWCE-BB-G and 8SWCE-BS-G

Additional Information:

- 8SWCE-WW-G : White cabinet, white frame glass door, high gloss white interior. Shelf fronts are clear, solid maple (unfinished).
- 8SWCE-BB-G : Black cabinet, black frame glass door, high gloss ebony interior. Shelf fronts are clear, solid maple (unfinished).
- 8SWCE-BS-G : Black cabinet, stainless finish frame glass door, high gloss ebony interior. Shelf fronts are clear, solid maple (unfinished).

Accessories:

- Casters: P/N 42244041.
- Marvel Shelf Front Kits: Prefinished shelf fronts (6) and wine cradle rack (1).
- Gloss black: P/N 42245244
- Gloss white: P/N 42245245
- Stainless steel: P/N 42245246
- Natural maple (unfinished): P/N 42245243

Subject to change without notice. This system is designed to be updated daily if necessary. Dimension Express is not responsible for use of superseded, voided, or outdated data sheets. Because of the difficulty or impracticability of determining actual damages, liability of Dimension Express shall not exceed \$50.00. Copyright © Dimension Express, 2007.

• NEVER reuse Data Sheets. Data Sheets are subject to change without notice. Dimension Express is a FREE service bureau and is updated daily, it makes far more sense to spend the time necessary to request new Data Sheets for each project, as opposed to the problems, time, costs, and risks associated with reusing old Data Sheets.

- Call Dimension Express if you have any questions at (800) 940-2059 •
- Always refer to a current Code at a Glance or manufacturer directory •
- Data Sheet codes change on the first of each quarter at 12:01am •