

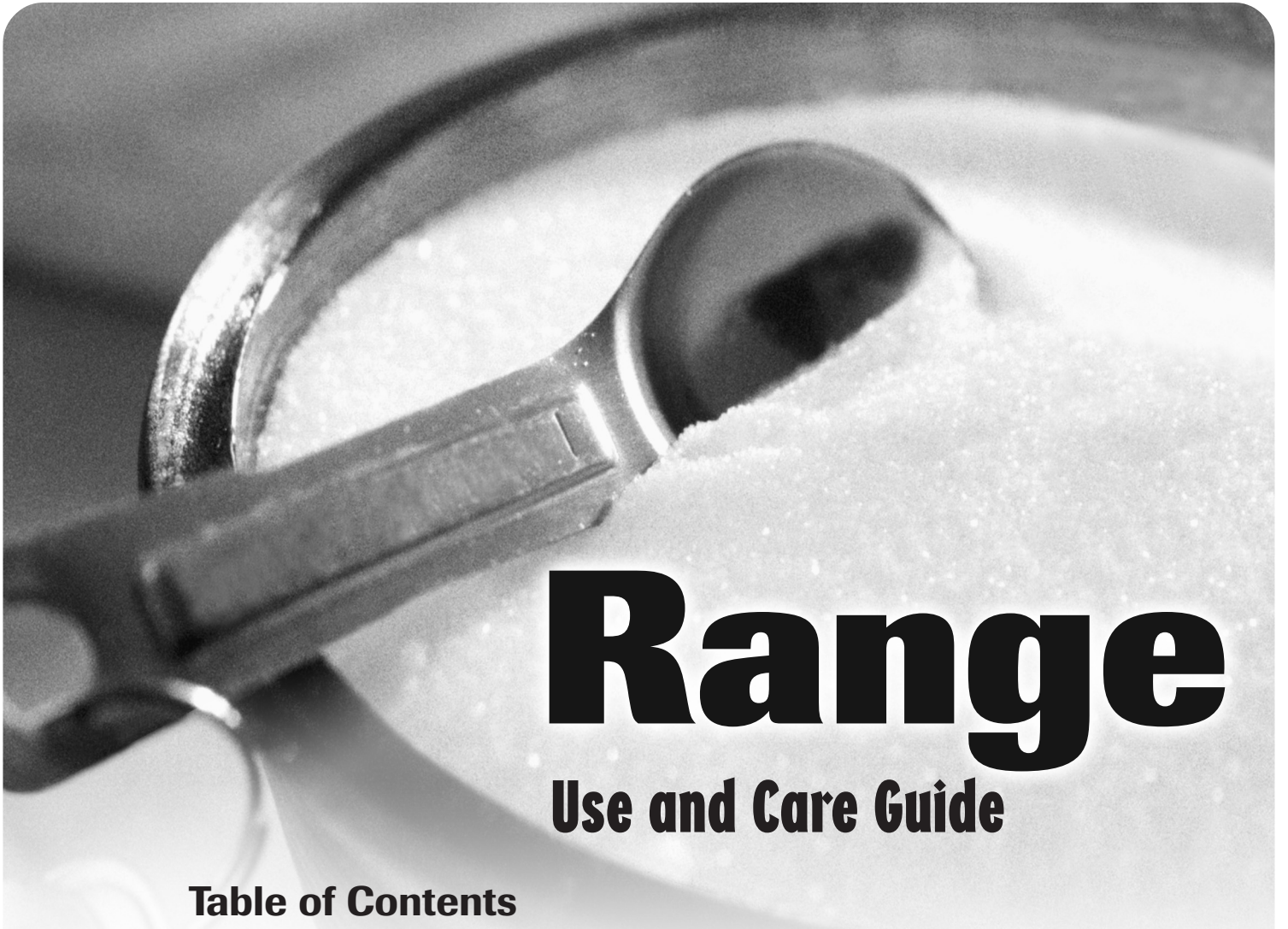

Electric Smoothtop and Electric Coil Double Oven Range Precision Touch 500 Series



Range

Use and Care Guide

Table of Contents



**Important Safety
Instructions** 1-4



Surface Cooking 5-7
Controls
Coil Elements
Smoothtop Surface



Oven Cooking 8-15
Upper Oven Control (Manual Clean)
Lower Oven Control (Self-Clean)
Baking
Cook & Hold
Delay Bake
Keep Warm
Broiling (Lower Oven Only)
Oven Racks



Care & Cleaning 16-19
Self-Clean Oven (Lower Oven Only)
Cleaning Procedures



Maintenance 20
Oven Doors and Windows
Oven Lights



Troubleshooting 21-22



Warranty & Service Back Page

Installer: Please leave this guide with this appliance.

Consumer: Please read and keep this guide for future reference. Keep sales receipt and/or canceled check as proof of purchase.

Model Number _____

Serial Number _____

Date of Purchase _____

If you have questions, call:

Customer Assistance

1-800-688-9900 USA

1-800-688-2002 Canada

1-800-688-2080 (U.S. TTY for hearing or speech impaired)

(Mon.-Fri., 8 am-8 pm Eastern Time)

Internet: <http://www.maytag.com>

In our continuing effort to improve the quality and performance of our cooking products, it may be necessary to make changes to the appliance without revising this guide.

For service information, see back page.



Important Safety Instructions

Warning and Important Safety Instructions appearing in this guide are not meant to cover all possible conditions and situations that may occur. Common sense, caution, and care must be exercised when installing, maintaining, or operating the appliance.

Always contact your manufacturer about problems or conditions you do not understand.

Recognize Safety Symbols, Words, Labels

WARNING

WARNING – Hazards or unsafe practices which **COULD** result in severe personal injury or death.

CAUTION

CAUTION – Hazards or unsafe practices which **COULD** result in minor personal injury.

Read and follow all instructions before using this appliance to prevent the potential risk of fire, electric shock, personal injury or damage to the appliance as a result of improper usage of the appliance. Use appliance only for its intended purpose as described in this guide.

General Instructions

To ensure proper and safe operation: Appliance must be properly installed and grounded by a qualified technician. **Do not** attempt to adjust, repair, service, or replace any part of your appliance unless it is specifically recommended in this guide. All other servicing should be referred to a qualified servicer.

Always disconnect power to appliance before servicing.

WARNING

- **ALL RANGES CAN TIP AND CAUSE INJURIES TO PERSONS**
- **INSTALL ANTI-TIP DEVICE PACKED WITH RANGE**
- **FOLLOW ALL INSTALLATION INSTRUCTIONS**



WARNING: To reduce risk of tipping of the appliance from abnormal usage or by excessive loading of the oven doors, the appliance must be secured by a properly installed anti-tip device.

To check if device is properly installed, look underneath range with a flashlight to make sure one of the rear leveling legs is properly engaged in the bracket slot. The anti-tip device secures the rear leveling leg to the floor when properly engaged. You should check this **anytime** the range has been moved.

In Case of Fire

Turn off appliance and ventilating hood to avoid spreading the flame. Extinguish flame then turn on hood to remove smoke and odor.

- **Cooktop:** Smother fire or flame in a pan with a lid or cookie sheet.
NEVER pick up or move a flaming pan.
- **Ovens:** Smother fire or flame by closing the oven doors.

Do not use water on grease fires. Use baking soda, a dry chemical or foam-type extinguisher to smother fire or flame.

WARNING

NEVER use an appliance as a step to reach cabinets above. Misuse of appliance doors, such as stepping, leaning or sitting on the door, may result in possible tipping of the appliance, breakage of door, and serious injuries.



Important Safety Instructions

If appliance is installed near a window, precautions should be taken to prevent curtains from blowing over surface elements.

NEVER use appliance to warm or heat the room. Failure to follow this instruction can lead to possible burns, injury, fire, or damage to the appliance.

NEVER wear loose-fitting or hanging garments while using the appliance. Clothing could catch utensil handles or ignite and cause burns if garment comes in contact with hot heating elements.

To ensure proper operation and to avoid damage to the appliance or possible injury, **do not** adjust, service, repair or replace any part of the appliance unless specifically recommended in this guide. Refer all other servicing to a qualified technician.

NEVER store or use gasoline or other combustible or flammable materials in the ovens, near surface units or in the vicinity of this appliance as fumes could create a fire hazard or an explosion.

To prevent grease fires, **do not** let cooking grease or other flammable materials accumulate in or near the appliance.

Use only dry potholders. Moist or damp potholders on hot surfaces may result in a steam burn. **Do not** let potholders touch hot heating elements. **Do not** use a towel or other bulky cloth which could easily touch hot heating elements and ignite.

Always turn off all controls when cooking is completed.

NEVER heat unopened containers on the surface unit or in the ovens. Pressure build-up in the container may cause container to burst resulting in burns, injury or damage to the appliance.

NEVER use aluminum foil to line drip bowls or cover oven racks or oven bottoms. This could result in risk of electric shock, fire, or damage to the appliance. Use foil only as directed in this guide.

Aerosol-type cans are **EXPLOSIVE** when exposed to heat and may be highly flammable. **Do not** use or store near appliance.

Cooktop

NEVER leave surface units unattended, especially when using high heat. An unattended boilover could cause smoking and a greasy spillover can cause a fire.

This appliance is equipped with different size surface elements. Select pans with flat bottoms large enough to cover element. Fitting pan size to element will improve cooking efficiency.

If pan is smaller than element, a portion of the element will be exposed to direct contact and could ignite clothing or potholder.

Only certain types of glass, glass-ceramic, ceramic, earthenware, or other glazed utensils are suitable for cooktop or oven service without breaking due to the sudden change in temperature. Follow utensil manufacturer's instructions when using glass.

This appliance has been tested for safe performance using conventional cookware. **Do not** use any devices or accessories that are not specifically recommended in this guide. **Do not** use element covers, stove top grills or add-on oven convection systems. The use of devices or accessories that are not expressly recommended in this guide can create serious safety hazards, result in performance problems, and reduce the life of the components of this appliance.

Turn pan handle toward center of cooktop, not out into the room or over another surface element. This reduces the risk of burns, ignition of flammable materials, or spillage if pan is accidentally bumped or reached by small children.

Glass-Ceramic Cooktop

NEVER cook on broken cooktop. If cooktop should break, cleaning solutions and spillovers may penetrate the broken cooktop and create a risk of electric shock. Contact a qualified technician immediately.

Clean cooktop with caution. Some cleaners can produce noxious fumes if applied to a hot surface. If a wet sponge, cloth, or paper towel is used on a hot cooking area, be careful to avoid steam burn.



Important Safety Instructions

Coil Elements

To prevent damage to removable surface heating elements, **do not** immerse, soak or clean in a dishwasher or self-clean oven. A damaged element could short, resulting in a fire or shock hazard.

Make sure drip bowls are in place as absence of these bowls during cooking could damage wiring.

Protective Liners: **Do not** use aluminum foil to line surface unit drip bowls or oven bottoms, except as suggested in the guide. Improper installation of these liners may result in a risk of electric shock or fire.

Heating Elements

NEVER touch surface or oven heating elements, areas near elements, or interior surfaces of ovens.

Heating elements may be hot even though they are dark in color. Areas near surface elements and interior surfaces of the ovens may become hot enough to cause burns. During and after use, **do not** touch or let clothing or other flammable materials contact heating elements, areas near elements, or interior surfaces of ovens until they have had sufficient time to cool.

Other potentially hot surfaces include: cooktop, areas facing the cooktop, oven vent, surfaces near the vent opening, oven doors, areas around the doors and oven windows.

Deep Fat Fryers

Use extreme caution when moving the grease pan or disposing of hot grease. Allow grease to cool before attempting to move pan.

Ovens

Use care when opening doors. Let hot air or steam escape before removing or replacing food.

For proper oven operation and performance, do not block or obstruct oven vent duct. When ovens are in use, the vent and surrounding area near the vent may become hot enough to cause burns.

Always place oven racks in desired locations while ovens are cool. If rack must be moved while an oven is hot, **do not** let potholder contact hot element in oven.

Self-Cleaning Ovens

CAUTION

Before self-cleaning the oven, remove the oven racks, broiler pan, food and any other utensils. Wipe spillovers to prevent excessive smoke and flare-ups.

Clean only parts listed in this guide. **Do not** clean door gasket. The gasket is essential for a good seal. **Do not** rub, damage, or move the gasket.

Do not use oven cleaners. No commercial oven cleaner or oven liner protective coating of any kind should be used in or around any part of the ovens.

Wipe up excessive spillovers, especially greasy spills, before the clean cycle to prevent smoking, flare-ups or flaming.

It is normal for the cooktop to become hot during a clean cycle. Therefore, avoid touching the cooktop, door, window or oven vent during a clean cycle.



Important Safety Instructions

Child Safety

CAUTION

NEVER store items of interest to children in cabinets above an appliance. Children climbing on the appliance or on the appliance doors to reach items could be seriously injured.

NEVER leave children alone or unsupervised in area where appliance is in use or is still hot.

NEVER allow children to sit or stand on any part of the appliance as they could be injured or burned.

Children must be taught that the appliance and utensils in or on it can be hot. Let hot utensils cool in a safe place, out of reach of small children. Children should be taught that an appliance is not a toy. Children **should not** be allowed to play with controls or other parts of the unit.

Ventilating Hoods

Clean range hood and filters frequently to prevent grease or other flammable materials from accumulating on hood or filter and to avoid grease fires.

Turn the fan on when flambéing foods (such as Cherries Jubilee) under the hood.

Important Safety Notice and Warning

The California Safe Drinking Water and Toxic Enforcement Act of 1986 (Proposition 65) requires the Governor of California to publish a list of substances known to the State of California to cause cancer or reproductive harm, and requires businesses to warn customers of potential exposures to such substances.

Users of this appliance are hereby warned that when the oven is engaged in the self-clean cycle, there may be some low-level exposure to some of the listed substances, including carbon monoxide. Exposure to these substances can be minimized by properly venting the oven to the outdoors by opening the windows and/or door in the room where the appliance is located during the self-clean cycle.

IMPORTANT NOTICE REGARDING PET BIRDS: Never keep pet birds in the kitchen or in rooms where the fumes from the kitchen could reach. Birds have a very sensitive respiratory system. Fumes released during an oven self-cleaning cycle may be harmful or fatal to birds. Fumes released due to overheated cooking oil, fat, margarine and overheated non-stick cookware may be equally harmful.

Save These Instructions for Future Reference



Surface Cooking

Surface Controls

Use to turn on the surface elements. An infinite choice of heat settings is available from **Low** to **High**. The knobs can be set on or between any of the settings.

Setting the Controls

1. Place pan on surface element.
2. Push the knob **in** and turn in either direction to the desired heat setting.
 - The control panel is marked to identify which element the knob controls. For example, the graphic at right indicates left front element.
3. There is an element **"ON" indicator light** on the control panel. When any surface control knob is turned on, the light will turn on. The light will turn off when all the surface elements are turned off.
4. After cooking, turn knob to **OFF**. Remove pan.



Suggested Heat Settings

The size, type of cookware and cooking operation will affect the heat setting.

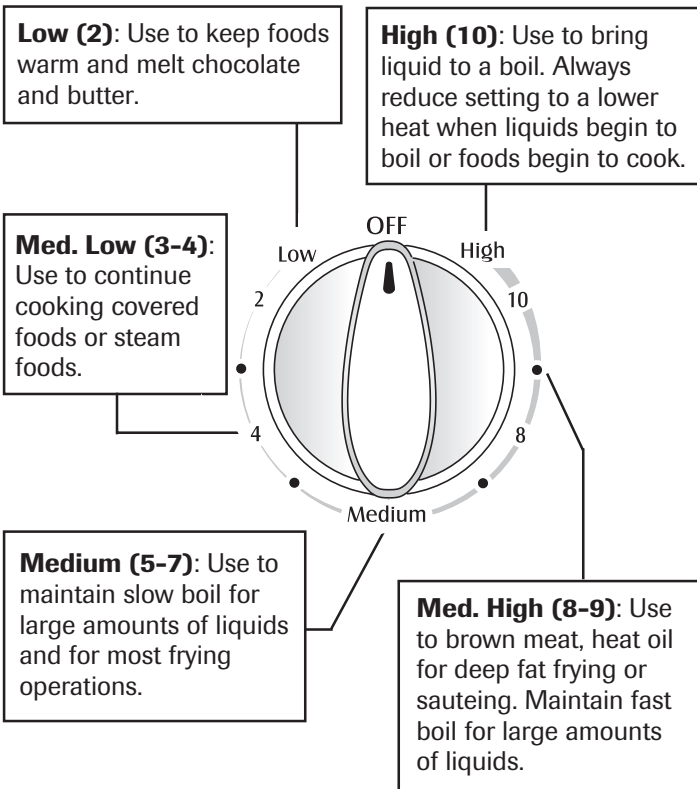

CAUTION

BEFORE COOKING

- Always place a pan on the surface unit before you turn it on. To prevent damage to range, never operate surface unit without a pan in place.
- **NEVER** use the cooktop to store for food or cookware.

DURING COOKING

- Be sure you know which knob controls which surface unit. Make sure you turned on the correct surface unit.
- Begin cooking on a higher heat setting then reduce to a lower setting to complete the operation. Never use a high heat setting for extended cooking.
- **NEVER** allow a pan to boil dry. This could damage the pan and the appliance.
- **NEVER** touch cooktop until it has cooled. Expect some parts of the cooktop, especially around the surface units, to become warm or hot during cooking. Use potholders to protect hands.

AFTER COOKING

- Make sure surface unit is turned off.
- Clean up messy spills as soon as possible.

OTHER TIPS

- If cabinet storage is provided directly above cooking surface, limit it to items that are infrequently used and can be safely stored in an area subjected to heat. Temperatures may be unsafe for items such as volatile liquids, cleaners or aerosol sprays.
- **NEVER** leave any items, especially plastic items, on the cooktop. The hot air from the vent may ignite flammable items, melt or soften plastics, or increase pressure in closed containers, causing them to burst.
- **NEVER** allow aluminum foil, meat probes or any other metal object, other than a pan on a surface element, to contact heating elements.

Coil Element Surface

Notes:

- Clean cooktop after each use.
- Wipe acidic or sugary spills as soon as the cooktop has cooled as these spills may discolor or etch the porcelain.

To protect drip bowl finish:

- To lessen discoloration and crazing, avoid using high heat for long periods.
- **Do not** use oversized cookware. Pans should not extend more than 1-2 inches beyond the element.
- When home canning or cooking with big pots, use the Canning Element (Model CE1). Contact your Maytag dealer for details or call 1-877-232-6771 USA or 1-800-688-8408 Canada to order.
- Clean frequently. (See page 19.)



Surface Cooking

Coil Elements

- When an element is on, it will cycle on and off to maintain the heat setting.
- Coil elements are self-cleaning. **Do not** immerse in water.

To remove: When cool, raise element. Carefully pull out and away from receptacle.

To replace: Insert element terminals into receptacle. Guide the element into place. Press down on the outer edge of element until it sits level on drip bowl.

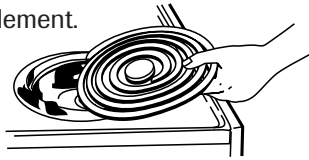

Drip Bowls

The drip bowls under each surface element catch boilovers and must always be used. Absence of drip bowls during cooking may damage wiring.

To prevent the risk of electric shock or fire, never line drip bowls with aluminum foil.

Drip bowls will discolor (blue/gold stains) or craze over time if overheated. This discoloration or crazing is permanent. This will not affect cooking performance.

Smoothtop Surface

Notes:

- **Cooktop may emit light smoke and odor** the first few times the cooktop is used. This is normal.
- **Smoothtop cooktops retain heat for a period of time after the element is turned off.** Turn the elements off a few minutes before food is completely cooked and use the retained heat to complete cooking. When the hot surface light turns off, the cooking area will be cool enough to touch. Because of the way they retain heat, the smoothtop elements will not respond to changes in settings as quickly as coil elements.
- In the event of a potential boilover, remove the pan from the cooking surface.
- **Never attempt to lift the cooktop.**
- The smoothtop surface may appear discolored when it is hot. This is normal and will disappear when the surface cools.

Cooking Areas

The cooking areas on your range are identified by permanent circles on the smoothtop surface. For most efficient cooking, fit the pan size to the element size.

Pans should not extend more than 1/2 to 1-inch beyond the cooking area.

When a control is turned on, a glow can be seen through the smoothtop surface. **The element will cycle on and off to maintain the preset heat setting, even on Hi.**

For more information on cookware, refer to Cookware Recommendations on page 7.

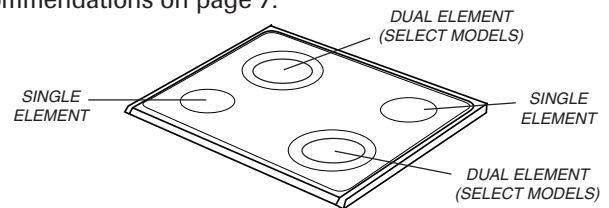

Hot Surface Light

The Hot Surface indicator light is located on the control panel. The light will be illuminated when any cooking area is hot. It will remain on, even after the control is turned off, until the area has cooled.



Hot Surface

Tips to Protect the Smoothtop Surface

Cleaning (see page 18 for more information)

- Before first use, clean the cooktop.
- Clean your cooktop daily or after each use. This will keep your cooktop looking good and can prevent damage.
- If a spillover occurs while cooking, immediately clean the spill from the cooking area while it is hot to prevent a tough cleaning chore later. Using extreme care, wipe spill with a clean dry towel.
- **Do not** allow spills to remain on the cooking area or the cooktop trim for a long period of time.
- **Never** use abrasive cleansing powders or scouring pads which will scratch the cooktop.
- **Never** use chlorine bleach, ammonia or other cleansers not specifically recommended for use on glass-ceramic.

To Prevent Marks and Scratches

- **Do not** use glass pans. They may scratch the surface.
- **Never** place a trivet or wok ring between the surface and pan. These items can mark or etch the top.

Cont.



Surface Cooking

- **Do not** slide aluminum pans across a hot surface. The pans may leave marks which need to be removed promptly. (See Cleaning, page 18.)
- Make sure the surface and the pan bottom are clean before turning on to prevent scratches.
- To prevent scratching or damage to the glass-ceramic top, **do not** leave sugar, salt or fats on the cooking area. Wipe the cooktop surface with a clean cloth or paper towel before using.
- **Never** slide heavy metal pans across the surface since these may scratch.

To Prevent Stains

- **Never** use a soiled dish cloth or sponge to clean the cooktop surface. A film will remain which may cause stains on the cooking surface after the area is heated.
- Continuously cooking on a soiled surface may/will result in a permanent stain.

To Prevent Other Damage

- **Do not** allow plastic, sugar or foods with high sugar content to melt onto the hot cooktop. Should this happen, clean immediately. (See Cleaning, page 18.)
- **Never** let a pan boil dry. This will damage the surface and pan.
- **Never** use cooktop as a work surface or cutting board.
- **Never** cook food directly on the surface.
- **Do not** use a small pan on a large element. Not only does this waste energy, but it can also result in spillovers burning onto the cooking area, which requires extra cleaning.
- **Do not** use non-flat specialty items that are oversized or uneven such as round-bottom woks, rippled-bottom and/or oversized canners and griddles.
- **Do not** use foil or foil-type containers. Foil may melt onto the glass. If metal melts on the cooktop, do not use. Call an authorized servicer.

Cookware Recommendations

Using the right cookware can prevent many problems, such as food taking longer to cook or achieving inconsistent results. Proper pans will reduce cooking times, use less energy, and cook food more evenly.

Flat Pan Tests

See if your pans are flat.

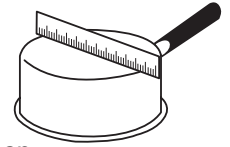

The Ruler Test:

1. Place a ruler across the bottom of the pan.
2. Hold it up to the light.
3. Little or no light should be visible under the ruler.

The Bubble Test:

1. Put 1 inch of water in the pan. Place on cooktop and turn control to **High**.
2. Watch the formation of the bubbles as the water heats. Uniform bubbles mean good performance, and uneven bubbles indicate hot spots and uneven cooking.

Select	Avoid
Flat, smooth-bottom pans.	Pans with grooved or warped bottoms. Pans with uneven bottoms do not cook efficiently and sometimes may not boil liquid.
Heavy-gauge pans.	Very thin-gauge metal or glass pans.
Pans that are the same size as the element.	Pans smaller or larger than the element by 1 inch.
Secure handles.	Cookware with loose or broken handles. Heavy handles that tilt the pan.
Tight-fitting lids.	Loose-fitting lids.
Flat-bottom woks.	Woks with a ring-stand bottom.

Canning and Oversize Cookware

All canners and large pots must have flat bottoms and must be made from heavy-gauge materials. This is critical on smoothtop surfaces. The base must not be more than 1 inch larger than the element.

When canners and pots do not meet these standards, cooking times may be longer, and cooktops may be damaged.

Some canners are designed with smaller bases for use on smoothtop surfaces.

When canning, use the High heat setting only until the water comes to a boil or pressure is reached in the canner. Reduce to the lowest heat setting that maintains the boil or pressure. If the heat is not turned down, the cooktop may be damaged.



Oven Cooking

Upper Oven Knob Control

(Manual Clean Only)

Oven Temp Knob

The Oven Temp knob is used to select and maintain the oven temperature. Always turn this knob just to the desired temperature. Do not turn to a higher temperature and then back.

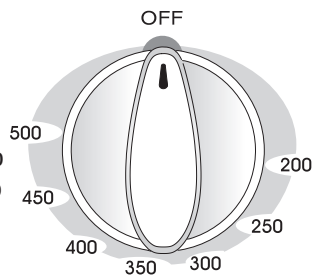

Setting the Control for Baking and Roasting:

1. Push in and turn Oven Temp knob to desired temperature. Allow 10-15 minutes for preheating.
2. Place food in the center of oven. Check food for doneness at minimum time in recipe. Cook longer if necessary.
3. Remove food from oven and turn Oven Temp knob to **OFF**.

Oven Light

Press the **Oven Light** switch on the control panel to turn the oven light on and off. Both upper and lower lights operate together.



Oven Light

Oven Bottom

Protect oven bottom against spillovers, especially acidic or sugary spills, as they may discolor the porcelain enamel. Use the correct pan size to avoid spillovers and boilovers. **Do not place utensils or aluminum foil directly on the oven bottom.**

Oven Vent

When the oven is in use the area near the vent may become hot enough to cause burns. **Never** block the vent opening.

The oven vent is located below the backguard vent shield on your range.

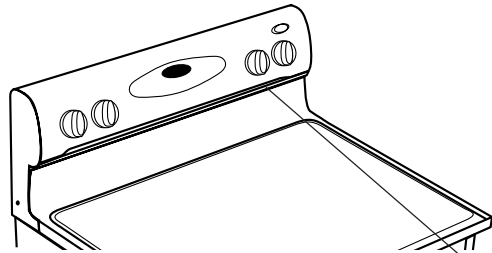

OVEN VENT LOCATION

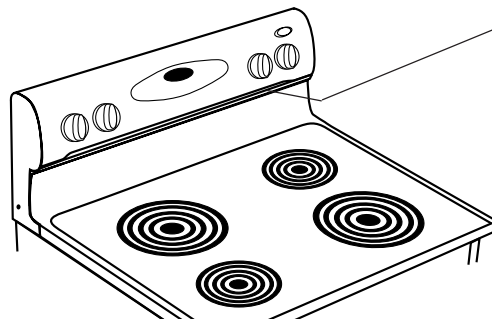

Do not place plastics near the vent opening as heat from the vent could distort or melt the plastic.



Oven Cooking

Lower Oven Control (Self-Clean)

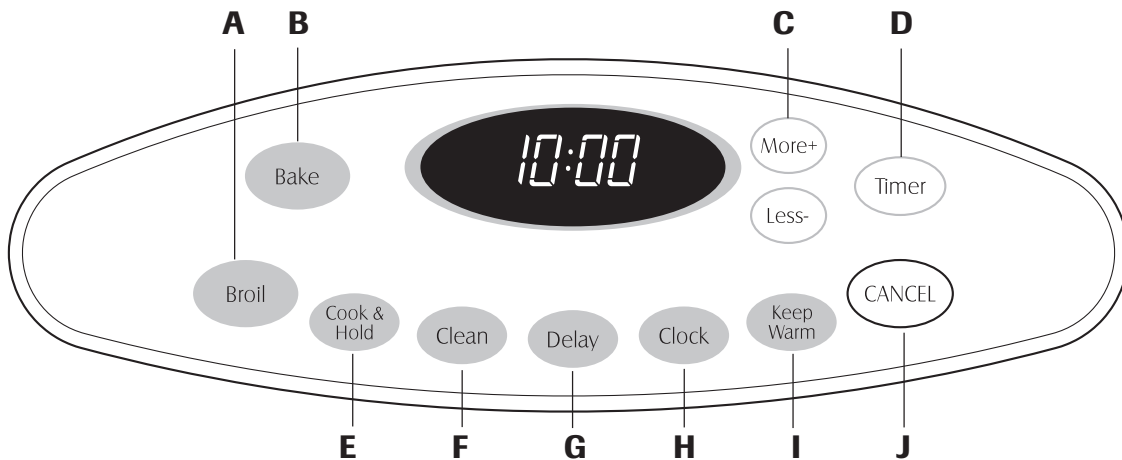

The control panel is designed for ease in programming. The display window on the control shows time of day, timer and oven functions. Control panel shown includes model specific features. (Styling may vary depending on model.)

A	Broil	Use for broiling and top browning.
B	Bake	Use for baking and roasting.
C	More+ or Less-	Enters or changes time, oven temperature. Sets HI or LO broil.
D	Timer	Sets timer.
E	Cook & Hold	Bakes for a preset time, then holds food warm for 1 hour.
F	Clean	Use to set self-clean cycle.
G	Delay	Programs the oven to start baking at a later time.
H	Clock	Use to set time-of-day clock.
I	Keep Warm	Use to keep cooked food warm in oven.
J	CANCEL	Cancels all operations except timer and clock.

Using the Touchpads

- Press the desired pad.
- Press the **More+** or **Less-** pad to enter time or temperature.
- A beep will sound when any pad is touched.
- A double beep will sound if a programming error occurs.

Note: Four seconds after pressing the **More+** or **Less-** pad, the time or temperature will automatically be entered. If more than 30 seconds elapse between touching a function pad and the **More+** or **Less-** pad, the function will be canceled and the display will return to the previous display.

Clock

The clock can be set to display time in a 12-hour or 24-hour format. The clock is set at the factory for the 12-hour format.

To change the clock to 24-hour format:

1. Press and hold the **CANCEL** and **Delay** pads for three seconds.
2. Press the **More+** or **Less-** pad to select 12 or 24 hour.
3. Set the time of day following the directions below.

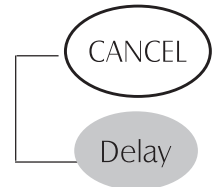

To set the Clock:

1. Press the **Clock** pad.
 - The colon will flash in the display.
2. Press the **More+** or **Less-** pad to set the time of day.
 - Colon continues flashing.
3. Press the **Clock** pad again or wait four seconds. The colon stops flashing.

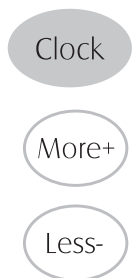

When electrical power is supplied or after a power interruption, the last clock time before power was interrupted will flash.

To recall the time of day when another time function is showing, press the **Clock** pad.

Clock time cannot be changed when the oven has been programmed for Delay Cook or Delay Clean or Cook & Hold.



Oven Cooking

To cancel the Clock display:

If you do not want the time of day to display:

Press and hold the **CANCEL** and **Clock** pads for three seconds. The time of day will disappear from the display

When the clock display is canceled, press the **Clock** pad to briefly display the time of day.

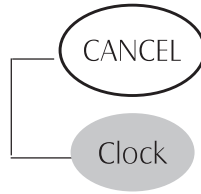

To restore the Clock display:

Press and hold the **CANCEL** and **Clock** pads for three seconds. The time of day will reappear in the display.

Timer

The timer can be set from one minute (0:01) up to 99 hours and 59 minutes (99:59).

The timer can be used independently of any other oven activity. It can also be set while another oven function is operating.

The timer does not control the oven. It only controls a beeper.

To set the Timer:

1. Press the **Timer** pad.
 - 0:00 lights in the display.
 - The colon flashes in the display.
2. Press the **More+** or **Less-** pad until the correct time appears in the display.
 - The colon will continue to flash.
3. Press **Timer** pad again or wait four seconds.
 - The colon continues flashing and the time begins counting down.
 - The last minute of the timer countdown will be displayed as seconds.
4. At the end of the set time, one long beep will sound.

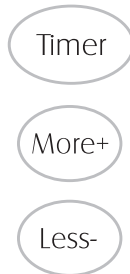

To cancel the Timer:

1. Press and hold the **Timer** pad for three seconds.
- OR**
2. Press the **Timer** pad and set the time to 0:00.

Locking the Controls

The touchpad controls can be locked for safety, cleaning, or to prevent unwanted use. They will not function when locked.

If the oven is currently in use, the controls and door cannot be locked.

The current time of day will remain in the display when the controls are locked.

To lock:

Press and hold the **CANCEL** and **Cook & Hold** pads for three seconds. (Press **CANCEL** pad first.)

- LOCK flashes in the display.

To unlock:

Press and hold the **CANCEL** and **Cook & Hold** pads for three seconds. (Press **CANCEL** pad first.)

- LOCK disappears from the display.

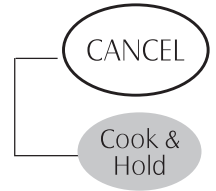

Fault Codes

BAKE or LOCK may flash rapidly in the display to alert you if there is an error or a problem. If BAKE or LOCK flash in the display, press **CANCEL** pad. If BAKE or LOCK continue to flash, disconnect power to the appliance. Wait a few minutes, and then reconnect power. If the flashing still continues, disconnect power to the appliance and call an authorized servicer.

Baking

To set Bake:

1. Press the **Bake** pad.
 - BAKE will flash.
 - 000 will light in the display.
2. Select the oven temperature. The oven temperature can be set from 170° to 550°. Press or press and hold the **More+** or **Less-** pads.
 - 350° will light when either pad is first pressed.
 - Press the **More+** pad to increase the temperature.
 - Press the **Less-** pad to decrease the temperature.
3. Press **Bake** pad again or wait four seconds.
 - BAKE will stop flashing and light in the display.

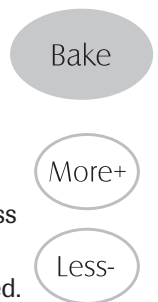

- 100° or the actual oven temperature will display. The temperature will rise in 5° increments until the preset temperature is reached.
4. Allow the oven to preheat for 8-15 minutes.
 - When the set oven temperature is reached, one long beep will sound.
 - To recall the set temperature during preheat, press the **Bake** pad.
 5. Place food in the oven.



Oven Cooking

6. Check cooking progress. Cook longer if needed.
7. When cooking is finished, press **CANCEL**.
8. Remove food from the oven.

CANCEL

Notes:

- **To change the oven temperature during cooking,** press the **Bake** pad and then the **More+** or **Less-** pad until the desired temperature is displayed.
- **To change the oven temperature during preheat,** press the **Bake** pad *twice*, then press the **More+** or **Less-** pads until the desired temperature is displayed.
- If you forget to turn off the oven, it will automatically shut off at the end of 12 hours. If you wish to deactivate this feature, see page 13.

Baking Differences Between Your Old and New Oven

It is normal to notice some baking time differences between a new oven and an old one. See *Adjusting the Oven Temperature* on page 13.

Cook & Hold

Cook & Hold allows you to bake for a preset amount of time, followed by a one-hour Keep Warm cycle.

To set Cook & Hold:

1. Press the **Cook & Hold** pad.
 - BAKE and HOLD flash.
 - 000 lights in the display.
2. Select the oven temperature. The oven temperature can be set from 170° to 550°. Press or press and hold the **More+** or **Less-** pad.
 - Press the **More+** pad to increase the temperature.
 - Press the **Less-** pad to decrease the temperature.
3. Press **Cook & Hold** again OR wait four seconds.
 - HOLD flashes.
 - 00:00 flashes in the display.
4. Enter the amount of time you want to bake by pressing the **More+** or **Less-** pad. Bake time can be set from ten minutes (00:10) to 11 hours, 59 minutes (11:59).
 - BAKE and HOLD light in the display.
 - The baking time will light in the display.
 - The baking time will start counting down.

Cook & Hold

More+

Less-

When the cooking time has elapsed:

- Four beeps will sound.
- BAKE will turn off.
- HOLD and WARM will light.
- 170° will display.



After one hour in HOLD WARM:

- “End” will display.
- The time of day reappears in the display.

To cancel Cook & Hold at any time:

Press the **CANCEL** pad. Remove food from oven.

CANCEL

Delay Bake

! CAUTION

Do not use delayed baking for highly perishable foods such as dairy products, pork, poultry, or seafood.

When using Delay, the oven begins to cook later in the day. Set the amount of time that you want to delay before the oven turns on and how long you want to cook. The oven begins to heat at the selected time and cooks for the specified length of time, then keeps food warm for up to one hour.

Delay time can be set from 10 minutes (00:10) to 11 hours, 59 minutes (11:59).

To set a Delayed Baking cycle:

1. Press the **Delay** pad.
 - DELAY flashes.
 - 00:00 appears in the display.
2. Press the **More+** or **Less-** pad *to set the delay time.*

While DELAY is still flashing:

3. Press the **Cook & Hold** pad.
 - 000 lights in the display.
 - BAKE and HOLD flash.
4. Press **More+** pad *to set the baking temperature.*
 - 00:00 and HOLD flash.
 - BAKE stays lit.

Delay

More+

Less-

Cook & Hold



Oven Cooking

5. Press **More+** pad to set the baking time.

- The Delay time, DELAY, BAKE and HOLD light in the display.



When the Delay time has expired:

- DELAY will turn off.
- Baking time is displayed.
- BAKE and HOLD are displayed.

To set a Delay when Cook & Hold has already been programmed:

1. Press the **Delay** pad.

- DELAY flashes.
- 00:00 appears in the display.

Delay

2. Press the **More+** or **Less-** pad to set the delay time.

- After four seconds, DELAY will stay lit to remind you that a delayed cooking cycle has been set.

More+

Less-

When the Delay time has expired and the oven starts:

- The baking time will be displayed.
- DELAY will turn off.
- BAKE and HOLD will remain lit.

To cancel:

Press the **CANCEL** pad.

- All timed and untimed cooking functions will be canceled.
- The time of day will reappear in the display.

CANCEL

Notes:

- **Do not** use delayed baking for items that require a preheated oven, such as cakes, cookies, and breads.
- **Do not** use delayed baking if oven is already hot.

Keep Warm

For safely keeping foods warm or for warming breads and plates.

To set Keep Warm:

1. Press the **Keep Warm** pad.

- WARM flashes.
- 000 appears in the display.

Keep Warm

2. Select the Keep Warm temperature. The Keep Warm temperature can be set from 145° F to 190° F. Press or press and hold the **More+** or **Less-** pad.

More+

Less-

- 170° will light when either pad is first pressed.

- Press the **More+** pad to increase the temperature.
- Press the **Less-** pad to decrease the temperature.

WARM and the temperature will be displayed while Keep Warm is active.



To cancel Keep Warm:

1. Press the **CANCEL** pad.

CANCEL

2. Remove food from the oven.

Notes:

- For optimal food quality, oven cooked foods should be kept warm for no longer than 1 to 2 hours.
- To keep foods from drying, cover loosely with foil or a lid.
- **To warm dinner rolls:**
 - cover rolls loosely with foil and place in oven.
 - press **Keep Warm** and **More+** pads to set 170° F.
 - warm for 12-15 minutes.
- **To warm plates:**
 - place 2 stacks of up to four plates each in the oven.
 - press **Keep Warm** and **More+** pads to set 170° F.
 - warm for five minutes, turn off the oven and leave plates in the oven for 15 minutes more.
 - use only oven-safe plates, check with the manufacturer.
 - **do not** set warm dishes on a cold surface as rapid temperature changes could cause crazing or breakage.



Oven Cooking

Automatic Shut-Off/ Sabbath Mode

The oven will automatically turn off after 12 hours if you accidentally leave it on. This safety feature can be turned off.

To cancel the 12-hour shut-off and run the oven continuously for 72 hours:

1. Set the oven to Bake (see page 10).
2. Press and hold the **Clock** pad for five seconds.
 - SAb will be displayed and flash for five seconds.
 - SAb will then be displayed continuously until turned off or until the 72-hour time limit is reached.
 - BAKE will also be displayed if a bake cycle is in use while the oven is in Sabbath Mode.

Clock

All other functions EXCEPT BAKE (Timer, Keep Warm, Clean, etc.) are locked out during the Sabbath Mode.

To cancel Bake when in Sabbath Mode:

Press **CANCEL**.

- BAKE will turn off in the display.
- No beeps will sound.

CANCEL

To cancel the Sabbath Mode:

1. Press the **Clock** pad for five seconds.
- OR**
2. After 72 hours, the Sabbath Mode will end.
 - SAb will flash for 5 seconds.
 - The time of day will return to the display.

Clock

Adjusting the Oven Temperature

Oven temperatures are carefully tested for accuracy at the factory. It is normal to notice some baking or browning differences between a new oven and an old one. As ranges get older, the oven temperature can shift.

You may adjust the oven temperature if you think the oven is not baking or browning correctly. To decide how much to change the temperature, set the temperature 25° higher or lower than your recipe recommends, then bake. The results of the “test” should give you an idea of how much to adjust the temperature.

To adjust the oven temperature:

1. Press **Bake**.
2. Enter 550° F by pressing the **More+** pad.
3. Press and hold the **Bake** pad for several seconds or until “0°” appears in the display.

If the oven temperature was previously adjusted, the change will be displayed. For example, if the oven temperature was reduced by 15° the display will show “-15°”.
4. Press the **More+** or **Less-** pad to adjust the temperature.

Each time a pad is pressed, the temperature changes by 5°. The oven temperature can be increased or decreased by 5° to 35°.
5. The time of day will automatically reappear in the display.

Bake

More+

You do not need to readjust the oven temperature if there is a power failure or interruption. Broiling and cleaning temperatures cannot be adjusted.

Notes:

- Sabbath Mode can be turned on at any time with or without the oven on.
- Sabbath Mode cannot be turned on if the touchpads are locked out or when the door is locked.
- If the oven is baking when Sabbath Mode is set, BAKE will go out at the end of the baking cycle. There will be no audible beeps.
- If the oven light is desired while in Sabbath Mode, it must be turned on before the Sabbath Mode is started.
- When the Sabbath Mode is started, no preheat beep will sound.
- All prompts, messages and beeps are deactivated when Sabbath Mode is active.
- The automatic door lock does not operate during the Sabbath Mode.
- Pressing **CANCEL** will cancel a Bake cycle, however the control will stay in the Sabbath Mode.
- If power fails, the oven will power up in Sabbath Mode with 72 hours remaining and no cycle active.



Oven Cooking

Broiling (Lower Oven Only)

To set Broil:

- Press the **Broil** pad.
 - BROIL flashes.
 - SEt is displayed.
- Press the **More+** pad to set HI broil or press the **Less-** pad to set LO broil.
 - HI or LO will be displayed.
 - Select **HI Broil** (550° F) for normal broiling. Select **LO Broil** (450° F) for low-temperature broiling of longer cooking foods such as poultry.
- After four seconds, the oven will start.
 - BROIL will remain lit.



- For optimum browning, preheat broil element for 3-4 minutes before adding food.
- Place food in the oven. Leave oven door open about four inches (the first stop).
- Turn meat once about halfway through cooking.

- When food is cooked, press the **CANCEL** pad. Remove food and broiler pan from the oven.
 - The time of day will reappear in the display.



Notes:

- For best results when broiling, use a pan designed for broiling.
- Expect broil times to increase and browning to be slightly lighter if appliance is installed on a 208-volt circuit.
- HI is used for most broiling. Use LO Broil when broiling longer cooking foods. The lower temperature allows food to cook to the well done stage without excessive browning.
- To change oven temperature during broiling**, press the **Broil** pad and then the **More+** or **Less-** pad to switch between LO and HI Broil.
- Broil times may be longer when the lower broiling temperature is selected.
- Most foods should be turned halfway through broiling time.

Broiling Chart

FOODS	RACK POSITION	APPROX. TIME FIRST SIDE	APPROX. TIME SECOND SIDE
Beef			
Steak, 1" thick, Medium	4	8 minutes	7 - 12 minutes
Well Done	4	10 minutes	8 - 14 minutes
Hamburgers, 3/4" thick, Well Done	4 or 5	9 minutes	6 - 9 minutes
Pork			
Bacon	4	6 - 10 minutes	(no turning)
Chops, 1"	4	10 - 11 minutes	12 - 14 minutes
Ham Slice	4	5 minutes	3 - 7 minutes
Poultry			
Breast Halves	3	LO Broil 15 minutes	LO Broil 15 - 25 minutes
Seafood			
Fish Steaks, buttered, 1" thick	4	10 - 15 minutes	(no turning)
Lobster Tails, 3-4 oz. each	3	7 - 10 minutes	(no turning)

Note: This chart is a suggested guide. The times may vary with the food being cooked.



Oven Cooking

Oven Racks

! CAUTION

- **Do not** attempt to change the rack position when the oven is hot.
- **Do not** use the oven for storing food or cookware.

All racks are designed with a lock-stop edge.

Upper Oven

- Is equipped with one rack and rack position.
- When pulling the upper oven rack out to remove or check food, grasp the **top edge** of the rack.

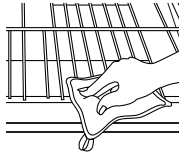

Lower Oven

- Is equipped with two regular flat racks.

To remove oven racks:

- Pull rack straight out until it stops at the lock-stop position; lift up on the front of the rack and pull out.

To replace oven racks:

- Place rack on the rack support in the oven; tilt the front end up slightly; slide rack back until it clears the lock-stop position; lower front and slide back into the oven.



RACK 3:

Use for most baked goods on a cookie sheet or jelly roll pan, layer cakes, fruit pies, or frozen convenience foods, and for broiling.

RACK 2:

Use for roasting small cuts of meat, casseroles, baking loaves of bread, bundt cakes or custard pies, and two-rack baking.

RACK 1:

Use for roasting large cuts of meat and poultry, frozen pies, dessert souffles or angel food cake, and two-rack baking.

Multiple Rack Cooking:

Two rack: Use rack positions 2 and 4, 1 and 4, or 2 and 5.

Baking Layer Cakes on Two Racks

For best results when baking cakes on two racks, use racks 2 and 4.

Place the cakes on the rack as shown.

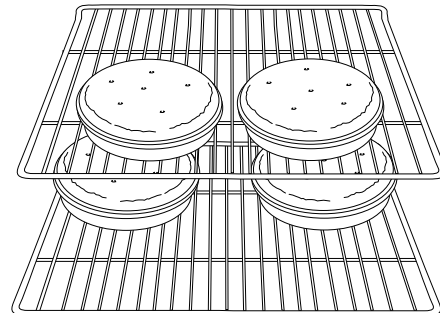

Rack Positions (lower oven)

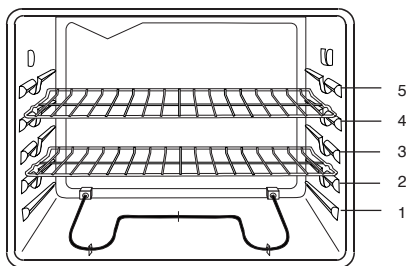

RACK 5: (highest position)

Use for toasting bread or broiling very thin foods and two-rack baking.

RACK 4:

Use for two-rack baking and for broiling.



Care & Cleaning

Self-Clean Oven (Lower Oven Only)

CAUTION

- It is normal for parts of the range to become hot during a self-clean cycle.
- To prevent damage to oven door, **do not** attempt to open the door when LOCK is displayed.
- Avoid touching cooktop, door, window or oven vent area during a clean cycle.
- **Do not** use commercial oven cleaners on the oven finish or around any part of the oven. They will damage the finish or parts.
- **Do not leave baking/pizza stone in the oven during self-clean.**

The self-clean cycle uses above-normal cooking temperatures to automatically clean the oven interior.

The oven should be cleaned regularly by wiping up spillovers to prevent excessive smoke and flare-ups. Do not allow a heavy build-up of soil to accumulate in the oven.

During the cleaning process, the kitchen should be well ventilated to get rid of normal odors associated with cleaning.

Before Self-Cleaning

1. Turn off the oven light before cleaning. The light may burn out during the clean cycle.
2. Remove broiler pan, all pans, and oven racks from the oven. The oven racks will discolor and may not slide easily after a self-clean cycle if they are not removed.

3. Clean oven frame, door frame, area outside of gasket, and around the opening in the door gasket with a nonabrasive cleaner such as Bon Ami* or detergent and water. The self-cleaning process does not clean these areas. They should be cleaned to prevent soil from baking on during the clean cycle. (The gasket is the seal around the oven door and window.)

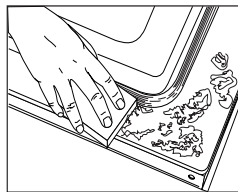

4. To prevent damage, **do not** clean or rub the gasket around the oven door. The gasket is designed to seal in heat during the clean cycle.
5. Wipe up excess grease or spillovers from the oven bottom. This prevents excessive smoking, flare-ups or flaming during the clean cycle.

6. Wipe up sugary and acidic spillovers such as sweet potatoes, tomato, or milk-based sauces. Porcelain enamel is acid-resistant, not acid-proof. The porcelain finish may discolor if acidic spills are not wiped up before a self-clean cycle.

To set Self-Clean:

Note: Oven temperature must be below 400° F to program a clean cycle.

1. Close the oven door.
2. Press the **Clean** pad.



- CLEAN flashes in the display.

If the door is not closed within 25 seconds, the self-cleaning operation will be canceled and the display will return to the time of day.

3. Press the **More+** or **Less-** pad.

- MEd for medium amount of soil (3 hours) appears in the display.



If the door is not closed, DOOR will appear in the display. After 45 seconds, three beeps will sound, the self-cleaning operation will be canceled and the display will return to the time of day.



4. Press the **More+** pad *twice* for heavy soil (4 hours).

- HVy will be displayed.

Press **Less-** pad *twice* for light soil (2 hours).

- LITE will be displayed.

Choosing the soil level of the oven automatically programs the self-cleaning time. LOCK flashes in the display.

5. After four seconds, the oven will start cleaning.

- The cleaning time will start counting down in the display.
- LOCK will appear in the display and will flash until the doors are locked. LOCK will then remain lit.
- CLEAN will remain lit in the display.

To Delay a Self-Clean Cycle:

1. Press the **Delay** pad.
 - DELAY and 00:00 appear in the display.
 - The colon flashes in the display.
2. Press the **More+** or **Less-** pad *to set the amount of time you want to delay* the cycle. Delay time can be set from ten minutes (10:00) to 11 hours, 59 minutes (11:59).



Cont.

* Brand names for cleaning products are registered trademarks of the respective manufacturers.



Care & Cleaning

3. Press the **Clean** pad while DELAY is displayed.

- CLEAN will flash.

If the door is not closed within 25 seconds, the self-cleaning operation will be canceled and the display will return to the time of day.

4. Press the **More+** or **Less-** pad.

- MEd for medium amount of soil (3 hours) is displayed.

If the door is not closed, DOOR will appear in the display. After 45 seconds, three beeps will sound, the self-cleaning operation will be canceled and the display will return to the time of day.

5. Press the **More+** pad *twice* for heavy soil (4 hours).

- HVy will be displayed.

Press the **Less-** pad *twice* for light soil (2 hours).

- LITE will be displayed.

Choosing the soil level of the oven automatically programs the self-cleaning time.

6. After four seconds, CLEAN, DELAY and LOCK will appear in the display to show that the oven is set for a delayed clean operation. The delay time is displayed and will begin to count down.



When the Self-Clean cycle starts:

- DELAY will turn off.
- CLEAN, HOURS, LOCK and the clean time will appear in the display.

To cancel the Self-Clean cycle:

Press the **CANCEL** pad.

- All words disappear from the display.
- All functions are canceled.
- The time of day appears in the display.

Clean

Less-

More+

During the Self-Clean Cycle

When LOCK shows in the display, the oven door is locked. To prevent damage to the door, do not force the door open when LOCK is displayed.

Smoke and Smells

You may see some smoke and smell an odor the first few times the oven is cleaned. This is normal and will lessen in time.

Smoke may also occur if the oven is heavily soiled or if a broiler pan was left in the oven.

Sounds

As the oven heats, you may hear sounds of metal parts expanding and contracting. This is normal and will not damage the oven.

After Self-Cleaning

About one hour after the end of the self-clean cycle, LOCK will turn off. The door can then be opened.

Some soil may leave a light gray, powdery ash. Remove it with a damp cloth. If soil remains after wiping, that means the clean cycle was not long enough. The soil will be removed during the next clean cycle.

If oven racks were left in the oven and do not slide smoothly after a clean cycle, wipe racks and rack supports with a small amount of vegetable oil to make them easier to move.

Fine lines may appear in the porcelain because it went through heating and cooling. This is normal and will not affect performance.

A white discoloration may appear after cleaning if acidic or sugary foods were not wiped up before the self-clean cycle. This discoloration is normal and will not affect performance.

Notes:

- If the oven door is left open, DOOR will appear in the display until the door is closed.
- If more than five seconds elapse between pressing the Clean pad and the **More+** or **Less-** pad, the program will automatically return to the previous display.
- The oven door will be damaged if the oven door is forced to open when LOCK is still displayed.



Care & Cleaning

Cleaning Procedures

CAUTION

- Be sure appliance is off and all parts are cool before handling or cleaning. This is to avoid damage and possible burns.
- To prevent staining or discoloration, clean appliance after each use.
- If a part is removed, be sure it is correctly replaced.

- * Brand names are registered trademarks of the respective manufacturers.
- ** To order call 1-877-232-6771 USA or 1-800-688-8408 Canada.

PART	PROCEDURE
Backguard and Cooktop – Porcelain Enamel	<p>Porcelain enamel is glass fused on metal and may crack or chip with misuse. It is acid resistant, not acid proof. All spillovers, especially acidic or sugary spillovers, should be wiped up immediately with a dry cloth.</p> <ul style="list-style-type: none"> • When cool, wash with soapy water, rinse and dry. • Never wipe off a warm or hot surface with a damp cloth. This may cause cracking or chipping. • Never use oven cleaners, abrasive or caustic cleaning agents on exterior finish of range.
Broiler Pan and Insert (select models)	<p>Never cover insert with aluminum foil as this prevents the fat from draining to the pan below.</p> <ul style="list-style-type: none"> • Place soapy cloth over insert and pan; let soak to loosen soil. • Wash in warm soapy water. Use scouring pad to remove stubborn soil. • Broiler pan and insert can be cleaned in dishwasher.
Clock and Control Pad Area	<ul style="list-style-type: none"> • To activate control lock for cleaning, see <i>Locking the Controls</i> page 10. • Wipe with a damp cloth and dry. Do not use abrasive cleaning agents as they may scratch the finish. • Glass cleaners may be used if sprayed on a cloth first. DO NOT spray directly on control pad and display area.
Control Knobs	<ul style="list-style-type: none"> • Remove knobs in the OFF position by pulling forward. • Wash, rinse and dry. Do not use abrasive cleaning agents as they may scratch the finish. • Turn on each element to be sure the knobs have been correctly replaced.
Cooktop – Glass-Ceramic (Smotthtop)	<p>Never use oven cleaners, chlorine bleach, ammonia or glass cleaners with ammonia. Note: Call an authorized servicer if the glass-ceramic top should crack, break or if metal or aluminum foil should melt on the cooktop.</p> <ul style="list-style-type: none"> • Allow the cooktop to cool before cleaning. • General – Clean cooktop after each use, or when needed, with a damp paper towel and Cooktop Cleaning Creme* (Part No. 20000001)**. Then buff with a clean dry cloth. <p>Note: Permanent stains will develop if soil is allowed to cook on by repeatedly using the cooktop when soiled.</p> <ul style="list-style-type: none"> • Heavy Soils or Metal Marks – Dampen a “scratchless” or “never scratch” scrubber sponge. Apply Cooktop Cleaning Creme* (Part No. 20000001)** and scrub to remove as much soil as possible. Apply a thin layer of the creme over the soil, cover with a damp paper towel and let stand 30 to 45 minutes (2-3 hours for very heavy soil). Keep moist by covering the paper towel with plastic wrap. Scrub again, then buff with a clean dry cloth. <p>Note: Only use a CLEAN, DAMP “scratchless” pad that is safe for non-stick cookware. The pattern and glass will be damaged if the pad is not damp, if the pad is soiled, or if another type of pad is used.</p> <ul style="list-style-type: none"> • Burned-On or Crusty Soils – Scrub with a “scratchless” or “never scratch” scouring pad and Cooktop Cleaning Creme*. <p>Note: Hold a razor blade scraper at 30° angle and scrape any remaining soil. Then clean as described above. Do not use the razor blade for daily cleaning as it may wear the pattern on the glass.</p> <ul style="list-style-type: none"> • Melted Sugar or Plastic – Immediately turn element to LOW and scrape sugar or plastic from hot surface to a cool area. Then turn element OFF and allow to cool. Clean residue with razor blade scraper and Cooktop Cleaning Creme*.

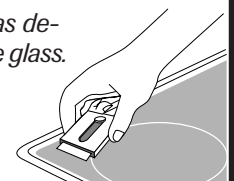



Care & Cleaning

PART	PROCEDURE
Drip Bowls – Chrome	<p>Chrome will discolor if overheated. This is normal and will not affect cooking performance.</p> <ul style="list-style-type: none"> When cool, wash after each use, rinse and dry to prevent staining or discoloration. May be washed in the dishwasher. To clean heavy soil, soak in hot sudsy water, then use a mild abrasive cleaner such as Soft Scrub* and a plastic scouring pad.
Door Handles, Side Panels – Painted Enamel	<ul style="list-style-type: none"> When cool, wash with warm soapy water, rinse and dry. Never wipe a warm or hot surface with a damp cloth as this may damage the surface and may cause a steam burn. For stubborn soil, use mildly abrasive cleaning agents such as baking soda paste or Bon Ami.* Do not use abrasive, caustic or harsh cleaning agents such as steel wool pads or oven cleaners. These products will scratch or permanently damage the surface. <p>Note: Use a dry towel or cloth to wipe up spills, especially acidic or sugary spills. Surface may discolor or dull if soil is not immediately removed. This is especially important for white surfaces.</p>
Oven Windows and Doors – Glass	<ul style="list-style-type: none"> Avoid using excessive amounts of water which may seep under or behind glass, causing staining. Wash with soap and water. Rinse with clear water and dry. Glass cleaner can be used if sprayed on a cloth first. Do not use abrasive materials such as scouring pads, steel wool or powdered cleaners as they will scratch glass.
Oven Interiors	<p>Self-Clean – Lower Oven Only:</p> <ul style="list-style-type: none"> Follow instructions on page 16-17 to set a self-clean cycle. <p>Manual Clean:</p> <ul style="list-style-type: none"> Clean frequently using mild abrasive cleaners and a plastic pad. Do not use metallic scouring pads because they will scratch the surface. When using commercial oven cleaners follow the manufacturer’s instructions. Wipe up acidic spills (tomato or milk based foods) as soon as possible with soap and water. If the spill is not wiped up, it may discolor the porcelain. <p>To make cleaning easier, remove the oven door, if desired. (See Maintenance section on page 20.)</p>
Oven Racks	<ul style="list-style-type: none"> Clean with soapy water. Remove stubborn soil with cleansing powder or soap-filled scouring pad. Rinse and dry. Racks will permanently discolor and may not slide smoothly if left in the oven during a self-clean operation. If this occurs, wipe the rack edge and rack support with a small amount of vegetable oil to restore ease of movement, then wipe off excess oil.
Stainless Steel (select models)	<ul style="list-style-type: none"> DO NOT USE ANY CLEANING PRODUCT CONTAINING CHLORINE BLEACH. DO NOT USE ABRASIVE OR ORANGE CLEANERS. ALWAYS WIPE WITH THE GRAIN WHEN CLEANING. Daily Cleaning/Light Soil -- Wipe with one of the following - soapy water, white vinegar/water solution, Formula 409 Glass and Surface Cleaner* or a similar glass cleaner - using a sponge or soft cloth. Rinse and dry. To polish and help prevent fingerprints, follow with Stainless Steel Magic Spray (Part No. 20000008)**. Moderate/Heavy Soil -- Wipe with one of the following - Bon Ami, Smart Cleanser, or Soft Scrub* - using a damp sponge or soft cloth. Rinse and dry. Stubborn soils may be removed with a damp multi-purpose Scotch-Brite* pad; rub evenly with the grain. Rinse and dry. To restore luster and remove streaks, follow with Stainless Steel Magic Spray**. Discoloration -- Using a damp sponge or soft cloth, wipe with Cameo Stainless Steel Cleaner*. Rinse immediately and dry. To remove streaks and restore luster, follow with Stainless Steel Magic Spray**.

* Brand names for cleaning products are registered trademarks of the respective manufacturers.

** To order direct, call 1-877-232-6771 USA or 1-800-688-8408 Canada.

Oven Doors

! CAUTION

- **Do not** place excessive weight on or stand on open oven doors. This could cause the range to tip over, break the door, or injure the user.
- **Do not** attempt to open or close doors or operate oven until doors are properly replaced.
- **Never** place fingers between hinge and front oven frame. Hinge arms are spring mounted. If accidentally hit, the hinge will slam shut against oven frame and could injure your fingers.

Both the upper and lower oven doors are removable.

To remove:

1. When cool, open the oven door to the broil stop position (opened about four inches).
2. Grasp door at each side. **Do not** use the door handle to lift door.
3. Lift up evenly until door clears hinge arms.

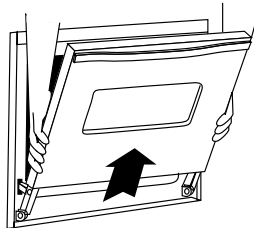

To replace:

1. Grasp door at each side.
2. Align slots in the door with the hinge arms on the range.
3. Slide the door down onto the hinge arms until the door is completely seated on the hinges. Push down on the top corners of the door to completely seat door on hinges. Door should not appear crooked.

Note: The oven door on a new range may feel “spongy” when it is closed. This is normal and will decrease with use.

Oven Windows

To protect the oven door window:

1. **Do not** use abrasive cleaning agents such as steel wool scouring pads or powdered cleansers as they may scratch the glass.
2. **Do not** hit the glass with pots, pans, furniture, toys, or other objects.
3. **Do not** close the oven door until the oven racks are in place.

Scratching, hitting, jarring or stressing the glass may weaken its structure causing an increased risk of breakage at a later date.

Upper and Lower Oven Lights

! CAUTION

- Disconnect power to range before replacing light bulb.
- Use a dry potholder to prevent possible harm to hands when replacing bulb.
- Be sure bulb is cool before touching bulb.
- **Do not** touch hot bulb with a damp cloth as this may cause the bulb to break.

To replace oven light bulb:

1. When oven is cool, hold bulb cover in place, then slide wire retainer off cover. **Note:** Bulb cover will fall if not held in place while removing wire retainer.
2. Remove bulb cover and light bulb (lower oven only).
3. Replace with a 40-watt appliance bulb.
4. Replace bulb cover and secure with wire retainer (lower oven only).
5. Reconnect power to range. Reset clock.

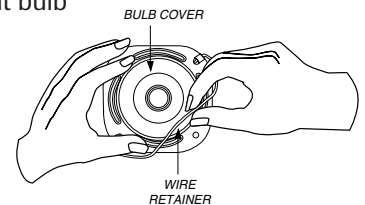

Leveling Legs

! CAUTION

Be sure the anti-tip bracket secures one of the rear leveling legs to the floor. This bracket prevents the range from accidentally tipping.

Be sure the range is leveled when installed. If the range is not level, turn the leveling legs, located at each corner of the range, until range is level.

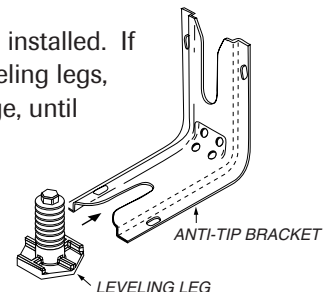

Troubleshooting

PROBLEM	SOLUTION
For most concerns, try these first.	<ul style="list-style-type: none"> • Check if oven controls have been properly set. • Check to be sure plug is securely inserted into receptacle. • Check or re-set circuit breaker. Check or replace fuse. • Check power supply.
Part or all of appliance does not work.	<ul style="list-style-type: none"> • Check if surface and/or oven controls have been properly set. See pages 5, 8 & 10. • Check if oven door is unlocked after self-clean cycle. See page 17. • Check if oven is set for a delayed cook or clean program. See pages 11 & 16. • Check if Control Lock is activated. See page 10. • Check if control is in Sabbath Mode. See page 13.
Oven light and/or clock does not function.	<ul style="list-style-type: none"> • The light bulb is loose or defective. • The oven light does not work during self-cleaning process. • Oven may be in Sabbath Mode. See page 13.
Clock, indicator words, and/or lights operate but oven does not heat.	<ul style="list-style-type: none"> • Oven may be set for a Cook & Hold or delay function. • The Control Lock may have been set. See page 10.
Baking results are not as expected or differ from previous oven.	<ul style="list-style-type: none"> • Make sure the oven vent has not been blocked. See page 8 for location. • Check to make sure range is level. • Temperatures often vary between a new oven and an old one. As ovens age, the oven temperature often “drifts” and may become hotter or cooler. See page 13 for instructions on adjusting the oven temperature. Note: It is not recommended to adjust the temperature if only one or two recipes are in question.
Food is not broiling properly or smokes excessively.	<ul style="list-style-type: none"> • Check oven rack positions. Food may be too close to element. • Broil element was not preheated. • Aluminum foil was incorrectly used. Never line the broiler insert with foil. • Oven door was closed during broiling. Leave the door open to the first stop position (about 4 inches). • Trim excess fat from meat before broiling. • A soiled broiler pan was used. • Voltage in house may be low.
Oven will not self-clean.	<ul style="list-style-type: none"> • Check to make sure the cycle is not set for a delayed start. See page 16. • Check if door is closed. • Check if control is in Sabbath Mode. See page 13. • Oven may be over 400° F. Oven temperature must be below 400° F to program a clean cycle.
Oven did not clean properly.	<ul style="list-style-type: none"> • Longer cleaning time may be needed. • Excessive spillovers, especially sugary and/or acidic foods, were not removed prior to the self-clean cycle.
Oven door will not unlock after self-clean cycle.	<ul style="list-style-type: none"> • Oven interior is still hot. Allow about one hour for the oven to cool after the completion of a self-clean cycle. The door can be opened when LOCK is not displayed. • The control and door may be locked. See page 10.

Troubleshooting

PROBLEM	SOLUTION
<p>Smoothtop surface shows wear.</p>	<ul style="list-style-type: none"> • Tiny scratches or abrasions. <ul style="list-style-type: none"> - Make sure cooktop and pan bottom are clean. Do not slide glass or metal pans across top. Make sure pan bottom is not rough. Use the recommended cleaning agents. See page 18. • Metal marks. <ul style="list-style-type: none"> - Do not slide metal pans across top. When cool, clean with Cooktop Cleaning Creme. See page 18. • Brown streaks and specks. <ul style="list-style-type: none"> - Remove spills promptly. Never wipe with a soiled cloth or sponge. Make sure cooktop and pan bottom are clean. • Areas with a metallic sheen. <ul style="list-style-type: none"> - Mineral deposits from water and food. Use recommended cleaning agents. See page 18. • Pitting or flaking. <ul style="list-style-type: none"> - Remove sugary boilovers promptly. See page 18.
<p>Moisture collects on oven window or steam comes from oven vent.</p>	<ul style="list-style-type: none"> • This is normal when cooking foods high in moisture. • Excessive moisture was used when cleaning the window.
<p>There is a strong odor or light smoke when oven is turned on.</p>	<ul style="list-style-type: none"> • This is normal for a new range and will disappear after a few uses. Initiating a clean cycle will “burn off” the odors more quickly. • Turning on a ventilation fan will help remove the smoke and/or odor. • Excessive food soils on the oven bottom. Use a self-clean cycle.
<p>Fault Codes</p>	<ul style="list-style-type: none"> • BAKE or LOCK may flash rapidly in the display to alert you if there is an error or a problem. If BAKE or LOCK appear in the display, press CANCEL pad. If BAKE or LOCK continue to flash, disconnect power to the appliance. Wait a few minutes, and then reconnect power. If the flashing still continues, disconnect power to the appliance and call an authorized servicer. • If the oven is heavily soiled, excessive flareups may result in a fault code during cleaning. Press the CANCEL pad and allow the oven to cool completely, wipe out excess soil, then reset the clean cycle. If the fault code reappears, contact an authorized servicer.
<p>Noises may be heard.</p>	<ul style="list-style-type: none"> • The oven makes several low level noises. You may hear the oven relays as they go on and off. This is normal. • As the oven heats and cools, you may hear sounds of metal parts expanding and contracting. This is normal and will not damage your appliance.
<p>There are no beeps and no display.</p>	<ul style="list-style-type: none"> • Control may be in Sabbath Mode. See page 13.

