

Jason International, Inc.  
8328 MacArthur Drive  
North Little Rock, AR 72118  
www.jasoninternational.com  
MADE IN THE U.S.A.



49-1010-201  
Date 05/2014

## OWNER'S MANUAL

# forma<sup>®</sup> and Designer AirMasseur<sup>®</sup> Baths INSTALLATION, OPERATION, AND MAINTENANCE



If the carton shows sign of damage, inspect the product before accepting and describe the problem on the Bill of Lading.

**ALL WARRANTY CLAIMS ON ACRYLIC SURFACE DAMAGE MUST BE MADE PRIOR TO INSTALLATION.** Inspect plumbing and bath surface for missing or damaged components. Alert your dealer of any discrepancies.

To protect the unit from damage, keep the bath in the carton until ready for installation.

### INSPECTION

**Inspect the unit prior to installation. In the event of a problem, DO NOT install the unit.**

All components are factory assembled to the bath and the unit is water tested and inspected prior to leaving Jason International, Inc.

If the carton shows sign of damage, inspect the product before accepting and describe the problem on the Bill of Lading.

**NOTE: Transportation and insurance from Jason's factory are the buyer's responsibility.**

**Damage sustained in transit is the responsibility of the carrier.** If damage is discovered, the carrier must be immediately notified in writing with a request for a representative to inspect the unit. Failure of the carrier to respond should be reported to the seller and carrier. Always file a freight claim promptly.

The installer is responsible for insuring that the unit is free from defects or shipping damage. **In the event of a problem, DO NOT install the unit.**

Jason International is not responsible for damage that might have been avoided by inspection or testing prior to installation.

Damage to the unit during installation will not be covered by warranty and is the responsibility of the installer.

### EQUIPMENT ACCESS

In accordance with Building Codes, service access to all hydrotherapy bath equipment, controls and electrical connections must be provided during installation **(Recommended minimum 28" x 17" [71 x 43 cm])**. Insufficient access will hinder repair and maintenance. Warranty service will not cover costs of providing equipment access.

Jason offers an optional removable lateral skirt for all rectangular baths. The skirts are available in matching acrylic colors and provide convenient access to bath equipment, as well as an excellent finished appearance.

The Specification Sheet for this bath contains additional technical information. This sheet can be provided by your dealer or accessed online at [www.jasoninternational.com](http://www.jasoninternational.com).

### OWNER'S RECORD

Dealer: \_\_\_\_\_

Date Purchased: \_\_\_\_\_

Date Installed: \_\_\_\_\_

Installer: \_\_\_\_\_

**PLACE SERIAL NUMBER CARD WITH  
PRODUCT CONFIGURATION IN THIS BOX**



# INSTALLATION INSTRUCTIONS

## INSTALLATION

See the **USER MAINTENANCE INSTRUCTIONS** section of this owner's manual, prior to Installation, for humidity and mold prevention suggestions.

1. **Finish Frame.** A finish frame under the shell rim should also always be constructed to support the bath deck and insure proper drainage toward the bath well. This frame is not intended to support the full bath weight (see **Figures 1 & 2**).

Jason offers a removable lateral skirt for most baths. The skirts are available in matching acrylic colors and provide convenient access to bath equipment as well as an excellent finished appearance. However, if Jason's lateral skirt is not used, an access panel **MUST** be provided to enable final electrical connections and service.

If a Jason lateral skirt is to be used, the bath deck must be leveled at 20.5" (52cm) from the support floor or the skirt will not fit properly.

**Allow ample clearance for the equipment.**

**CAUTION:** Ambient temperature under the bath where equipment is installed must not exceed 122°F (50°C).

2. 100% Silicone with mildew resistant properties should be applied between the water resistant backer board and the deck of the bath.

**NOTE:** If you use a tile flange kit, modify the framing to support the bath lip as shown in **Figure 1**.

3. A minimum ventilation opening of 2" x 4" (5 x 10 cm) for the blower is required, and should be designed to draw in indoor ambient air at a minimum of 22°C (72°F).
4. Install the drain and overflow assembly to the bath shell according to the instructions provided with the drain and position the bath in the area of intended installation.
5. Finish plumbing rough-in of drain and overflow assembly. At this time, considerations should be made for the position and mounting of the faucet set, as well as all related plumbing.

**Figure 1**

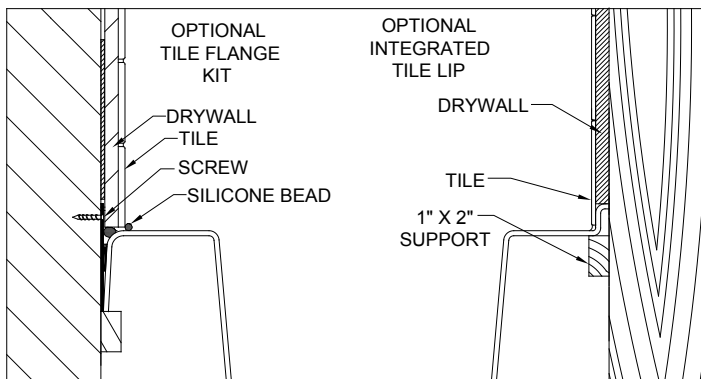

**Figure 2**

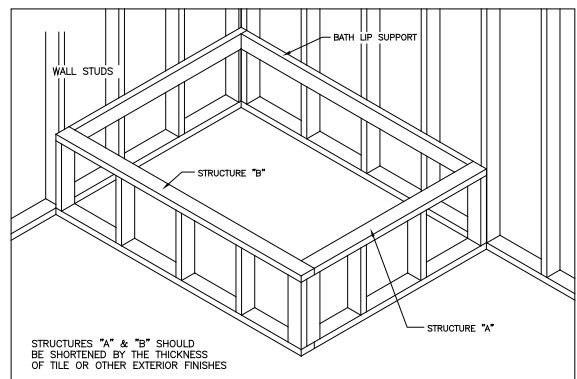

6. **Remove the packing board before installing the bath.** The bath is equipped with separate bath equipment support bases which are joined for shipment with packing boards. Detach the packing board from the bath and from underneath the equipment.
  - WARNING: Any modification to the equipment is not recommended and will void the Manufacturer's warranty.**
  7. **Install the bath level for proper drainage.** Jason baths are designed to be supported at the base of the bath. If the floor is smooth and level, the baths' Level Form™ Base will provide proper drainage and support (**See Figure 3**).
  8. Mortar is required when the subfloor is not smooth and level; when additional sound insulation is desired; or when the bath is installed in a drop-in application. In alcove installations, a bed of mortar may also be recommended to aid in leveling the bath.
9. **Secure the bottom of all equipment mounts so that it is level with the bottom of the bath.** Position the bath in the area of intended installation and cut the equipment support strap(s) to allow the equipment to rest firmly on the floor. We recommend securing the equipment mounts to the floor with removable fasteners for ease of servicing.
  10. **Protect the acrylic bath surface from damage during installation with a suitable material, i.e., cardboard and/or plastic film.** The acrylic surface of this bath has been provided with a protective film which helps protect the bath during shipment and installation. Additional protection may also be required to protect the acrylic surface during installation. If the bath is tiled in, remove the necessary portion of the film when installing the tile.

**NOTE:** Do not use a sand bed to install or level the bath.

**Figure 3**

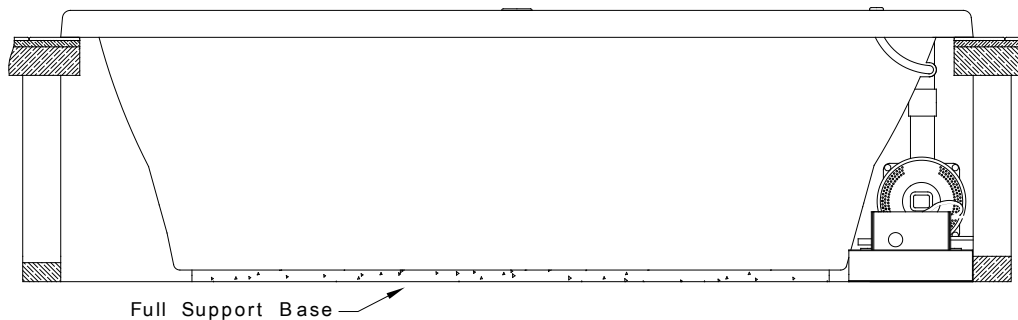

## REMOTE MOUNTING OF AIR BLOWER

The Jason AirMasseur system has been factory installed following E.T.L. Guidelines. During installation, if remote mounting of the blower is desired or required, the following procedures should be followed.

**NOTE: Do not remote mount the blower more than 15 feet (457cm) away from the air inlet of the bath. Choose a location as close as possible to the bath to assure maximum efficiency.**

1. The installer must determine the layout of the piping; exact remote mount location; and service access before beginning any work. Use 1.5" (38mm) ABS or PVC plastic tubing. Locate the blower in an area accessible for servicing.

**NOTE: A 15 foot extension replacement cable set can be purchased from your Jason supplier, if needed. To insure proper functioning of the system, avoid remote mounting in a location which requires more than six (6) piping direction changes. A 90° direction change should be made up of two 45° elbows for maximum efficiency.**

2. If the blower has been factory installed, disconnect the blower from the air bath plumbing by removing the two (2) screws on the check valve outlet and disconnect the short piece of flex pipe between the check valve and the elbow by removing the two (2) screws in the elbow. (Omit this step on baths where the blower is not factory installed and remote mounting is required.)
3. Install the blower in the remote location. The remote mount locations' ambient air temperature should remain at approximately 22°C (72°F) for optimum air heating.
4. Make sure the blower is well ventilated. The blower mount should be attached firmly to the floor. Piping between the remote blower location and the bath can be insulated using a minimum of 1/2" (13mm) thick insulation. Attach new piping to the elbow of the existing piping.

## ELECTRICAL

**Electrical Power Supply:** These instructions are written assuming 60Hz, 120V power supply. Special notations are also included for the Export versions of the control equipment, and power supply.

**WARNING:** Verification of electrical requirements **MUST** be made before installation. Refer to the equipment labels for voltage and frequency requirements.

**NOTE:** The bath is designed for indoor use only. The electrical equipment must not be exposed to direct or indirect water or moisture contact. The electrical equipment must also be protected from dust and other airborne debris before, during, and after installation.

- 1. Electrical Service:** A licensed electrician must provide the “dedicated” electrical service protected by a GFCI. The location of the GFCI must be at least five (5) feet (152 cm) away from the inside surface of the bath, accessible for regular testing. Use copper conductors only.

**DANGER — RISK OF ELECTRIC SHOCK:** Connect only to a circuit protected by a Ground Fault Circuit Interrupter (GFCI). In the unlikely occurrence of a current imbalance in the power conductors, the GFCI will interrupt the power to the bath.

**WARNING:** The electrical service to the GFCI must not be interrupted by any control device. Likewise, the electrical service from the GFCI to the bath control should be direct and not interrupted by a switch. Never use a switch in conjunction with a control device. This will VOID THE MANUFACTURER’S WARRANTY.

## 2. GROUNDING IS REQUIRED

The unit should be installed by a qualified service representative and properly grounded.

## 3. INSTALL SERVICE CONNECTION AT LEAST 6” (15cm) ABOVE SUB FLOOR.

**ALL LOCAL AND STATE ELECTRICAL AND PLUMBING CODES MUST BE OBSERVED.** Where there are no local codes, the **National Electric Code (NEC)** and **Uniform Plumbing Code (UPC)** shall be observed.

It is the responsibility of the installer/owner to determine specific code compliance prior to installation of the product.

**NOTE:** In the Commonwealth of Massachusetts, installation is to be done by a Massachusetts licensed plumber.

## 4. 120V Electrical Service - AirMasseur® Control Box.

The blower is prewired to the control box. The control box has a 36” (91cm) cord with plug end. The blower control box is mounted on a stand that is temporarily secured to the packing board for shipping. During installation, the control box bracket and controls must be positioned horizontally and located to permit access for inspection and servicing. The blower control must be plugged into a dedicated 120V, 15A, 60Hz, GFCI protected circuit. (See Figure 4)

## 5. 240V Electrical Service - AirMasseur® Control Box (Export).

The blower is prewired to the control box. The control box has a 36” [91 cm] cord with a junction box connection. The blower control box is mounted on a stand that is temporarily secured to the packing board for shipping. During installation, the control box bracket and controls must be positioned horizontally and located to permit access for inspection and servicing. The blower control must be connected into a dedicated 240V, 15A, 50 or 60Hz, GFCI protected circuit. (See Figure 4)

**DANGER:** Do not alter the factory installed wiring. All building materials and wiring should be routed away from the equipment or other heat-producing components of the unit.

Figure 4



**Standard / Premier Edition**



**Signature Edition**

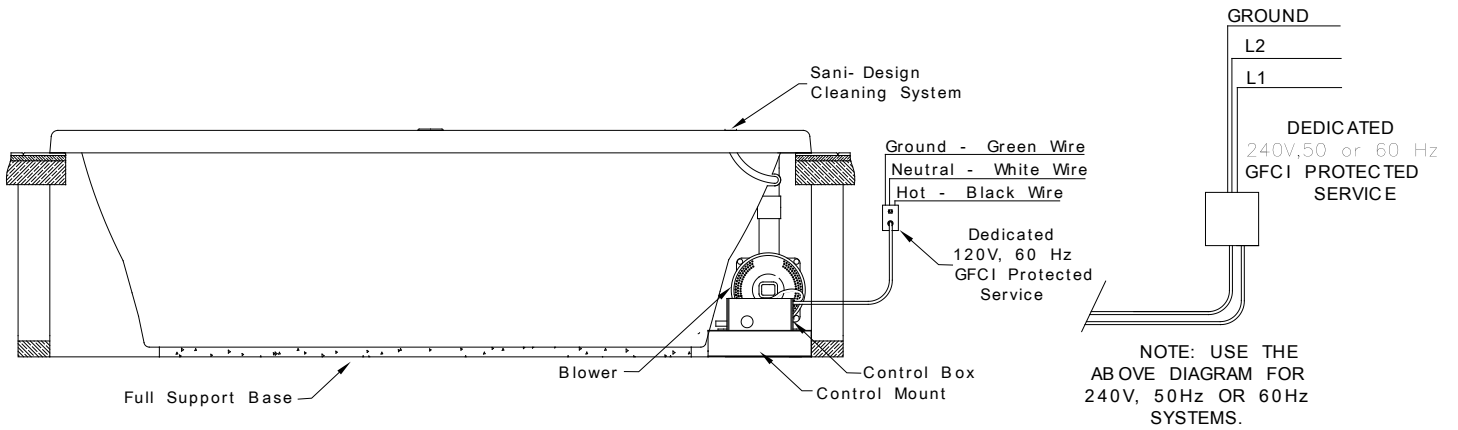

## CLEANING

1. **Remove all loose debris.** Construction plaster or excess grout can be removed with the use of a wood (edge) trowel.
2. **Paint or tar stains** may need to be removed with a cleaner such as paint thinner, turpentine, or isopropyl alcohol (rubbing alcohol). Never allow the cleaner to soak against the acrylic surface for long periods of time. Always rinse the surface immediately following the use of cleaners.
3. Follow the manufacturer's instructions for safe use of cleaning products. If the surface becomes scratched or dulled, it may be restored by using a quality plastic polish, like Novus Plastic Polish No. 2 (available from the Jason Dealer). **It is always preferable to protect the acrylic surface during installation to minimize cleanup and prevent surface damage.**

## WATER TESTING

Before finishing the installation, it is recommended that the bath be water tested and the plumbing tested for leaks.

1. **Before water testing the bath,** make sure any pump unions are hand tight. Do not over tighten or use a pipe wrench. This will damage the unions and cause leaking. If the unit leaks with the unions hand tight, then loosen the unions(s) and check the O-ring seal to ensure it is properly seated.
2. **Fill and operate the bath.** Close the drain and fill the bath with water to at least 10 inches [25 cm] below the bath deck. The inlet temperature should not exceed 40°C (104°F). Refer to the **FILLING AND DRAINING** section of this owner's manual for more information.
3. **Inspect the plumbing for leaks.**
4. **Turn the equipment Off and then drain the water.** The bath unit and its plumbing are designed to drain after each use whether used as a hydrotherapy bath, soaking bath, or when taking a shower.

# AIRMASSEUR® CONTROL BOX CONNECTIONS

## STANDARD EDITION AIRMASSEUR®

Jason's Standard Edition AirMasseur® system features the best in luxury bathing for the leisure bath industry. To assure that your bath functions properly the blower control must be properly connected.

**NOTE: For 120V systems, the power cord for the blower control box must be plugged into a 120V, 15 amp GFCI dedicated circuit.**

### The AirMasseur® Control Box

The blower and keypad must be plugged into the proper receptacles for correct operation of the AirMasseur® system. See **Figure 5** for connections:

- (A) The power cord for the AirMasseur® control box must be connected into the proper GFCI dedicated circuit for the system (see note).
- (B) The blower's power cord will need to be plugged into the control box. Refer to the **ELECTRICAL** section of this manual for connecting the pump to the control box.
- (C) Eight-pin mini-DIN terminal for the AirMasseur® Keypad.

Figure 5

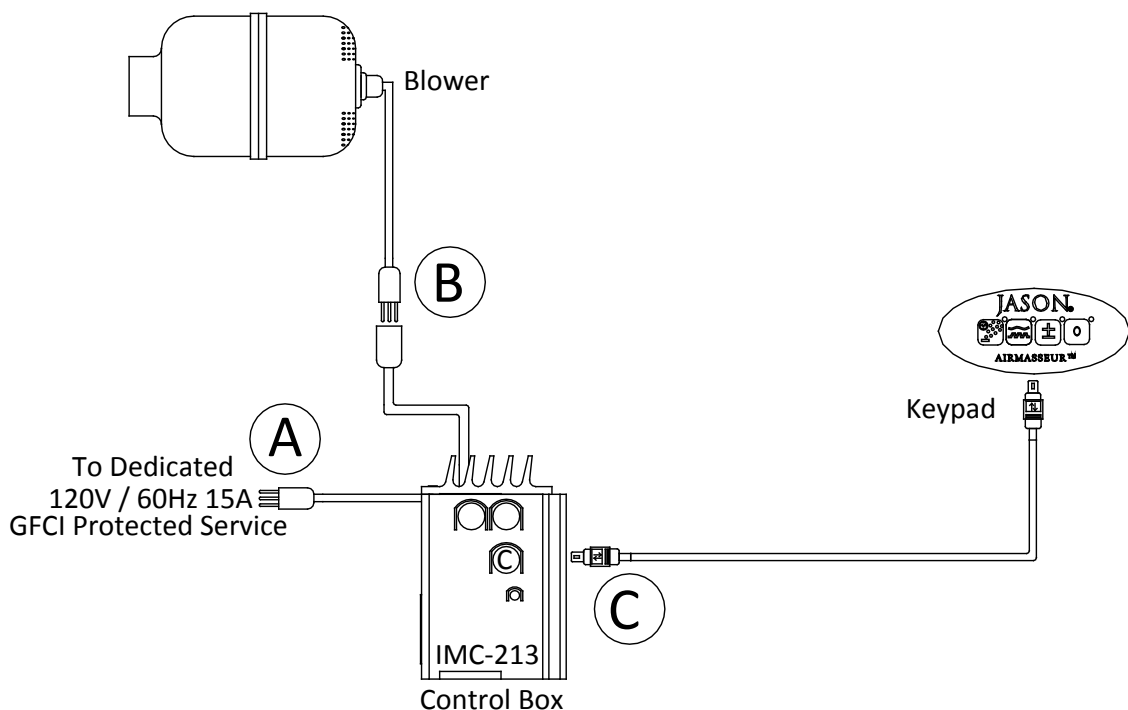

**NOTE:** This diagram also applies to 50 Hz, 240V controls, and power supply systems. Except that the Blower junction box must be connected into one dedicated 240V, 15 amp, GFCI circuit.



**PREMIER EDITION AIRMASSEUR®**

Jason's Premier Edition AirMasseur® system incorporates all the features of the Standard Edition system and includes the benefits of ozone sanitation system, and an LED Chromatherapy light. To assure that your bath functions properly, the blower control box must be properly connected.

**NOTE: For 120V systems, the power cord for the blower control box must be plugged into a 120V, 15 amp GFCI dedicated circuit.**

**The AirMasseur® Control Box**

The blower, keypad, LED light, and Ozone Sanitation Unit must be plugged into the proper receptacles for correct operation of the AirMasseur® system. See **Figure 6** for connections:

(A) The power cord for the AirMasseur® control box must be connected into the proper GFCI dedicated circuit for the system (see note).

(B) The blower's power cord should be plugged into the female cord connection on the ozone unit, prewired to the control box.

(C) Eight-pin mini-DIN terminal for the AirMasseur® Keypad.

(D) Six-pin mini-DIN terminal for LED light.

**Figure 6**

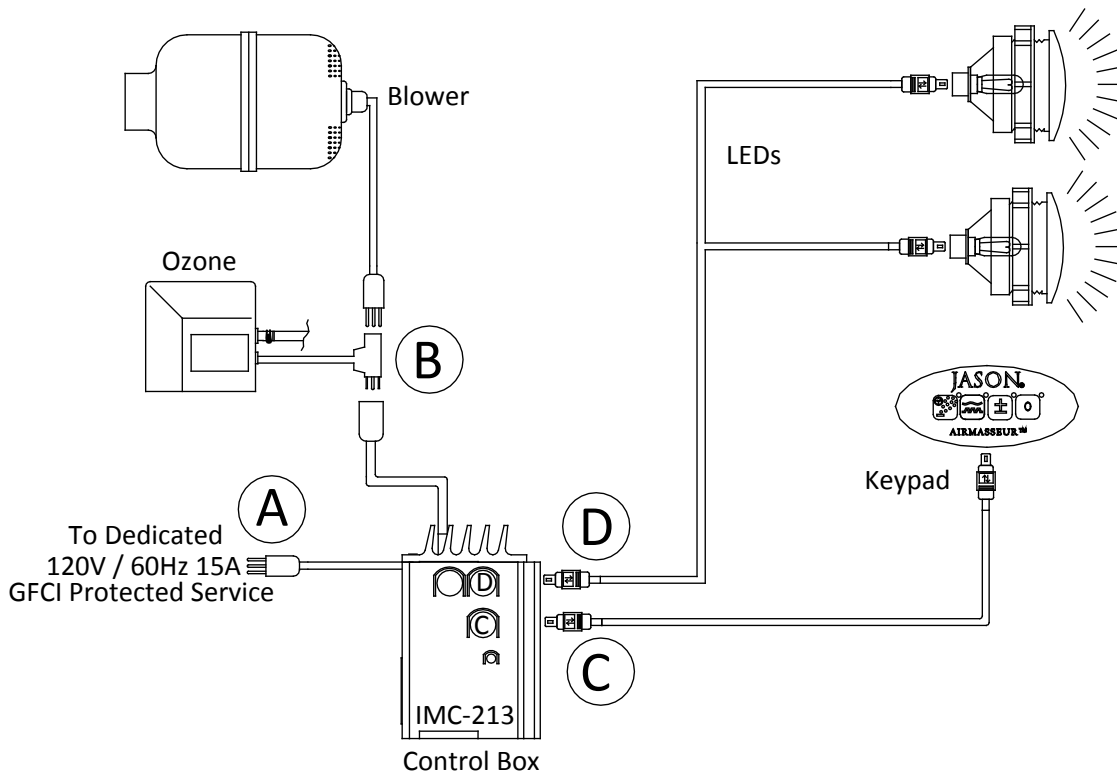

**NOTE:** This diagram also applies to 50 Hz, 240V controls, and power supply systems. Except that the Blower junction box must be connected into one dedicated 240V, 15 amp GFCI circuit.

## SIGNATURE EDITION AIRMASSEUR®

Jason's Signature Edition AirMasseur® system is the most advanced bath manufactured by Jason International, Inc. and features the ultimate in luxury bathing for the leisure bath industry. The blower control box must be properly connected for the bath to function correctly.

**NOTE: For 120V systems, the power cord for the blower control box must be plugged into a 120V, 15 amp GFCI dedicated circuit.**

Figure 7

### The AirMasseur® Control Box

The blower, keypad, LED light, Ozone Sanitation Unit and Water Level/Temperature Sensor must be plugged into the proper receptacles for correct operation of the AirMasseur® system. See **Figure 7** for connections:

- (A) The power cord for the AirMasseur® control box must be connected into the proper GFCI dedicated circuit for the system (see note).
- (B) The blower's power cord should be plugged into the female cord connection on the ozone unit, prewired to the control box.
- (C) Eight-pin mini-DIN terminal for the AirMasseur® Keypad.
- (D) Six-pin mini-DIN terminal for LED light.
- (E) Six-pin mini-DIN terminal for installation of the water sensor to the control box.

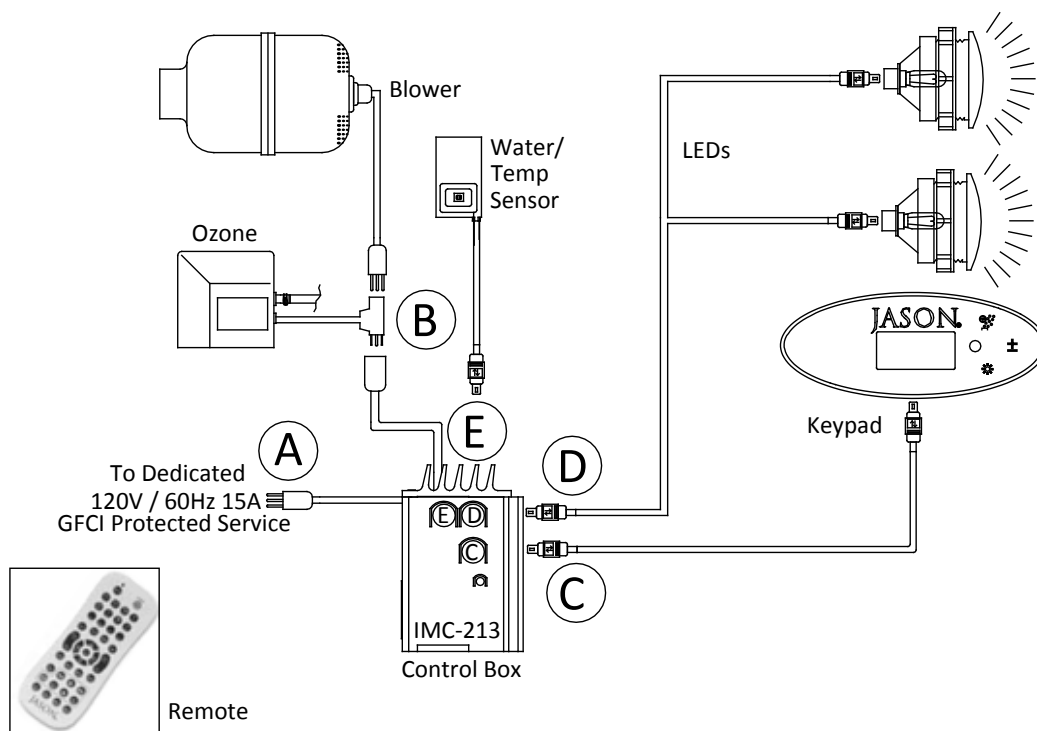

**NOTE:** This diagram also applies to 50 Hz, 240V controls, and power supply systems. Except that the Blower junction box must be connected into one dedicated 240V, 15 amp GFCI circuit.

# OPERATING INSTRUCTION, FEATURES, AND CONTROLS

## INTRODUCTION

This manual contains all information needed for the proper installation and operation of your Jason AirMasseur® bath. The AirMasseur® bath has been designed to give you years of relaxing trouble-free service, provided the unit is maintained and operated in accordance with these instructions.

Thoroughly clean and disinfect the unit as described in the **CLEANING** section of the **USER MAINTENANCE INSTRUCTIONS** section of this owner's manual before its first use and periodically thereafter.

All Jason AirMasseur® baths are pre-plumbed at the factory.

**WARNING: Before operating refer to the instructions at the end of this owner's manual pertaining to the risk of fire, electric shock, or injury to persons.**

## FEATURES AND CONTROLS

### STANDARD AND PREMIER EDITION AIRMASSEUR®

The Jason Standard Edition AirMasseur® bath includes a variable-speed, 1-HP air blower with heater, automatic purge cycle; and three (3) massage modes: Continuous, Wave, or Pulse; an electronic control; and a 20-minute timer.

The Jason Premier Edition AirMasseur® bath provides all the features of the Standard Edition with the included benefits of a LED Chromatherapy Mood Light, and an Ozone Sanitation system.

#### Standard/Premier Touchpad

One main control touchpad mounted on the bath deck contains several icons used by the bather to control the blower, and LED mood light. A built in timer shuts the blower off 20 minutes after being activated.

#### Standard/Premier Automatic Purge

Fifteen (15) minutes after the control has shut off, the blower will start again for a two-minute purge cycle that dries the air channel. Note that the blower light will flash during the 15-minute pause before the purge cycle begins. Once the purge cycle begins, all indicators will light and the keypad operation will be disabled for two (2) minutes.

### SIGNATURE EDITION AIRMASSEUR®

The Jason Signature Edition AirMasseur® bath includes a variable-speed, 1-HP air blower with heater, automatic purge cycle; and three (3) massage modes: Continuous, Wave, or Pulse; Chromatherapy mood light, Automatic Ozone System that will be operated any time the blower is powered; a digital control with LCD display window; low water and temperature sensors; and a 20-minute timer.

#### Signature Touchpad

A main control touchpad mounted on the bath deck features a LCD readout which alternately indicates the water temperature (+/- 5°F) and time remaining. The Signature Edition touchpad allows the bather to control the blower and LED mood light. A built in timer shuts the blower off 20 minutes after being activated.

#### Signature Automatic Purge

Twenty (20) minutes after the control has shut off, the blower will start again for a two minute purge cycle that dries the air channel. Note that the LCD display will read "PURGE" and begin to countdown the 10 or 20 minute pause before the purge cycle begins. The readout will display "PURGE ON" during the purge cycle. Any time during the pause before the purge cycle begins, pressing and holding the Blower Speeds icon will reduce the pause from 20 minutes to 10 minutes. During the two-minute purge, pressing the "Blower On/Off" icon will stop the purge.

#### Signature Daily Purge

The daily purge can be activated through the customized settings of the Signature Edition touchpad. When activated, the daily purge will start the blower for two-minutes at the same time every day to dry the air channel. See 'Operating the Signature Edition AirMasseur Touchpad' section for details on activating this setting.

#### Signature Remote Control

In addition to the main control touchpad installed on the bath deck, a floating, waterproof Universal Remote Control is provided with all Signature Edition AirMasseur® baths. This remote control provides the same control functions as the bath's main control console, plus the bather may remotely operate a TV, DVD, VCR, CD, etc. Refer to the Instruction Manual provided with the remote control for detailed instructions.

**Blower**

The blower generates warm air and pushes it through the air jets. Blowers provided on Jason AirMasseur® baths are factory tested when assembled and again retested after installation on the bath.

**Filling And Draining**

Close the drain and fill the bath with water to desired level. The inlet temperature should not exceed 40°C (104°F). When bath is in use, turn the unit Off before draining the water. The bath unit and its plumbing are designed to drain after each use whether used as a hydrotherapy bath, soaking bath, or just taking a shower.

**NOTE:** If the unit fails to operate, check the breaker panel to insure that the circuit breaker is on. Check the GFCI by testing and resetting it. If the unit still fails to operate, refer to the Trouble Shooting Guide section of this owner's manual. If the unit still fails to operate and is out of warranty, contact an authorized service technician for repair. If the unit is within the warranty period, contact JASON Technical Services at 800-255-5766. **DO NOT ATTEMPT TO RESOLVE THE PROBLEM.**

## STANDARD EDITION AIRMASSEUR® TOUCHPAD

Figure 8

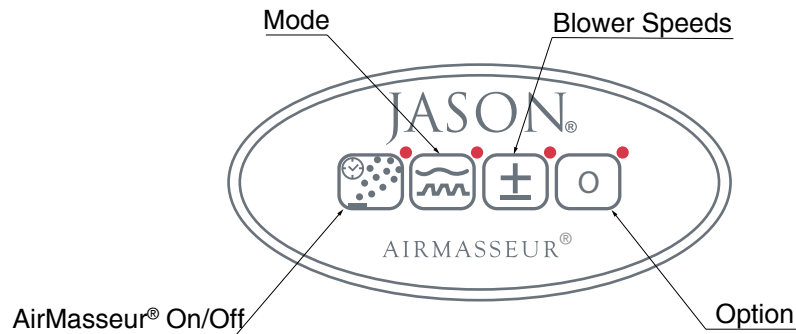

### OPERATING INSTRUCTIONS

#### AirMasseur® Icon

The AirMasseur® icon is used to activate the blower and the 20-minute timer.

- Pressing the icon once starts the blower in the Constant high speed mode.
- Pressing the icon again will turn the blower off.

**Note:** The blower will always turn on in high speed.

#### Mode Icon

The Mode icon is used to move the blower from Constant mode to the Wave or Pulse modes.

- Press and release the icon once to change the blower to the Wave mode, indicated by a slow flashing light.
- Pressing the icon again will change the blower to Pulse mode. This is indicated by a rapid light flash.
- Pressing the icon a third time moves the blower back to Constant mode.

#### Blower Speeds Icon

The Blower Speeds icon is used to increase or decrease the blower speed once the blower is On.

- Press and hold the icon to decrease the blower speed until the desired intensity is reached, then release.
- Press and hold the icon again to increase the blower speed until the desired intensity is reached.

The blower will return to its highest speed on any mode change.

#### Option

The Option icon is used to operate an optional LED light (if installed).

- Press the icon for less than two (2) seconds to turn the lights Off or On.
- Hold the icon for more than two (2) seconds to change modes.

This function has a two (2) hour timer and remembers the last mode.

## SIGNATURE EDITION AIRMASSEUR® TOUCHPAD

Figure 9

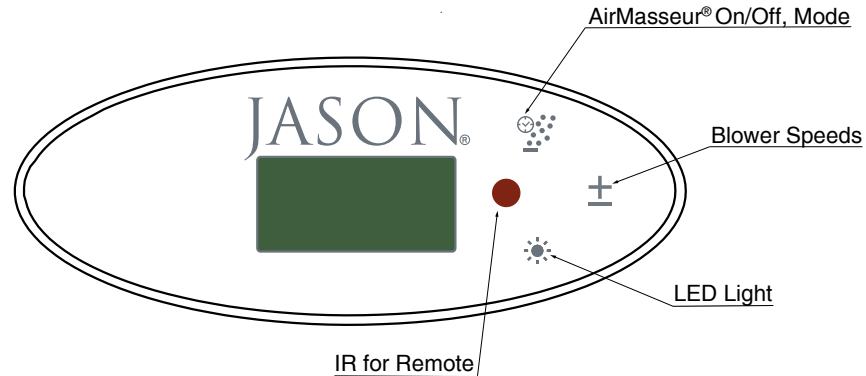

### OPERATING INSTRUCTIONS

#### AirMasseur® On/Off and Mode Icon

To control the operation of the blower, simply press and release to change the setting to Constant, Wave, Pulse or Off. A 20 minute decreasing timer will be initiated when the blower motor starts. Press and hold the Blower icon to cycle through blower modes. The Blower icon should remain lit as long as the bath is connected to a power supply. The LCD will display “Const Air” and blower speed, “Wave Air” and blower speed, or “Pulse Air” and blower speed, while the key is pressed. The time remaining on the purge cycle is displayed after the bath has drained. “Purge Stop” is displayed while the key is pressed during the purge cycle. This action will terminate the purge cycle. The mode settings will be remembered on the next startup.

#### Blower Speeds Icon

Hold the key in Constant mode to go from High to Low then release and hold again to go from Low to High. Hold the key in Wave and Pulse mode to go from High to Medium and Medium to High. The system remembers the last speed setting on the next startup. The Blower Speeds icon will light up when the blower is running. The LED displays the blower speed from “10” (Low) or “55” (Med) to “99” (High) while the key is pressed. You can reduce the auto purge idle time from 20 minutes to 10 minutes, by pressing and holding the key for more than 5-seconds during the purge idle period.

#### LED Light Icon

Hold the icon for less than two (2) seconds to turn the lights Off or On. Hold the icon for more than two (2) seconds to change modes. The Light icon should remain lit as long as the bath is connected to a power supply. This function has a two (2) hour timer and remembers the last mode. The LCD displays “Light On” or “Light Off” while the icon is pressed for less than two (2) seconds. “Light Cycle” is displayed if pressed for more than two (2) seconds.

### Customized Settings

The 12 character LCD display can be customized by pressing the AirMasseur® and Blower Speeds icons simultaneously for five (5) seconds, while the system is Off. **Note:** The Blower Speeds icon will not be illuminated during this process. Use the above figure to locate the icon. A menu will be displayed to choose the following: Purge 24, (starts the blower every 24 hours for two (2) minutes at the time the purge was set); Product Test Diagnostics; Temperature (Fahrenheit or Celsius); and Language (English or Spanish).

### Menu Instructions

Use the AirMasseur® icon to scroll through the different menu items. Use the Blower Speeds icon to change an option. For example, press and release the AirMasseur® icon to change from Purge 24 to Product Test; press and release again to arrive at the Temperature option. Then press and release the Blower Speeds icon to change the temperature display from F (Fahrenheit) to C (Celsius).

### Product Test Diagnostics

After selecting the Product Test option from the menu, the unit will perform a series of tests to confirm correct installation of components. The test will begin by displaying the configuration number, followed by the software revision number. Next, the display will test the Temperature and Low Water Level sensor (ITW-209). Next, each of the six (6) icons will begin to light. Press the illuminated icon to proceed to the next icon. After the icon test, the blower will start for two (2) seconds on the High setting. Lastly, the LED Light unit will be tested. If you receive an error on any of the tests, confirm proper installation of the component to the correct control box. (See the **CONTROL BOX CONNECTIONS** section).

### Remote Control

The Signature Edition control system includes a waterproof floating Universal Remote Control. It controls all bath functions plus a TV, DVD, CD, etc. which can be heard through the optional Sound Immersion Transducers (optional).

# USER MAINTENANCE INSTRUCTIONS

---

## HUMIDITY

**WARNING: Avoid high humidity levels in your home. Mold, mildew, fungi and bacteria which may be harmful to health thrive in areas with continued high humidity levels; therefore, every precaution should be taken to make sure your plumbing fixtures including bathtubs, therapy baths, or showers do not become a source of high humidity due to improper installations or leaks.**

To avoid having your plumbing fixtures become a source of unwanted humidity, please make sure the following steps are taken prior to installation.

1. Make sure the area where the bathtub or shower is installed is well vented and allows enough ventilation and air circulation to dry the bathroom environment within a short time after taking a bath or shower.
2. If your bath or shower unit is tiled-in, use units with an integral tile flange or make sure a tile flange kit or a similar mechanical barrier is installed to prevent shower spray, splash, or overflow to leak behind the bathtub.
3. Make sure the plumber properly tests your therapy bath before it is roughed in to make sure there are no leaks and it is installed with proper access to bath equipment.
4. Make sure that all the plumbing and fixtures in the bathroom are in good working order and have no leaks.
5. Do not use carpeting or other materials or furniture, which can hold moisture in your bathroom.
6. Use disinfectant to clean any bathroom surfaces which are regularly exposed to moisture.
7. Clean and disinfect humidifier and dehumidifiers as recommended by the manufacturer. Replace the air filter on the HVAC unit once a month.
8. Clean moldy surfaces as soon as any mold appears by using a detergent/soapy solution and appropriate household cleaner. Always use gloves during cleaning. Dispose of any sponges or rags used to clean mold.

## CLEANING

With minimum care, your acrylic-surfaced bath will retain its high-luster finish for many years. For regular cleaning use Jason Bath Cleaner or a mild **NONABRASIVE** liquid detergent solution (i.e. glass cleaner) and a soft, wet cloth or sponge. Do not run the hydrotherapy system with foaming cleaners or soaps. Rinse the bath thoroughly after cleaning.

## SURFACE MAINTENANCE

Areas with minor scratches or dull surfaces can be restored by applying commercially available plastic polish (i.e. Novus Plastic Polish No. 2, available at your Jason dealer), followed by an application of acrylic paste wax. Buff the surface with a clean soft cloth. Do not use sandpaper, steel wool, or abrasive rubbing compounds. If scratches are too deep to rub out, or if the damage penetrates the acrylic surface, consult your dealer for recommendations on surface repair.

## AIR HEATER AND AIR TEMPERATURE

The air heater incorporated into the air blower is designed to preheat the incoming air to body temperature, not to heat the bath water. The air heater automatically comes on when the air blower is activated. Even though all air baths provide preheated air, occasionally some people with sensitive skin might experience a cold air sensation. This sensation is caused by the swiftly moving heated air bubbles blowing on the wet skin. This phenomenon can be related to the use of a fan for cooling on a hot day. While the ambient temperature does not change, the moving air makes you feel cooler. Avoiding this cold air sensation is among the reasons Jason avoids placing air jets directly beneath the body. If you experience a cool air sensation, which is most noticeable during the first few minutes of an air bath, simply move your body slightly away from the closest jets.

## FLUSHING / SANITIZING

Upon start-up and not to exceed 90 days, your bath and plumbing system should be flushed. To do so, close the drain and fill the bath with warm water to at least two (2) inches [5.1 cm] above the highest jet. Pour in Jason Bath System Cleaner and follow the directions on the bottle. **DO NOT** use bleach or other chlorinated cleansers directly on the metal trim.

## REPAIR

Refer all plumbing or electrical repair to a qualified service technician. **DO NOT ATTEMPT TO RESOLVE THE PROBLEM.** This can result in danger of electrical shock or damage to the unit and will **VOID THE WARRANTY.** Remember, when contacting your dealer or service representative, always have your serial number, proof of purchase, and model number. This will insure a quick response on warranty items. The serial number can be found on the front page of this manual or on the small card adhered to the back of the bath just above the equipment.

**ALL WARRANTY REPAIRS MUST BE AUTHORIZED BY THE MANUFACTURER BEFORE WORK IS STARTED.**

# TROUBLE SHOOTING GUIDE

If you believe the unit to be within the warranty period, you must contact **Jason Customer Service: 1-800-255-5766** with the bath's Product and Serial numbers before work is started.

**ALL WARRANTY REPAIRS MUST BE AUTHORIZED BY JASON BEFORE WORK IS STARTED.**

FOR SERVICE, ALWAYS CONTACT YOUR DEALER OR AUTHORIZED SERVICE CENTER

**WARNING: Always turn off power at the main electrical service panel when servicing the bath.**

<b>AIRMASSEUR® BLOWER SYSTEM</b>		
<b>SYMPTOMS</b>	<b>POSSIBLE CAUSES</b>	<b>RECOMMENDED ACTION</b>
Air bath system won't operate.	a) No power to air bath unit.	a) Reset circuit breakers and check GFCI. Check fuses and replace if bad.
	b) Blower motor is not plugged in.	b) Make sure plug is fully inserted into the outlet.
	c) Keypad is disconnected.	c) Check and reconnect if necessary.
Blower shuts off by itself or before time elapses.	a) Blower motor overheated and thermal protection device deactivated motor (possibly low voltage).	a) Check that blower has sufficient ventilation and that the intake into the blower is not blocked. Clear and allow the motor to cool down. (Check service & wire size.)
	b) GFCI tripped.	b) Refer to installer/dealer.
Circuit breaker trips repeatedly.	a) Defective breaker.	a) Replace breaker.
	b) Short circuit between bath and blower breaker box.	b) Refer to installer/dealer.
	c) Other items are connected to the same circuit.	c) Refer to installer/dealer.
Blower does not shut off.	a) Defective keypad or timer.	a) Refer to installer/dealer. Replace keypad or control.
Air bath does not function properly while in the Pulse or Wave mode (Signature Edition).	a) Blower speed setting is set too low.	a) Change to a mid-range air speed setting before switching over to Wave or Pulse modes.
LED Chromatherapy light will not operate.	a) LED light is loose in socket.	a) Access LED light and assure it is properly installed in socket..
	b) LED cable disconnected.	b) Verify correct cable connections.

**WARRANTY REGISTRATION: Register your product's warranty online at [www.jasoninternational.com](http://www.jasoninternational.com).**

## WARRANTY

Jason International, Inc. (Jason), warrants its baths to be free from defects in workmanship and materials as provided in the enclosed Warranty Statement and Warranty validation card.

The pre-addressed warranty registration card **MUST** be filled out by the purchaser within thirty (30) days from purchase and mailed to Jason International, Inc., in order for limited warranty to become effective.



# IMPORTANT SAFETY INSTRUCTIONS

## **INSTRUCTIONS PERTAINING TO THE RISK OF FIRE, ELECTRIC SHOCK, OR INJURY TO PERSONS.**

This manual contains information and instructions for proper operation and maintenance of your therapy bath. Failure to follow these instructions could result in personal injury, electrical shock, or fire.

**WARNING: When using this unit, basic precautions should always be followed, including the following:**

## **READ AND FOLLOW ALL INSTRUCTIONS CAREFULLY**

### **DANGER: TO REDUCE THE RISK OF INJURY FOLLOW THESE PRECAUTIONS:**

- A. Do not permit children to use this product unless they are closely supervised at all times.
- B. Use this unit only for its intended use as described in this manual. Do not use attachments not recommended by the manufacturer.
- C. The water in a therapy bath should never exceed 40°C (104°F). Water temperatures between 38°C (100°F) and 40°C (104°F) are considered safe for a healthy adult. Use time should be limited to approximately 30 minutes, followed by a shower to cool down. Longer exposures may result in hyperthermia. The symptoms of this condition are nausea, dizziness and fainting, and it can be fatal. Lower water temperatures are recommended for extended use (exceeding 10 -15 minutes) and for young children.
- D. Since excessive water temperatures have a high potential for causing fetal damage during the early months of pregnancy, pregnant or possibly pregnant women should limit therapy bath water temperatures to 38°C (100°F).
- E. The use of drugs or alcoholic beverages before or during therapy bath use may lead to unconsciousness with the possibility of drowning. Never use the therapy bath while under the influence of alcohol, anticoagulants, stimulants, antihistamines, vasoconstrictors, vasodilators, hypnotics, narcotics, or tranquilizers.
- F. Persons with a medical history of heart disease, low or high blood pressure, circulatory system problems, or diabetes should consult a physician before using a therapy bath.
- G. Persons using medication should consult a physician before using a therapy bath since some medication may induce drowsiness while other medication may affect heart rate, blood pressure, and circulation.

**DANGER: To reduce the risk of injury, enter and exit the bath slowly.** Do not operate this unit unless the suction cover is attached over the suction inlet fitting and the jet assemblies are installed. There should be at least two (2) inches of water above the highest jet location during therapy bath operation. **NEVER RUN UNIT DRY.**

**WARNING:** Never operate electrically connected devices in or near the bath. Never drop or insert any object into any opening.

This unit must be connected to a supply circuit that is protected by a GFCI. Such a device should be installed by a licensed electrician and should be tested on a regular basis (at least monthly). To test the GFCI push the **TEST** button. The GFCI should interrupt the power. Push the **RESET** button and the power should be restored. If the GFCI fails to operate in this manner, there is the possibility of an electric shock. **DO NOT USE.** Disconnect the unit and have the problem corrected by a qualified service technician.

To avoid the possibility of personal injury and discoloration of the acrylic surface, the inlet water temperature should not exceed 40°C (104°F). The bath should be drained after each use. Each bather should start their bath with fresh water. Do not use oil base additives in your therapy bath.

**CAUTION:** Do not use harsh abrasives or solvents for cleaning this unit.

**INSTALLER/OWNER BEARS ALL RESPONSIBILITY TO COMPLY WITH ALL STATE  
AND LOCAL CODES WHEN INSTALLING THIS PRODUCT.**

## **SAVE THESE INSTRUCTIONS**

---

# JASON INTERNATIONAL, INC.

8328 MacArthur Drive • North Little Rock • Arkansas • 72118

[www.jasoninternational.com](http://www.jasoninternational.com)