

Use & Care Guide

Microwave Oven

Guía de Uso y Cuidado

Horno de microondas

Mode d'emploi et d'entretien

Four À Micro-ondes



 **Electrolux**

TINSLB003MRR0

Please read and save this guide

Thank you for choosing **Electrolux**, the new premium brand in home appliances. This Use & Care Guide is part of our commitment to customer satisfaction and product quality throughout the service life of your new appliance.

We view your purchase as the beginning of a relationship. To ensure our ability to continue serving you, please use this page to record important product information.

Keep a record for quick reference

Purchase date

Electrolux model number

Electrolux serial number (see picture for location)

NOTE

Registering your product with Electrolux enhances our ability to serve you. You can register online at www.electroluxusa.com or by dropping your Product Registration Card in the mail.

Questions?

For toll-free telephone support in the U.S. and Canada:
1-877-4ELECTROLUX (1-877-435-3287)

For online support and Internet production information visit <http://www.electroluxusa.com>

PRECAUTIONS TO AVOID POSSIBLE EXPOSURE TO EXCESSIVE MICROWAVE ENERGY

- (a) Do not attempt to operate this oven with the door open since open-door operation can result in harmful exposure to microwave energy. It is important not to defeat or tamper with the safety interlocks.
- (b) Do not place any object between the oven front face and the door or allow soil or cleaner residue to accumulate on sealing surfaces.
- (c) Do not operate the oven if it is damaged. It is particularly important that the oven door close properly and that there is no damage to the: (1) door (bent), (2) hinges and latches (broken or loosened), (3) door seals and sealing surfaces.
- (d) The oven should not be adjusted or repaired by anyone except properly qualified service personnel.

Finding Information	2	Auto Cook	18-20
Precautions to Avoid Possible Exposure to Excessive Microwave Energy	2	Auto Cook chart	18-19
Table of Contents	3	Reheat Pasta / Reheat Breads.....	20
Important Safety Instructions	4	Quick Settings	21
Unpacking and Installation Instruction	5	Quick settings chart	21
Grounding Instructions	6	Other Special Features	22-23
Information You Need to Know	7-10	Defrost	22
About your oven	7	Defrost chart.....	22
About microwave cooking.....	7	Keep warm	23
About safety	8	Convenient Features	24-26
About children and the microwave	8	User pref.....	24
About food	9	Multiple sequence cooking.....	25
About utensils and coverings	10	More or less time adjustment	25
Part names	11	Quick Start	25
Control panel	12	Add 30 Seconds.....	25
Before Operating	13	Help	25
To set the clock.....	13	Timer on-off.....	26
Stop/Clear	13	Demonstration mode	26
Manual Operation	14	Cleaning and Care	27
Time cooking.....	14	Service Call Check	28
To set power level.....	14	Specifications	29
Manual defrost.....	14	Warranty Informations	30
Sensor Modes	15-18		
Quick Sensor.....	15		
Quick Sensor chart.....	16		
Sensor Cook.....	17		
Sensor Cook chart	17		

When using electrical appliances basic safety precautions should be followed, including the following:



WARNING

To reduce the risk of burns, electric shock, fire, injury to persons or exposure to excessive microwave energy:

1. **Read all instructions before using the appliance.**
2. Read and follow the specific “**PRECAUTIONS TO AVOID POSSIBLE EXPOSURE TO EXCESSIVE MICROWAVE ENERGY**” on page 2.
3. This appliance must be grounded. Connect only to properly grounded outlet. See “Grounding Instructions” on page 6.
4. Install or locate this appliance only in accordance with the provided installation instructions.
5. Some products such as whole eggs and sealed containers—for example, closed glass jars—are able to explode and should not be heated in this oven.
6. Use this appliance only for its intended use as described in this manual. Do not use corrosive chemicals or vapors in this appliance. This type of oven is specifically designed to heat, cook or dry food. It is not designed for industrial or laboratory use.
7. As with any appliance, close supervision is necessary when used by children.
8. Do not operate this appliance if it has a damaged cord or plug, if it is not working properly or if it has been damaged or dropped.
9. This appliance should be serviced only by qualified service personnel. Contact nearest Electrolux Authorized Servicer for examination, repair or adjustment.
10. Do not cover or block any openings on the appliance.
11. Do not store or use this appliance outdoors. Do not use this product near water—for example, near a kitchen sink, in a wet basement, near a swimming pool, or similar locations.
12. Do not immerse cord or plug in water.
13. Keep cord away from heated surfaces.
14. Do not let cord hang over edge of table or counter.
15. See door surface cleaning instructions on page 27.
16. To reduce the risk of fire in the oven cavity:
 - a. **Do not overcook food. Carefully attend to appliance when paper, plastic or other combustible materials are placed inside the oven to facilitate cooking.**
 - b. Remove wire twist-ties from paper or plastic bags before placing bag in oven.
 - c. **If materials inside the oven ignite, keep oven door closed, turn oven off and disconnect the power cord or shut off power at the fuse or circuit breaker panel.**
 - d. Do not use the cavity for storage purposes. Do not leave paper products, cooking utensils or food in the cavity when not in use.
17. Liquids, such as water, coffee or tea are able to be overheated beyond the boiling point without appearing to be boiling. Visible bubbling or boiling when the container is removed from the Microwave Oven is not always present. **THIS COULD RESULT IN VERY HOT LIQUIDS SUDDENLY BOILING OVER WHEN A SPOON OR OTHER UTENSIL IS INSERTED INTO THE LIQUID.**

To reduce the risk of injury to persons:

 - a. Do not overheat the liquid.
 - b. Stir the liquid both before and halfway through heating it.
 - c. Do not use straight-sided containers with narrow necks. Use a wide-mouthed container.
 - d. After heating, allow the container to stand in the Microwave Oven at least for 20 seconds before removing the container.
 - e. Use extreme care when inserting a spoon or other utensil into the container.
18. If the oven light fails, consult a Electrolux Authorized Servicer.

SAVE THESE INSTRUCTIONS

Unpacking and Examining Your Oven

1. Remove all packing materials from inside the oven cavity. DO NOT REMOVE THE WAVEGUIDE COVER, which is located on the right cavity wall. Read enclosures and SAVE this Use and Care Guide.
2. Remove the feature sticker, if there is one, from the outside of the door.

Check the oven for any damage, such as misaligned or bent door, damaged door seals and sealing surfaces, broken or loose door hinges and latches and dents inside the cavity or on the door. If there is any damage, do not operate the oven and contact your dealer or ELECTROLUX AUTHORIZED SERVICER.

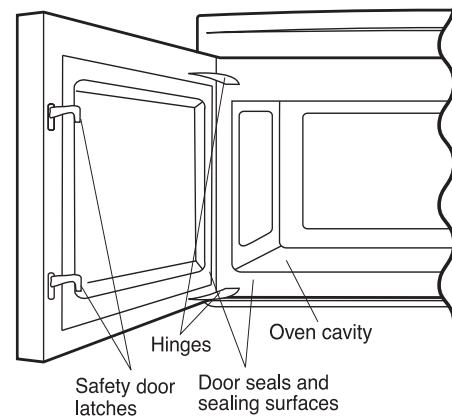

Choosing a Location for Your Microwave Oven

Your oven can be built into a cabinet or wall by itself or above any electric wall oven or warming drawer using built-in kit models EI27MO45T or EI30MO45T for microwave oven model EI24MO45I.

6 GROUNDING INSTRUCTIONS

This appliance must be grounded. This oven is equipped with a cord having a grounding wire with a grounding plug. It must be plugged into a wall receptacle that is properly installed and grounded in accordance with the National Electrical Code and local codes and ordinances. In the event of an electrical short circuit, grounding reduces risk of electric shock by providing an escape wire for the electric current.



WARNING

Improper use of the grounding plug can result in a risk of electric shock.

Electrical Requirements

The electrical requirements are a 120 volt 60 Hz, AC only, 15 amp. or more protected electrical supply. It is recommended that a separate circuit serving only this appliance be provided.

The oven is equipped with a 3-prong grounding plug. It must be plugged into a wall receptacle that is properly installed and grounded. Should you only have a 2-prong outlet, have a qualified electrician install a correct wall receptacle.

A 3-prong adapter may be purchased and used temporarily if local codes allow. Follow package directions.

A short power-supply cord is provided to reduce risk of becoming entangled in or tripping over a longer cord. **DO NOT USE AN EXTENSION CORD.** If the power supply cord is too short, have a qualified electrician or serviceperson install an outlet near the appliance.

NOTES:

1. If you have any questions about the grounding or electrical instructions, consult a qualified electrician or serviceperson.
2. Neither Electrolux nor the dealer can accept any liability for damage to the oven or personal injury resulting from failure to observe the correct electrical connection procedures.

Radio or TV Interference

Should there be any interference caused by the microwave oven to your radio or TV, check that the microwave oven is on a different electrical circuit, relocate the radio or TV as far away from the oven as feasible or check position and signal of receiving antenna.

Permanent and Correct Installation

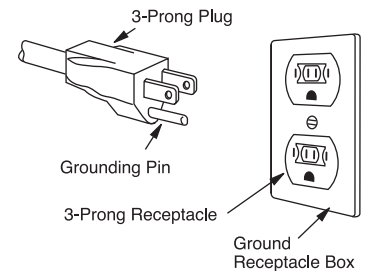

Temporary Use

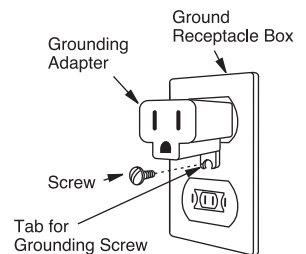

About your oven

This Use and Care Guide is valuable: read it carefully and always save it for reference.

A good microwave cookbook is a valuable asset. Check it for microwave cooking principles, techniques, hints and recipes.

NEVER use the Microwave Oven without the turntable and support nor turn the turntable over so that a large dish could be placed in the oven. The turntable will turn both clockwise and counterclockwise.

ALWAYS have food in the Microwave Oven when it is on to absorb the microwave energy.

When using the Microwave Oven at power levels below 100%, you may hear the magnetron cycling

on and off. It is normal for the exterior of the oven to be warm to the touch when cooking or reheating.

Condensation is a normal part of microwave cooking. Room humidity and the moisture in food will influence the amount of moisture that condenses in the oven. Generally, covered foods will not cause as much condensation as uncovered ones. Ventilation openings must not be blocked.

The Microwave Oven is for food preparation only. It should not be used to dry clothes or newspapers.

Your Microwave Oven is rated 1100 watts by using the IEC Test Procedure. In using recipes or package directions, check food a minute or two before the minimum time and add time accordingly.

About microwave cooking

- Arrange food carefully. Place thickest areas towards outside of dish.
- Watch cooking time. Cook for the shortest amount of time indicated and add more as needed. Food severely overcooked can smoke or ignite.
- Cover foods while cooking. Check recipe or cookbook for suggestions: paper towels, wax paper, microwave plastic wrap or a lid. Covers prevent spattering and help foods to cook evenly.
- Shield with small flat pieces of aluminum foil any thin areas of meat or poultry to prevent overcooking before dense, thick areas are cooked thoroughly.
- Stir foods from outside to center of dish once or twice during cooking, if possible.
- Turn foods over once during microwaving to speed cooking of such foods as chicken and hamburgers. Large items like roasts must be turned over at least once.
- Rearrange foods such as meatballs halfway through cooking both from top to bottom and from the center of the dish to the outside.
- Add standing time. Remove food from oven and stir, if possible. Cover for standing time which allows the food to finish cooking without overcooking.
- Check for doneness. Look for signs indicating that cooking temperatures have been reached.
Doneness signs include:
 - Food steams throughout, not just at edge.
 - Center bottom of dish is very hot to the touch.
 - Poultry thigh joints move easily.
 - Meat and poultry show no pinkness.
 - Fish is opaque and flakes easily with a fork.

8 Information You Need To Know

About safety

- Check foods to see that they are cooked to the United States Department of Agriculture's recommended temperatures.

Temp	Food
160°F	For fresh pork, ground meat, boneless white poultry, fish, seafood, egg dishes and frozen prepared food.
165°F	For leftover, ready-to-reheat refrigerated, and deli and carry-out "fresh" food.
170°F	White meat of poultry.
180°F	Dark meat of poultry.

To test for doneness, insert a meat thermometer in a thick or dense area away from fat or bone. NEVER leave the thermometer in the food during cooking, unless it is approved for microwave use.

- ALWAYS use potholders to prevent burns when handling utensils that are in contact with hot food. Enough heat from the food can transfer through utensils to cause skin burns.
- Avoid steam burns by directing steam away from the face and hands. Slowly lift the farthest edge of a dish's covering and carefully open popcorn and oven cooking bags away from the face.
- Stay near the oven while it's in use and check cooking progress frequently so that there is no chance of overcooking food.
- NEVER use the cavity for storing cookbooks or other items.
- Select, store and handle food carefully to preserve its high quality and minimize the spread of foodborne bacteria.
- Keep waveguide cover clean. Food residue can cause arcing and/or fires.
- Use care when removing items from the oven so that the utensil, your clothes or accessories do not touch the safety door latches.
- Keep aluminum foil used for shielding at least 1 inch away from walls, ceiling and door.

About children and the microwave

Children below the age of 7 should use the microwave oven with a supervising person very near to them. Between the ages of 7 and 12, the supervising person should be in the same room.

The child must be able to reach the oven comfortably; if not, he/she should stand on a sturdy stool.

At no time should anyone be allowed to lean or swing on the oven door.

Children should be taught all safety precautions: use potholders, remove coverings carefully, pay special attention to packages that crisp food because they may be extra hot.

Don't assume that because a child has mastered one cooking skill he/she can cook everything.

Children need to learn that the microwave oven is not a toy. See page 24 for Child Lock feature.

About food

Food	Do	Don't
Eggs, sausages, nuts, seeds, fruits & vegetables	<ul style="list-style-type: none"> • Puncture egg yolks before cooking to prevent “explosion”. • Pierce skins of potatoes, apples, squash, hot dogs and sausages so that steam escapes. 	<ul style="list-style-type: none"> • Cook eggs in shells. • Reheat whole eggs. • Dry nuts or seeds in shells.
Popcorn	<ul style="list-style-type: none"> • Use specially bagged popcorn for microwave cooking. • Listen while popping corn for the popping to slow to 1 or 2 seconds or use special popcorn pad. 	<ul style="list-style-type: none"> • Pop popcorn in regular brown bags or glass bowls. • Exceed maximum time on popcorn package.
Baby food	<ul style="list-style-type: none"> • Transfer baby food to small dish and heat carefully, stirring often. Check temperature before serving. • Put nipples on bottles after heating and shake thoroughly. “Wrist” test before feeding. 	<ul style="list-style-type: none"> • Heat disposable bottles. • Heat bottles with nipples on. • Heat baby food in original jars.
General	<ul style="list-style-type: none"> • Cut baked goods with filling after heating to release steam and avoid burns. • Stir liquids briskly before and after heating to avoid “eruption”. • Use deep bowl, when cooking liquids or cereals, to prevent boilovers. 	<ul style="list-style-type: none"> • Heat or cook in closed glass jars or air tight containers. • Can in the microwave as harmful bacteria may not be destroyed. • Deep fat fry. • Dry wood, gourds, herbs or wet papers.

About utensils and coverings

It is not necessary to buy all new cookware. Many pieces already in your kitchen can be used successfully in your new Microwave Oven. Make sure the utensil does not touch the interior walls during cooking.

Use these utensils for safe microwave cooking and reheating:

- glass ceramic (Pyroceram®), such as Corningware®.
- heat-resistant glass (Pyrex®)
- microwave-safe plastics
- paper plates
- microwave-safe pottery, stoneware and porcelain
- browning dish (Do not exceed recommended preheating time. Follow manufacturer's directions.)

These items can be used for short time reheating of foods that have little fat or sugar in them:

- wood, straw, wicker

DO NOT USE

- metal pans and bakeware
- dishes with metallic trim
- non-heat-resistant glass
- non-microwave-safe plastics (margarine tubs)
- recycled paper products
- brown paper bags
- food storage bags
- metal twist-ties

Should you wish to check if a dish is safe for microwaving, place the empty dish in the oven and microwave on HIGH for 30 seconds. A dish which becomes very hot should not be used.

The following coverings are ideal:

- Paper towels are good for covering foods for reheating and absorbing fat while cooking bacon.
- Wax paper can be used for cooking and reheating.
- Plastic wrap that is specially marked for microwave use can be used for cooking and reheating. DO NOT allow plastic wrap to touch food. Vent so steam can escape.
- Lids that are microwave-safe are a good choice because heat is kept near the food to hasten cooking.
- Oven cooking bags are good for large meats or foods that need tenderizing. DO NOT use metal twist ties. Remember to slit bag so steam can escape.

How to use aluminum foil in your Microwave Oven:

- Small flat pieces of aluminum foil placed smoothly on the food can be used to shield areas that are either defrosting or cooking too quickly.
- Foil should not come closer than one inch to any surface of the oven.

Should you have questions about utensils or coverings, check a good microwave cookbook or follow recipe suggestions.

Accessories

There are many microwave accessories available for purchase. Evaluate carefully before you purchase so that they meet your needs. A microwave-safe thermometer will assist you in determining correct doneness and assure you that foods have been cooked to safe temperatures. Electrolux is not responsible for any damage to the oven when accessories are used.

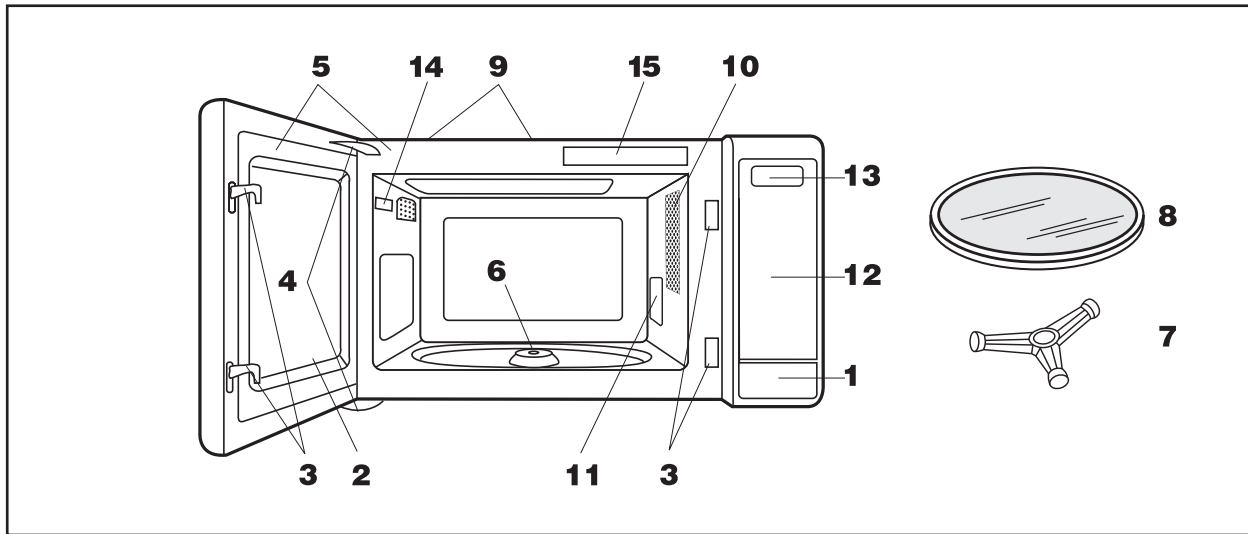

- | | |
|---|---|
| <p>1 One touch door open button
Push to open door.</p> <p>2 Oven door with see-through window</p> <p>3 Safety door latches
The oven will not operate unless the door is securely closed.</p> <p>4 Door hinges</p> <p>5 Door seals and sealing surfaces</p> <p>6 Turntable motor shaft</p> <p>7 Removable turntable support
Carefully place the turntable support in the center of the oven floor.</p> | <p>8 Removable turntable
Place the turntable on the turntable support securely. The turntable will rotate clockwise or counterclockwise. Only remove for cleaning.</p> <p>9 Ventilation openings (Rear)</p> <p>10 Oven light
It will light when oven is operating or door is open.</p> <p>11 Waveguide cover: DO NOT REMOVE.</p> <p>12 Control panel</p> <p>13 Time display: 99 minutes, 99 seconds</p> <p>14 Rating plate</p> <p>15 Menu label</p> |
|---|---|

INTERACTIVE Display

The 7-digit Interactive Display spells out operating steps and shows cooking hints. When HELP is lighted in the display, press the **user pref** pad to read a specific hint which may assist you.

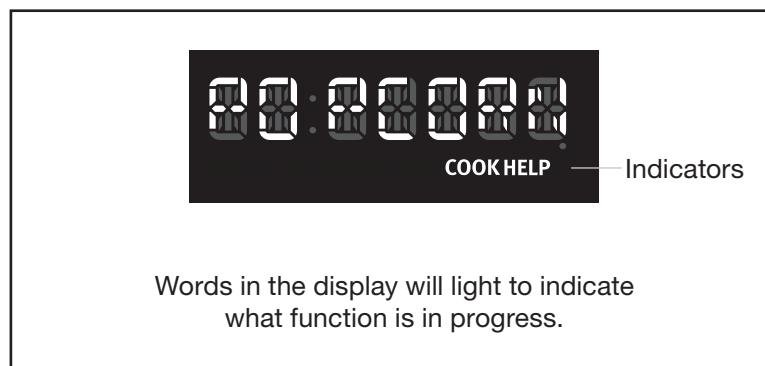

Words in the lower portion of the display will light to indicate what function is in progress.

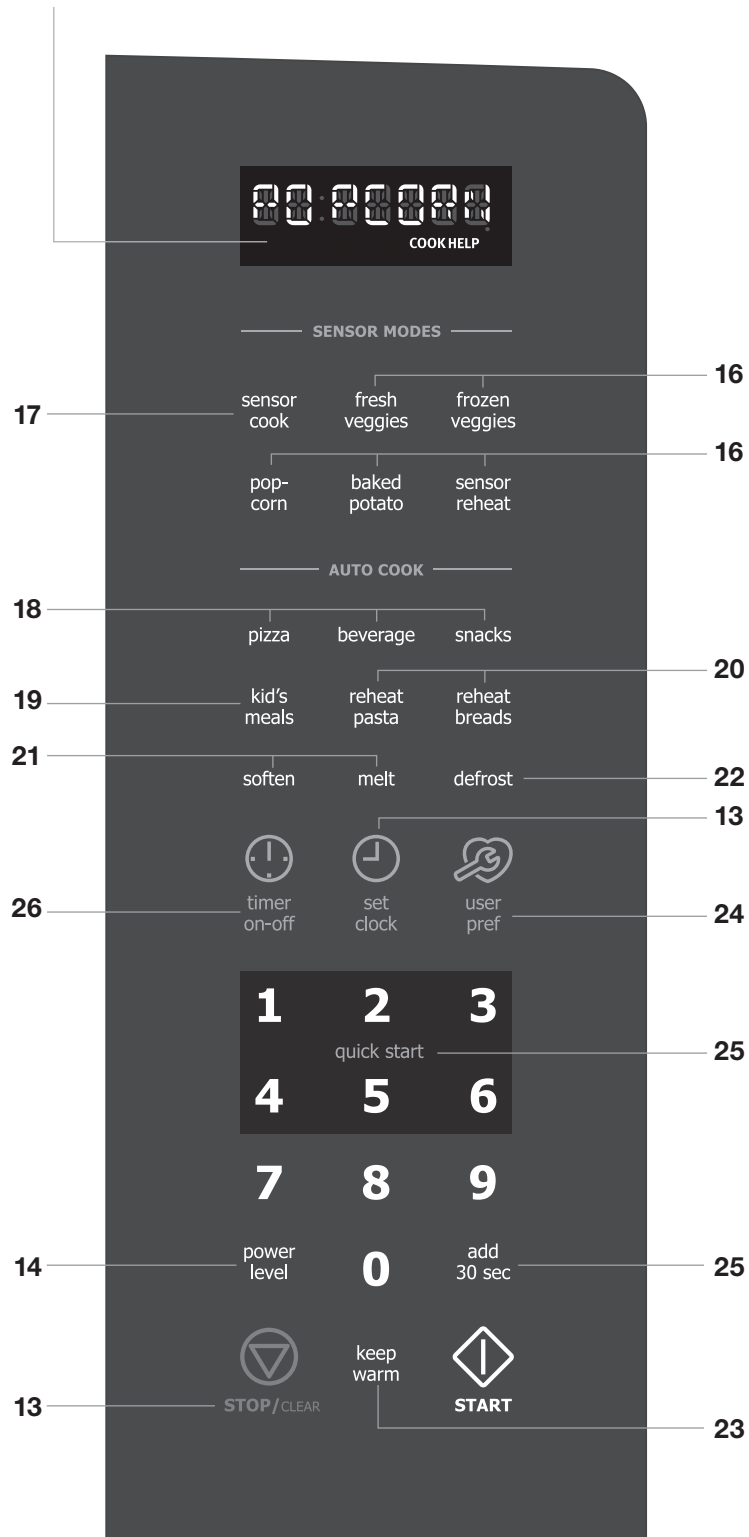

Number next to the control panel illustration indicates pages on which there are feature descriptions and usage information.



- Before operating your new Microwave Oven make sure you read and understand this Use and Care Guide completely.
- Before the Microwave Oven can be used, follow these procedures:
 1. Plug in the oven. Close the door. The oven display will show *ENJOY YOUR OVEN PRESS CLEAR AND PRESS CLOCK*.
 2. Press the **STOP/CLEAR** pad. : will appear.
 3. Set clock. See below.

This is a 12 hour clock. If you attempt to enter an incorrect clock time, *ERROR* will appear in the display. Press the **STOP/CLEAR** pad and re-enter the time.

- If the electrical power supply to your microwave oven should be interrupted, the display will intermittently show *ENJOY YOUR OVEN PRESS CLEAR AND PRESS CLOCK* after the power is reinstated. If this occurs during cooking, the program will be erased. The time of day will also be erased. Simply press **STOP/CLEAR** pad and reset the clock for the correct time of day.

To set the clock

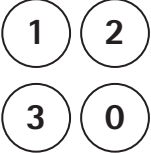
- Suppose you want to enter the correct time of day 12:30 (A.M. or P.M.).

Procedure	
Step	Press
1. Press set clock .	
2. Enter the correct time of day by pressing the numbers in sequence.	
3. Press set clock again.	

NOTE

Your Microwave Oven can be programmed with the door open except for **START** and **popcorn**.

Stop/Clear



Press the **STOP/CLEAR** to:

1. Erase if you make a mistake during programming.
2. Cancel timer.
3. Stop the oven temporarily during cooking.
4. Return the time of day to the display.
5. Cancel a program during cooking, press twice.

Time cooking

Your Microwave Oven can be programmed for 99 minutes 99 seconds (99.99). Always enter the seconds after the minutes, even if they are both zeros.

- Suppose you want to cook for 5 minutes at 100%.

Procedure	
Step	Press
1. Enter cooking time.	
2. Press START .	



To set power level

There are eleven preset power levels.

Using lower power levels increases the cooking time which is recommended for foods such as cheese, milk and long slow cooking of meats. Consult cook-book or recipes for specific recommendations.

Press power level pad number of times for desired power	Approx. Percentage of power	Common words for power levels
power level x 1	100%	High
power level x 2	90%	
power level x 3	80%	
power level x 4	70%	Medium High
power level x 5	60%	
power level x 6	50%	Medium
power level x 7	40%	
power level x 8	30%	Med Low/ Defrost
power level x 9	20%	
power level x 10	10%	Low
power level x 11	0%	

- Suppose you want to defrost for 5 minutes at 30%.

Procedure	
Step	Press
1. Enter defrosting time.	
2. Press power level pad eight times or hold down until the desired power level appears.	
3. Press START .	

When the defrost time is complete, a long tone will sound and *END* will appear in the display.

Manual defrost

If the food that you wish to defrost is not listed on the Defrost chart or is above or below the limits in the Amount column on the Defrost chart (see page 22), you need to defrost manually.

You can defrost any frozen food, either raw or previously cooked, by using Power Level for 30%. Follow the exact 3-step procedure found under To set power level. Estimate defrosting time and press **power level** pad eight times for 30% power.

For either raw or previously cooked frozen food the rule of thumb is approximately 4 minutes per pound. For example, defrost 4 minutes for 1 pound of frozen spaghetti sauce.

Always stop the oven periodically to remove or separate the portions that are defrosted. If food is not defrosted at the end of the estimated defrosting time, program the oven in 1 minute increments on power level 30% until totally defrosted.

When using plastic containers from the freezer, defrost only long enough to remove from the plastic in order to place in a microwave-safe dish.

The sensor is a semi-conductor device that detects the vapor (moisture and humidity) emitted from the food as it heats. The sensor adjusts the cooking times and power level for various foods and quantities.

Using Sensor Modes:

1. After oven is plugged in, wait 2 minutes before using Sensor Modes.
2. Be sure the exterior of the cooking container and the interior of the oven are dry. Wipe off any moisture with a dry cloth or paper towel.
3. The oven works with foods at normal storage temperature. For example, popcorn would be at room temperature.
4. Any Sensor Modes selection can be programmed with More or less time adjustment. See page 25.
5. More or less food than the quantity listed in the chart should be cooked following the guidelines in any microwave cookbook.
6. During the first part of any sensor cooking or reheating, food name will appear on the display. Do not open the oven door or press **STOP/CLEAR** during this part of the cycle. The measurement of vapor will be interrupted. If this occurs, an error message will appear. To continue cooking, press the **STOP/CLEAR** pad and cook manually.

When the sensor detects the vapor emitted from the food, remainder of cooking time will appear. Door may be opened when remaining cooking time appears on the display. At this time, you may stir or season food, as desired.
7. If the sensor does not detect vapor properly when popping popcorn, the oven will turn off, and the correct time of day will be displayed. If the sensor does not detect vapor properly when cooking other foods, **ERROR** will be displayed. Follow the instructions.
8. Check food for temperature after cooking. If additional time is needed, continue to cook manually.
9. Each food has a cooking hint. Press **user pref** pad when the **HELP** indicator is lighted in the display.

Covering Foods:

Some foods cook better when covered. Use the cover recommended in the food charts.

1. Casserole lid.
2. Plastic wrap: Use plastic wrap recommended for microwave cooking. Cover dish loosely; allow approximately 1/2 inch to remain uncovered to allow steam to escape. Plastic wrap should not touch food.
3. Wax paper: Cover dish completely; fold excess wrap under dish to secure. If dish is wider than paper, overlap two pieces at least one inch to cover.

Be careful when removing any covering to allow steam to escape away from you.

Quick Sensor

You can cook or reheat many foods by pressing a Quick Sensor pad (**fresh veggies, frozen veggies, popcorn, baked potato** and **sensor reheat**) and **START**. You don't need to calculate cooking time or power level.

- Suppose you want to cook 2 baked potatoes.

Procedure	
Step	Press

Press **baked potato** pad.

**baked
potato**

NOTES

1. Quick Sensor can be programmed with More or less time adjustment. See page 25.
2. The final result will vary according to the food condition (e.g. initial temperature, shape, quality). Check food for temperature after heating. If additional time is needed, continue to heat manually.



Quick Sensor chart

Food	Amount	Procedure
Fresh Veggies:		Wash and place in casserole. Add no water if vegetables have just been washed. Cover with lid for tender vegetables. Use plastic wrap for tender-crisp vegetables. Press fresh veggies pad once. After cooking, stir, if possible. Let stand, covered, for 2 to 5 minutes.
Soft		
Broccoli	0.25 - 2.0 lb	
Brussels sprouts	0.25 - 2.0 lb	
Cabbage	0.25 - 2.0 lb	
Cauliflower (flowerets)	0.25 - 2.0 lb	
Cauliflower (whole)	1 medium	
Spinach	0.25 - 1.0 lb	
Zucchini	0.25 - 2.0 lb	
Baked apples	2 - 4 medium	
Hard		
Carrots, sliced	0.25 - 2.0 lb	
Corn on cob	2 - 4 pcs.	
Green beans	0.25 - 2.0 lb	
Winter squash		
- diced	0.25 - 2.0 lb	
- halves	1 - 2	
Frozen Veggies	0.25 - 1.25 lb	Add no water. Cover with lid or plastic wrap. After cooking, stir and let stand, covered, for 3 minutes.
Popcorn	1 package 1.5 - 3.5 oz bag	Use only popcorn packaged for the microwave. Try several brands to decide which you like. Do not try to pop unpopped kernels.
Baked Potato	1 - 8 med.	Pierce with fork in several places. Place on paper towel on turntable. After cooking, remove from oven and let stand wrapped in foil for 5 to 10 minutes.
Sensor Reheat	4 - 36 oz	Place in dish or casserole slightly larger than amount to be reheated. Flatten, if possible. Cover with lid, plastic wrap or wax paper. Use covers such as plastic wrap or lids with larger quantities of more dense foods such as stews. After reheating, stir well, if possible. Re-cover and allow to stand 2 to 3 minutes. Foods should be very hot. If not, continue to heat with variable power and time.

Sensor Cook

You can cook many foods by pressing the **sensor cook** pad and the food number. You don't need to calculate cooking time or power level.

- Suppose you want to cook ground meat.

Procedure	
Step	Press
1. Press sensor cook pad, number 1 for ground meat.	 
2. Press START pad.	

NOTES

1. Sensor Cook can be programmed with More or less time adjustment. See page 25.
2. The final result will vary according to the food condition (e.g. initial temperature, shape, quality). Check food for temperature after heating. If additional time is needed, continue to heat manually.
3. Stay near the oven while it's in use and check cooking progress frequently so that there is no chance of overcooking food.

Sensor Cook chart

Food	Amount	Procedure															
1. Ground Meat	0.25 - 2.0 lb	Use this setting to cook ground beef or turkey as patties or in a casserole to be added to other ingredients. Place patties on a microwave-safe rack and cover with wax paper. Place ground meat in a casserole and cover with wax paper or plastic wrap. When oven stops, turn patties over or stir meat in casserole to break up large pieces. Re-cover and press START . After cooking, let stand, covered, for 2 to 3 minutes.															
2. Rice	0.5 - 2.0 cups	Place rice into a deep casserole dish and add double quantity of water. Cover with lid or plastic wrap. After cooking, stir, cover and let stand 3 to 5 minutes or until all liquid has been absorbed. <table border="1" data-bbox="602 1304 1317 1472"> <thead> <tr> <th>Rice</th> <th>Water</th> <th>Size of casserole dish</th> </tr> </thead> <tbody> <tr> <td>.5 cup</td> <td>1 cup</td> <td>1.5 quart</td> </tr> <tr> <td>1 cup</td> <td>2 cups</td> <td>2 quart</td> </tr> <tr> <td>1.5 cups</td> <td>3 cups</td> <td>2.5 or 3 quart</td> </tr> <tr> <td>2 cups</td> <td>4 cups</td> <td>3 quart or larger</td> </tr> </tbody> </table>	Rice	Water	Size of casserole dish	.5 cup	1 cup	1.5 quart	1 cup	2 cups	2 quart	1.5 cups	3 cups	2.5 or 3 quart	2 cups	4 cups	3 quart or larger
Rice	Water	Size of casserole dish															
.5 cup	1 cup	1.5 quart															
1 cup	2 cups	2 quart															
1.5 cups	3 cups	2.5 or 3 quart															
2 cups	4 cups	3 quart or larger															
3. Fish/Seafood	0.25 - 2.0 lb	Arrange in ring around shallow glass dish (roll fillet with edges underneath). Cover with plastic wrap. After cooking, let stand, covered, 3 minutes.															
4. Frozen Entrees	6 - 17 oz	Use this pad for frozen, convenience foods. It will give satisfactory results for most brands. You may wish to try several and choose your favorite. Remove package from outer wrapping and follow package directions for covering. After cooking, let stand, covered for 1 to 3 minutes.															
5. Chicken Breast	0.5 - 2.0 lb	Cover with vented plastic wrap. When oven stops, turn over. Shield with small, flat pieces of aluminum foil any areas that are cooking too rapidly. Re-cover and press START . After cooking, let stand, covered 3 to 5 minutes. Chicken should be 160°F.															

Your oven has convenient pads to assist with meal preparation. The Auto Cook settings will automatically compute the correct cooking time and microwave power level for foods shown in the following charts.

- Suppose you want to heat 1 cup of water.

Procedure	
Step	Press
Press beverage pad 2 times.	beverage x 2

NOTES

1. All Auto Cook settings can be programmed with More or less time adjustment. Press the **power level** pad once or twice before pressing **START** pad. See page 25.
2. Each food has a cooking hint. Press **user pref** pad when the *HELP* indicator is lighted in the display.
3. Should you attempt to enter more or less than the allowed amount, an error message will appear in the display.
More or less than the quantity listed in the chart should be cooked following the guidelines in any microwave cookbook.
4. The final cooking result will vary according to the food condition (e.g. initial temperature, shape, quality). Check food for temperature after cooking. If additional time is needed, continue to cook manually.

Auto Cook chart

Food	Amount	Procedure
Pizza	1 - 6 slices (6 - 8 oz)	Use this setting to reheat refrigerated leftover pizza, 1 slice is approximately 1/8th of a 12-inch pizza or 1/12th of a 16-inch pizza. If possible, place on paper towel on a microwave-safe rack. Press pizza pad to select number of slices.
Beverage	0.5 - 2.0 cups	This setting is good for restoring a cool beverage to a better drinking temperature. Stir liquid briskly before and after heating to avoid "eruption". Press beverage pad once for a 0.5 cup increase per press.
Snacks		
1. Microwave Pizza	1 (6 - 8 oz)	Use for frozen microwave pizza. Remove from package and unwrap. Follow package directions for use of package and/or silver crisping disc. Press snacks pad and the number 1. Press START .
2. Hand-held Snacks	3 - 4 oz	Use for frozen French fries, cheese sticks, appetizers etc. Remove from outer package. Follow package directions for how to wrap or cover. Be careful when removing from the oven as snack may be very hot. Press snacks pad and the number 2. Press START .
3. Hand-held Snacks	5 - 6 oz	Use for frozen French fries, cheese sticks, appetizers etc. Remove from outer package. Follow package directions for how to wrap or cover. Be careful when removing from the oven as snack may be very hot. Press snacks pad and the number 3. Press START .

Auto Cook chart (cont.)

Food	Amount	Procedure
Kid's Meals		
1. Chicken Nuggets	0.3 - 1.0 lb	Place frozen chicken nuggets on a flat plate allowing space between each, cover foods with paper towel. Press kid's meal pad and the number 1. Enter weight and press START . After cooking, open door, rearrange, close door and press START . Let stand, covered, for 1 to 3 minutes.
2. Hot Dogs	1 - 6	Place hot dog in bun. Wrap each with paper towel or napkin. Press kid's meal and the number 2. Press number 2 to select quantity and press START .
3. Frozen Kid's Meal	6 - 8 oz	Use this pad for frozen, convenience foods. It will give satisfactory results for most brands. You may wish to try several and choose your favorite. Remove package from outer wrapping and follow package directions for covering. Press kid's meal and the number 3. Press START . After cooking, let stand, covered for 1 to 3 minutes.

Reheat Pasta / Reheat Breads

The reheat settings automatically computes the correct warming and heating time and microwave power level for foods shown in the chart below.

- Suppose you want to heat 2 fresh rolls or muffins.

Procedure	
Step	Press
1. Press reheat breads .	reheat breads
2. Select desired reheat breads settings. (Ex: touch number 1 for fresh rolls or muffins)	1
3. Repeat touching same number pad to increase quantity.	1 x 2
4. Press START pad.	START

NOTES





1. To reheat different foods or foods above or below the quantity allowed, use manual operation.
2. Reheat settings can be programmed with More or less time adjustment. See page 25.

Reheat Pasta / Reheat Breads chart

Food	Amount	Procedure
Reheat Pasta	1 - 6 cups	Use this pad to reheat refrigerated canned or homemade pasta with sauce. For room temperature pastas, use Less option. Pasta without sauce double the quantity per setting. For example, measure 2 cups of cooked noodles and program for 1 cup. Cover with lid or plastic wrap. Press reheat pasta to select number of cups. After cooking, let stand, covered, 2 to 3 minutes.
Reheat Breads		
1. Fresh Rolls/ Muffins	1 - 10	Use this pad to warm rolls, muffins, biscuits, bagels etc. Large items should be considered as 2 or 3 regular size. Arrange on plate; cover with paper towel. For refrigerated rolls or muffins, it may be necessary to double the entered amount to ensure the proper serving temperature. For example, enter quantity of 2 for 1 refrigerated muffin. Touch number 1 pad to increase quantity and press START .
2. Frozen Rolls/ Muffins	1 - 10	Use this pad to warm frozen rolls, muffins, biscuits, bagels, etc. Large items should be considered as 2 or 3 regular size. Arrange on plate, cover with paper towel. Touch number 2 pad to increase quantity and press START .

Quick Settings (**soften** and **melt**) automatically compute the correct heating time and microwave power level for softening and melting foods shown in the chart.

- Suppose you want to melt 1 square of chocolate.

Procedure	
Step	Press
1. Press melt pad once.	
2. Select desired food by pressing number pad. Ex: Press number 2 for chocolate.	
3. Repeat pressing same number pad to select quantity. Ex: Press number 2 two more times for 1 square.	
4. Press START pad.	

NOTES

1. To soften or melt other food or foods except the quantity listed in the Quick settings Chart, use manual operation.
2. Quick Settings can be programmed with More or less time adjustment. See page 25.







Quick settings chart

Food	Amount	Procedure
Soften		
1. Ice Cream	1 pint 1/2 gallon	DO NOT COVER. After pressing soften , press number 1 two times for 1 pint. After pressing soften , press number 1 three times for 1/2 gallon.
2. Cream Cheese	3 oz 8 oz	After pressing soften , press number 2 two times for 3 oz. After pressing soften , press number 2 three times for 8 oz.
Melt		
1. Butter	2 tbsp 1/2 cup	Use a Pyrex measuring cup. Cover with plastic wrap. After pressing melt , press number 1 two times for 2 tbsp. After pressing melt , press number 1 three times for 1/2 cup.
2. Chocolate	1 cup chips 1 square	After pressing melt , press number 2 two times for 1 cup chips. After pressing melt , press number 2 three times for 1 square.

Defrost

Defrost automatically defrosts all the foods found in the Defrost chart below.

- Suppose you want to defrost a 2.0 pound steak.

Procedure	
Step	Press
1. Press defrost pad and number 2 for steak.	 
2. Enter weight by pressing the number pads 2 and 0. Ex: 2.0 lb steak.	 
3. Press START pad. The oven will stop so the food can be checked.	
4. After the 1st stage, open the door. Turn steak over and shield any warm portions. Close the door. Press START pad.	
5. After the 2nd stage, open the door. Shield any warm portions. Close the door. Press START pad.	

After defrost cycle ends, let stand, covered.

NOTES

1. To defrost other food or foods above or below the weights allowed on the Defrost chart, use time and 30% power. See Manual defrost on page 14.
2. Defrost can be programmed with More or less time adjustment. Press the **power level** pad once or twice before pressing **START** pad.
3. Press **user pref** pad when the *HELP* indicator is lighted in the display for a helpful hint.
4. If you attempt to enter more or less than the amount as indicated in the chart below, an error message will appear in the display.
5. Check foods when oven signals. After final stage, small sections may still be icy. Let stand to continue thawing. Do not defrost until all ice crystals are thawed.
6. Shielding prevents cooking from occurring before the center of the food is defrosted. Use small smooth strips of aluminum foil to cover edges and thinner sections of the food.

Defrost chart



Food	Amount	Procedure
1. Ground Meat	0.5 - 3.0 lb	Remove any thawed pieces after each stage. Let stand, covered, for 5 to 10 minutes.
2. Steaks/Chops/ Fish	0.5 - 4.0 lb	After each stage, rearrange and if there are warm or thawed portions, shield with small flat pieces of aluminum foil. Remove any meat or fish that is almost defrosted. Let stand, covered, for 10 to 20 minutes.
3. Chicken Pieces	0.5 - 3.0 lb	After each stage, rearrange pieces or remove portions should they become warm or thawed. Let stand, covered, for 10 to 20 minutes.
4. Roast	2.0 - 4.0 lb	Start defrosting with fat side down. After each stage, turn roast over and shield the warm portions with aluminum foil. Let stand, covered, for 30 to 60 minutes.
5. Casserole	2 - 6 cups	After audible signal, stir if possible. At end, stir well and let stand, covered, for 5 to 10 minutes.
6. Soup	1 - 6 cups	After audible signal, stir if possible. At end, stir well and let stand, covered, for 5 to 10 minutes.

Keep warm

Keep warm allows you to keep food warm for 30 minutes.

Direct use

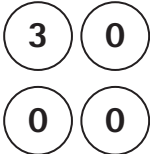
- Suppose you want to keep a cup of soup warm for 30 minutes.





Procedure	
Step	Press
1. Press keep warm pad.	
2. Enter the desired time.	
3. Press START pad.	

The oven will start. The display will show *30.00* and count down. *KEEP WARM* will be displayed during the countdown.

You can program Keep warm with manual cooking to keep food warm continuously after cooking.

With manual cooking

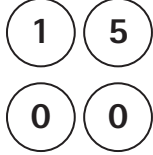
- Suppose you want to cook a cup of soup for 2 minutes at 70% and keep the soup warm for 15 minutes.

Procedure	
Step	Press
1. Enter cooking time.	
2. Press power level pad 4 times for 70% power.	
3. Press keep warm pad.	
4. Enter the desired time by pressing the number pads 1, 5, 0 and 0 for 15 minutes.	
5. Press START pad.	

The operation will start. When the cooking time is complete, a long tone will sound and Keep warm will start. *KEEP WARM* will appear in the display every 10 seconds and count down for 15 minutes.

NOTE

Keep warm cannot be programmed with Other Special Features.

User pref

User pref provides 4 features that make using your oven easy because specific instructions are provided in the interactive display.

1. CHILD LOCK

The Child Lock prevents unwanted oven operation such as by small children. The oven can be set so that the control panel is deactivated or locked. To set, press **user pref**, the number 1 and then press the **START** pad. Should a pad be touched, *CHILD LOCK ON* will appear in the display.

To cancel, press **user pref** and **STOP/CLEAR** pad.

2. AUDIBLE SIGNAL ELIMINATION







If you wish to have the oven operate with no audible signals, press **user pref**, the number 2 and **STOP/CLEAR**.







To cancel and restore the audible signal, press **user pref**, the number 2 and **START**.

3. AUTO START

If you wish to program your oven to begin cooking automatically at a designated time of day, follow this procedure:

- Suppose you want to start cooking a stew for 20 minutes on 50% at 4:30. Before setting, check to make sure the clock is showing the correct time of day.

Procedure	
Step	Press
1. Press user pref pad.	
2. Press number 3.	
3. Enter the start time.	  
4. Press set clock pad.	

Procedure	
Step	Press
5. Enter cooking time.	 
6. Press power level pad six times for 50% power.	   x 6
7. Press START pad.	

NOTES

1. Auto Start can be used for manual cooking if clock is set.
2. If the oven door is opened after programming Auto Start, it is necessary to press the **START** pad for Auto Start time to appear in the readout so that the oven will automatically begin programmed cooking at the chosen Auto Start time.
3. Be sure to choose foods that can be left in the oven safely until the Auto Start time. Acorn or butternut squash are often a good choice.

4. LANGUAGE SELECTION

The oven comes set for English and U.S. Customary Unit-pounds. To change, press **user pref** and the number 4. Continue to press the number 4 until your choice is selected from the table below. Then, press **START** pad.





Number	Language	Standard of weight
Once	English	LB
Twice	English	KG
3 times	Spanish	LB
4 times	Spanish	KG
5 times	French	LB
6 times	French	KG

Multiple sequence cooking

Your oven can be programmed for up to 4 automatic cooking sequences, switching from one power level setting to another automatically.

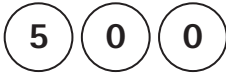
Sometimes cooking directions tell you to start on one power level and then change to a different power level. Your oven can do this automatically.

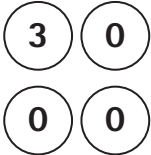
- Suppose you want to cook roast beef for 5 minutes at 100% and then continue to cook for 30 minutes at 50%.

Procedure	
Step	Press
1. Enter cooking time.	
2. Press power level pad once for 100% power.	 x 1
3. Enter second cooking time.	
4. Press power level pad 6 times for 50% power.	 x 6
5. Press START pad.	

NOTE

If 100% is selected as the final sequence, it is not necessary to press the **power level** pad.

More or less time adjustment

Should you discover that you like any of the Sensor Modes, Auto Cook, Quick Settings or Defrost slightly more done, press the **power level** pad once after pressing your choice of pads or before pressing **START** pad. The display will show *MORE*.

Should you discover that you like any of the Sensor Modes, Auto Cooks, Quick Settings or Defrost slightly less done, press the **power level** pad twice after pressing your choice of pads or before pressing **START** pad. The display will show *LESS*.

Quick Start

quick start is a short-cut method to set time for 1-6 minutes at power level 10.

- Suppose you want to heat a cup of soup for two minutes.

Procedure	
Step	Press
Press number 2 pad.	

The oven will start immediately and will signal then turn off automatically when finished.

Add 30 Seconds

add 30 seconds provides a convenient way to extend cooking time by 30 seconds while the oven timer is counting down. It will add 30 seconds to the time shown each time the pad is pressed.



This pad may also be used as a quick start for 30 seconds of cooking. No need to press **START**, the oven will start immediately.

Help

Each setting has a cooking hint. If you wish to check, press **user pref** whenever *HELP* is lighted in the Interactive Display for these and other manual operation hints.

Timer on-off

- Suppose you want to time a 3-minute long distance phone call.

Procedure	
Step	Press
1. Press timer on-off .	
2. Enter time.	
3. Press timer on-off . The timer will count down. To cancel the timer, press the STOP/CLEAR pad once.	

NOTE

timer on-off operates as a kitchen timer and cannot be used when the oven is operating.

Demonstration mode

To demonstrate, press **set clock**, the number 0 and then press the **START** pad and hold for three seconds. *DEMO ON* will appear in the display. Cooking operations and specific special features can now be demonstrated with no power in the oven. For example, press **add 30 seconds** pad and the display will show *.30* and count down quickly to *END*.

To cancel, press **set clock**, the number 0 and **STOP/CLEAR** pads. If easier, unplug the oven from the electrical outlet and replug.

Disconnect the power cord before cleaning or leave the door open to inactivate the oven during cleaning.

Exterior

Clean the outside with mild soap and water; rinse and dry with a soft cloth. Do not use any type of household or abrasive cleaner.

Door

Wipe the window on both sides with a damp cloth to remove any spills or splatters. Metal parts will be easier to maintain if wiped frequently with a damp cloth. Avoid the use of spray and other harsh cleaners as they may stain, streak or dull the door surface.

Stainless Steel Trim-Kit

Cleaners which are marked specifically for use with stainless steel may be used for stainless steel trim-kit. Follow package directions exactly. Avoid the use of any harsh cleaners or one not marked for stainless steel use as they may stain, streak or dull surface.

Touch Control Panel

Wipe the panel with a cloth dampened slightly with water only. Dry with a soft cloth. Do not scrub or use any sort of chemical cleaners. Close door and press **STOP/CLEAR**.

Interior

Cleaning is easy because little heat is generated to the interior surfaces; therefore, there is no baking and setting of spills or spattering. To clean the interior surfaces, wipe with a soft cloth and warm water. **DO NOT USE ABRASIVE OR HARSH CLEANERS OR SCOURING PADS.** For heavier soil, use baking soda or a mild soap; rinse thoroughly with hot water. The rack can be cleaned with hot soapy water, rinsed and dried.

Waveguide Cover

The waveguide cover is made from mica so requires special care. Keep the waveguide cover clean to assure good oven performance. Carefully wipe with a damp cloth any food splatters from the surface of the cover immediately after they occur. Built-up splashes may overheat and cause smoke or possibly catch fire. Do not remove the waveguide cover.

Odor Removal

Occasionally, a cooking odor may remain in the oven. To remove, combine 1 cup water, grated peel and juice of 1 lemon and several whole cloves in a 2-cup glass measuring cup. Boil for several minutes using 100% power. Allow to set in oven until cool. Wipe interior with a soft cloth.

Turntable/Turntable Support

The turntable and turntable support can be removed for easy cleaning. Wash them in mild, sudsy water; for stubborn stains use a mild cleanser and non abrasive scouring sponge. They are also dishwasher-proof. Use upper rack of dishwasher. The turntable motor shaft is not sealed, so excess water or spills should be wiped up immediately.

Please check the following before calling for service:

Place one cup of water in a glass measuring cup in the oven and close the door securely.

Operate the oven for one minute at HIGH 100%.

- A Does the oven light come on? YES ____ NO ____
- B Does the cooling fan work? YES ____ NO ____
(Put your hand over the rear ventilating openings.)
- C Is the water in the oven warm? YES ____ NO ____

If “NO” is the answer to any of the above questions, please check electrical outlet, fuse and/or circuit breaker. If they are functioning properly, CONTACT YOUR NEAREST ELECTROLUX AUTHORIZED SERVICER.

A microwave oven should never be serviced by a “do-it-yourself” repair person.

NOTE

If time appearing in the display is counting down very rapidly, check Demonstration Mode on page 26 and cancel.

EI24MO45I

AC Line Voltage:	UL & CSA Rating, Single phase 120V, 60Hz, AC only
AC Power Required:	UL & CSA Rating, 1500 watts, 13.0 amps.
Output Power:*	1100 watts
Frequency:	2450 MHz
Outside Dimensions:	24 5/8"(W) x 14 1/16"(H) x 19 5/16"(D)
Cavity Dimensions:**	17 3/8"(W) x 10 1/2"(H) x 18 5/8"(D)
Oven Capacity:	2.0 Cu. Ft.
Weight:	Approx. 44.5 lb

Trim Kit Dimensions

EI27MO45T	27"(W) x 18 1/16"(H) x 2 3/4"(D)
EI30MO45T	30"(W) x 18 1/16"(H) x 2 3/4"(D)

* The International Electrotechnical Commission's standardized method for measuring output wattage. This test method is widely recognized.

** Internal capacity is calculated by measuring maximum width, depth and height. Actual capacity for holding food is less.

In compliance with standards set by:

FCC - Federal Communications Commission Authorized.

DHHS - Complies with Department of Health and Human Services (DHHS) rule, CFR, Title 21, Chapter I, Subchapter J.



- This symbol on the nameplate means the product is listed by Underwriters Laboratories, Inc. for use in USA or Canada.

Major Appliance Warranty Information

Your appliance is covered by a one year limited warranty. For one year from your original date of purchase, Electrolux will repair or replace any parts of this appliance that prove to be defective in materials or workmanship when such appliance is installed, used, and maintained in accordance with the provided instructions. In addition, the magnetron tube of your appliance is covered by a two through five year limited warranty. During the 2nd through 5th years from your original date of purchase, Electrolux will provide a replacement magnetron tube for your appliance which has proven to be defective in materials or workmanship when your appliance is installed, used, and maintained in accordance with the provided instructions.

Exclusions

This warranty does not cover the following:

1. Products with original serial numbers that have been removed, altered or cannot be readily determined.
2. Product that has been transferred from its original owner to another party or removed outside the USA or Canada.
3. Rust on the interior or exterior of the unit.
4. Products purchased "as-is" are not covered by this warranty.
5. Food loss due to any refrigerator or freezer failures.
6. Products used in a commercial setting.
7. Service calls which do not involve malfunction or defects in materials or workmanship, or for appliances not in ordinary household use or used other than in accordance with the provided instructions.
8. Service calls to correct the installation of your appliance or to instruct you how to use your appliance.
9. Expenses for making the appliance accessible for servicing, such as removal of trim, cupboards, shelves, etc., which are not a part of the appliance when it is shipped from the factory.
10. Service calls to repair or replace appliance light bulbs, air filters, water filters, other consumables, or knobs, handles, or other cosmetic parts.
11. Labor or in-home service costs during the additional limited warranty periods beyond the first year from your original date of purchase.
12. Pickup and delivery costs; your appliance is designed to be repaired in the home.
13. Surcharges including, but not limited to, any after hour, weekend, or holiday service calls, tolls, ferry trip charges, or mileage expense for service calls to remote areas, including the state of Alaska.
14. Damages to the finish of appliance or home incurred during transportation or installation, including but not limited to floors, cabinets, walls, etc.
15. Damages caused by: services performed by unauthorized service companies; use of parts other than genuine Electrolux parts or parts obtained from persons other than authorized service companies; or external causes such as abuse, misuse, inadequate power supply, accidents, fires, or acts of God.

DISCLAIMER OF IMPLIED WARRANTIES; LIMITATION OF REMEDIES

CUSTOMER'S SOLE AND EXCLUSIVE REMEDY UNDER THIS LIMITED WARRANTY SHALL BE REPAIR OR REPLACEMENT AS PROVIDED HEREIN. **CLAIMS BASED ON IMPLIED WARRANTIES, INCLUDING WARRANTIES OF MERCHANTABILITY OR FITNESS FOR A PARTICULAR PURPOSE, ARE LIMITED TO ONE YEAR OR THE SHORTEST PERIOD ALLOWED BY LAW, BUT NOT LESS THAN ONE YEAR.** ELECTROLUX SHALL NOT BE LIABLE FOR CONSEQUENTIAL OR INCIDENTAL DAMAGES SUCH AS PROPERTY DAMAGE AND INCIDENTAL EXPENSES RESULTING FROM ANY BREACH OF THIS WRITTEN LIMITED WARRANTY OR ANY IMPLIED WARRANTY. SOME STATES AND PROVINCES DO NOT ALLOW THE EXCLUSION OR LIMITATION OF INCIDENTAL OR CONSEQUENTIAL DAMAGES, OR LIMITATIONS ON THE DURATION OF IMPLIED WARRANTIES, SO THESE LIMITATIONS OR EXCLUSIONS MAY NOT APPLY TO YOU. THIS WRITTEN WARRANTY GIVES YOU SPECIFIC LEGAL RIGHTS. YOU MAY ALSO HAVE OTHER RIGHTS THAT VARY FROM STATE TO STATE.

If You Need Service

Keep your receipt, delivery slip, or some other appropriate payment record to establish the warranty period should service be required. If service is performed, it is in your best interest to obtain and keep all receipts. Service under this warranty must be obtained by contacting Electrolux at the addresses or phone numbers below.

This warranty only applies in the USA, Puerto Rico and Canada. In the USA and Puerto Rico, your appliance is warranted by Electrolux Major Appliances North America, a division of Electrolux Home Products, Inc. In Canada, your appliance is warranted by Electrolux Canada Corp. Electrolux authorizes no person to change or add to any obligations under this warranty. Obligations for service and parts under this warranty must be performed by Electrolux or an authorized service company. Product features or specifications as described or illustrated are subject to change without notice.

USA

1-877-435-3287

Electrolux Major Appliances North America

P.O. Box 212378

Augusta, GA 30907

Canada

1-800-265-8352

Electrolux Canada Corp.

5855 Terry Fox Way

Mississauga, Ontario, Canada L5V 3E4