

# INSTALLATION INSTRUCTIONS

## CADET® 3

Flushing System

American Standard

Style That Works Better

### COMPACT CADET® 3 - 1.6 GPF ONE-PIECE TOILET

### COMPACT CADET® 3 FloWise™ - 1.28 GPF ONE-PIECE TOILET

### Model 2403 – Compact Elongated Right Height™ with Seat



Thank you for selecting American Standard – the benchmark of fine quality for over 100 years. To ensure this product is installed properly, please read these instructions carefully before you begin. (Certain installations may require professional help.) Also be sure your installation conforms to local codes.

**▲ CAUTION: PRODUCT IS FRAGILE. TO AVOID BREAKAGE AND POSSIBLE INJURY HANDLE WITH CARE!**  
 NOTE: Pictures may not exactly define contour of china and components.

#### RECOMMENDED TOOLS AND MATERIALS

Putty Knife	Regular Screwdriver	Adjustable Wrench	Sealant	Tape Measure
Hacksaw	Wax Ring/Gasket	Flexible Supply Tube	Closet Bolts	Carpenters Level

**1 REMOVE OLD TOILET**

- Close toilet supply valve and flush tank completely. Towel or sponge remaining water from tank and bowl.
- Disconnect and remove supply line. NOTE: *If replacing valve, first shut off main water supply!*
- Remove old mounting hardware, remove toilet and plug floor waste opening to prevent escaping sewer gases.
- Remove closet bolts from flange and clean away old wax, putty, etc. from base area.

NOTE: *Mounting surface must be clean and level before new toilet is installed!*

**2 ROUGHING-IN DIMENSIONS:**  
 NOTE: *Distance from wall to closet flange centerline must be as listed below:*

**3**

**INSTALL CLOSET BOLTS**  
 Install closet bolts in flange channel, turn 90°, and slide into place 6" (152 mm) apart and parallel to wall.

**4**

**INSTALL WAX SEAL**  
 Invert toilet on floor (cushion to prevent damage), and install wax ring evenly around waste flange (horn), with tapered end of ring facing toilet. Apply a thin bead of sealant around toilet base.

**5**

**POSITION TOILET ON FLANGE**

- Unplug floor waste opening and install toilet on closet flange so bolts project through mounting holes.
- Loosely install retainer washers and nuts. Side of washers marked "THIS SIDE UP" must face up!

SAVE FOR FUTURE USE

## 6 INSTALL TOILET

- a. Position toilet squarely to wall and, with a rocking motion, press bowl down fully on wax ring and flange.

Alternately tighten nuts until toilet is firmly seated on floor.

**CAUTION:** DO NOT OVERTIGHTEN NUTS OR BASE MAY BE DAMAGED!

- b. Install caps on washers. (If necessary, cut bolt height to size before installing caps.)
- c. Smooth off the bead of sealant around base. Remove excess sealant.

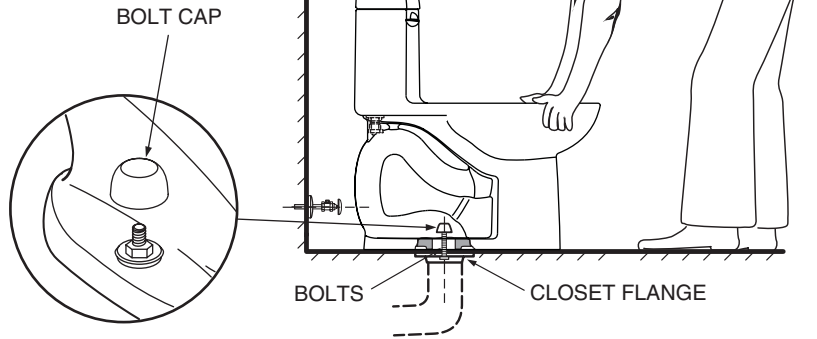

## 7 INSTALL TOILET SEAT

Install toilet seat in accordance with manufacturer's directions.

**8a** Before continuing, determine the type of water supply connection you have from the chart below and use the appropriate assembly parts required to properly reconnect the water supply. **DO NOT** use plumber's putty to seal these fittings.

### METAL/COPPER FLARED TUBING

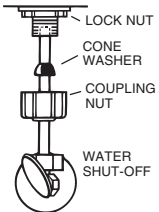

These parts must be used as illustrated to insure water-tight connection. Use of existing coupling nut may result in water leakage. Water supply tube or pipe must extend at least 1/2" inside threaded shank of valve (does not apply to flanged tubing).

### METAL FLANGED TUBING

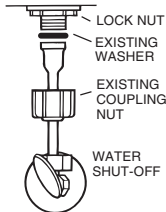

Use existing coupling nut and washer.

### METAL SPIRAL TUBING

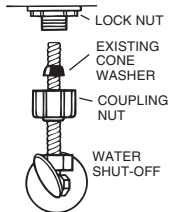

Use existing coupling cone washer. Fluidmaster cone washer may not seal completely on spiral type supply line.

### VINYL/BRAIDED CONNECTOR

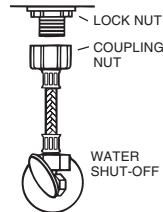

Captive cone washers already included. No additional washers needed.

**CAUTION: DO NOT USE CONE WASHER WITH PLASTIC SUPPLY LINE.**

**CAUTION: Overtightening of LOCK NUT or COUPLING NUT could result in breakage and potential flooding.**

## 8b

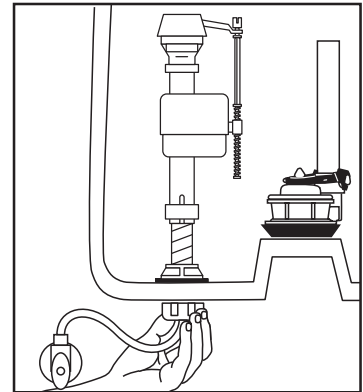

With correct washers in place (see Step 8a), tighten **COUPLING NUT** 1/4 turn beyond hand tight. **DO NOT OVERTIGHTEN.**



**WARNING:** Do not use plumber's putty, pipe dope, or any other sealant on the water supply connection to this tank. If the connection leaks after hand tightening, replace the supply line. If the connection continues to leak with the new supply line, replace the fill valve.

**Warranty is void if any type of sealant is used on the water supply connection.**

9

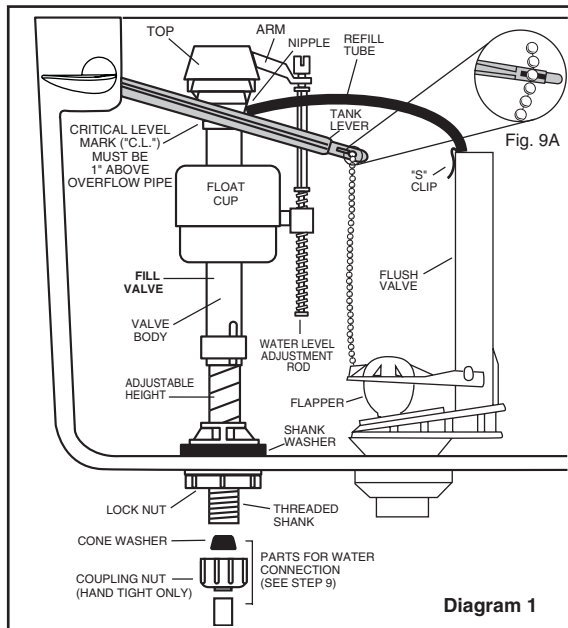

Diagram 1

## ADJUSTMENTS

- Adjust water level. Water level should be adjusted to level indicated on tank by adjusting float cup.

See Step 10 for water level adjustment method.

- If bowl fails to siphon, an adjustment may be required with the lift chain. Simply remove the bead chain from the retainment clip (see Fig. 9A) and take up slack on the chain, and reinsert on lift rod. Make sure the chain is not too taut.

10

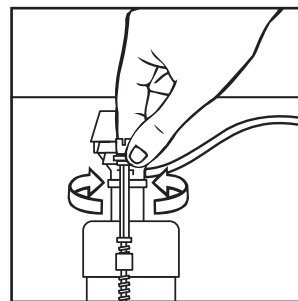

Turn on water supply. Submerge the FLOAT CUP under the water for 30 seconds. Adjust the water to desired level by turning WATER LEVEL ADJUSTMENT ROD and moving FLOAT CUP up or down.

11

## CARE AND CLEANING

When cleaning your toilet, wash it with mild, soapy water, rinse thoroughly with clear water and dry with a soft cloth. Avoid detergents, disinfectants, or cleaning products in aerosol cans. NEVER use abrasive scouring powders or abrasive pads on your toilet seat. Some bathroom chemicals and cosmetics may damage the seat's finish.



**WARNING:** Do not use in-tank cleaners. Products containing chlorine (calcium hypochlorite) can seriously damage fittings in the tank. This damage can cause leakage and property damage.

**American Standard shall not be responsible or liable for any tank fitting damage caused by the use of cleaners containing chlorine (calcium hypochlorite).**

12

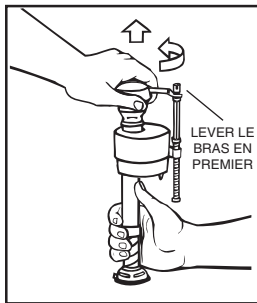

**IMPORTANT:** Always clear sand and rust from system.

- Make sure water supply is off. Remove valve TOP by lifting arm and rotating top and arm 1/8 turn counterclockwise, pressing down slightly on cap.

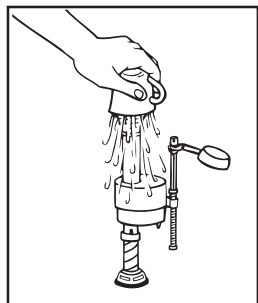

- While holding a container over the uncapped VALVE to prevent splashing, turn water supply on and off a few times. Leave water supply off.

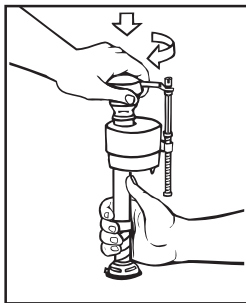

- Replace TOP by engaging lugs and rotating 1/8 turn clockwise. MAKE CERTAIN TIP IS TURNED TO THE LOCKED POSITION. VALVE MAY NOT TURN ON IF TOP IS NOT FULLY TURNED TO THE LOCKED POSITION.

## TROUBLESHOOTING

**IF FILL VALVE SHUTS OFF BUT CONTINUES TO LEAK SLOWLY,** repeat Step 12.

**IF FILL VALVE TURNS OFF AND ON DURING PERIODS OF NON-USE,** it is a signal you are wasting water because:

- The end of the refill tube is inserted into overflow pipe, below water level in tank. Attach refill tube to overflow pipe using "S" clip provided.
- The flush valve is leaking because it's worn, dirty or misaligned with tank ball or flapper (replace with a new flapper).

**IF FILL VALVE WON'T TURN ON OR SHUT OFF or REFILL OF TANK WATER IS SLOW** after valve has been in use for some time, Fluidmaster Model 242 Replacement Seal may be needed.

Go to our website at [www.fluidmaster.com](http://www.fluidmaster.com) for more solutions to toilet problems.

For troubleshooting information please contact:

**Fluidmaster** Inc

30800 Rancho Viejo Road  
San Juan Capistrano, CA 92675  
(949) 728-2000 (800) 631-2011  
[www.fluidmaster.com](http://www.fluidmaster.com)

Always use quality Fluidmaster repair parts when maintaining your Fluidmaster products. Fluidmaster shall not be responsible or liable for any damages caused by products used with Fluidmaster valves that were not manufactured by Fluidmaster, Inc.

**FLUIDMASTER WATER CONTROL**

**TANK COVER**

**FLUSH VALVE**

**FLAPPER ASSEMBLY**

**SEAT AND COVER (INCLUDES MTG. KIT)**

**SEAT POST MTG. KIT**

**TRIP LEVER**

**BOLT CAPS**

### COMPACT CADET® 3 ONE PIECE REPAIR PARTS LIST

*NOTE: "XXX" represents color options. Specify when ordering.*

COMPONENT	DESCRIPTION	1.6 GPF	1.28 GPF
735125.XXX0A	Tank Cover	√	√
5350.110.XXX	Seat - Elongated	√	√
034783-XXX0A	Bolt Cap Kit	√	√
738903-XXX0A	Trip Lever - Left Hand	-	-
738919-XXX0A	Trip Lever - Right Hand	-	-
738565-409.0070A	Inlet Valve	√	√
738942-1000A	Flush Valve - 1.6 GPF	√	
738920-0070A	Flapper Assembly - 1.6 GPF	√	
738942-1010A	Flush Valve - 1.28 GPF		√
7381043-400.0070A	Flapper Assembly - 1.28 GPF w/Float		√

TROUBLESHOOTING GUIDE		
PROBLEM	POSSIBLE CAUSE	CORRECTIVE ACTION
Does not flush	a. Water supply valve closed. b. Supply line blocked.  c. Flush valve chain too loose or disconnected. d. Sand or debris lodged in water control.	a. Open valve and allow water to fill tank. b. Shut off water supply, disconnect supply line, and inspect all gaskets and washers. Reassemble. Also, see Fluidmaster maintenance (see step 12). c. Readjust chain length as required. d. Shut off water supply. Remove cap and clean per Step 12.
Poor or sluggish flush	a. Bowl water level too low. b. Supply valve partly closed. c. Partially clogged trapway and/or drain pipe and/or vent. d. Supply pressure too low.	a. Check that refill tube is connected to water control and inserted into tank overflow without being kinked or damaged. b. Open supply valve fully. Be sure that proper supply tube size is used. c. Remove obstruction. Consult a plumber if necessary. d. Normal supply pressure must be at least 20 psi.
Toilet leaks	a. Poor supply line connection. b. Poor bowl to tank/floor connection.	a. Review Step 8 of installation procedure. b. Review Step 4 through 6 of installation procedure.
Toilet does not shut off	a. Flush valve chain too tight, holding flush valve open. b. Flush valve seat and/or flapper worn or deformed. c. Sand or debris lodged in water control.	a. Readjust chain length as needed. Review step 9. b. Replace flapper/flush valve assembly, as needed. c. Shut off water supply. Remove cap and clean per Step 12.

<p><b>In the United States:</b>          American Standard Brands          P.O. Box 6820          Piscataway, New Jersey 08855          Attention: Director of Consumer Affairs          For residents of the United States, warranty information may also be obtained by calling the following toll free number: (800) 442-1902  <a href="http://www.americanstandard-us.com">www.americanstandard-us.com</a></p>	<p><b>In Canada:</b>          AS Canada ULC          2480 Stanfield Rd.          Mississauga, Ontario          Canada L4Y 1S2          Toll Free: (800) 387-0369  <a href="http://www.americanstandard.ca">www.americanstandard.ca</a></p>	<p><b>In Mexico:</b>          Customer Service Manager          AS Maquila, S.A. de C.V.          Via Morelos #330          Col. Santa Clara          Ecatepec 55540 Edo. Mexico  <a href="http://www.americanstandard.com.mx">www.americanstandard.com.mx</a></p>
--	--	--