

PERFORMANCE DATA NO LOAD & NO DOOR OPENINGS AT MID-POINT CONTROL SETTING		
Type A With Run/Start Capacitor	65°F (18°C) Ambient	90°F (32°C) Ambient
Operating Time	25 to 35%	45 to 55%
Freezer Temperature	2° to 8°F (-17° to -13°C)	0° to 5°F (-18° to -15°C)
Refrigerator Temperature	35° to 40°F (2° to 4°C)	35° to 40°F (1° to 4°C)
Low Side Pressure (cut-in)	8 to 16 psig ( 55 to 110 kPa)	8 to 16 psig (55 to 110 kPa)
Low Side Pressure (cut-out)	1 to 4 psig (7 to 28 kPa)	1 to 4 psig (7 to 28 kPa)
High Side Pressure (last 1/3 cycle)	110 to 120 psig (758 to 827 kPa)	150 to 175 psig (1034 to 1207 kPa)
Wattage (last 1/3 cycle)	88 to 115	88 to 115
Amps (running)	0.8 to 1.1	0.8 to 1.1
Base Voltage	115 vac (127 vac max)	115 vac (127 vac max)
Refrigerant Charge	4.25 oz. (121 g)	

DEFROST SPECIFICATIONS					
Cabinet Size: 15'16'/18'/20'	Safety Thermostat		Heater		Defrost Thermistor
	Cut-in	Cut-out	Watts	Ohms	Termination
	110°F (43.3°C)	135°F (57.2°C)	375	35	47°F (8.3°C)

CONDENSER FAN MOTOR		
Watts	RPM	Amps
3.1	1100 CW Opposite Shaft	0.03 Running

EVAPORATOR FAN MOTOR		
Watts	RPM	Amps
6.2	2600 CW	0.05 Running

ICE MAKER SPECIFICATIONS		
Electrical	115 vac (127 vac max) 60 Hertz	
Thermostat	Ice maker with black housing	Opens at 52°F (11°C) Closes at 12°F (-11°C)
	Ice maker with white housing	Opens at 48°F (8.9°C) Closes at 9°F (-12.8°C)
Heater Wattage	165 W	

ICE MAKER CONNECTOR PLUG CONNECTIONS		
Wire Number	Wire Color	Connects to:
1	Green / Yellow	Ground
2	Yellow	Water Valve
3	Black	Line
4	Light Blue	Neutral

### ICE MAKER INFORMATION

**Test Cycling:** Remove cover by inserting screwdriver in notch at bottom and prying cover from housing. Use screwdriver to rotate motor gear counter-clockwise until holding switch circuit is completed. All components of ice maker should function to complete the cycle.

**Water Fill Volume:** The water fill adjustment screw will change the fill time. One full turn is equal to 20cc (.68 oz.). The correct fill is 102 to 130cc (3.4 to 4.3 oz.). When a water valve is replaced, the fill volume must be checked.

## SERVICE DATA SHEET

A01511103

### STANDARD - AUTOMATIC DEFROST TOP MOUNT FREEZER - R134a

#### IMPORTANT SAFETY NOTE

The information provided herein is designed to assist qualified repair personnel only. Untrained persons should not attempt to make repairs due to the possibility of electrical shock. Disconnect power cord before servicing this appliance.

#### IMPORTANT

If any green grounding wires are removed during servicing, they must be returned to their original position and properly secured.

#### CAUTION

All electrical parts and wiring must be shielded from torch flame. DO NOT allow torch to touch insulation; it will char at 200°F and flash ignite (burn) at 500°F. Excessive heat will distort the plastic liner.

DOOR AJAR ALARM	
Condition:	Fresh Food Door is left open for more than 5 minutes and alarm sounds.
Duration:	Alarm will sound for 2 minutes, then stop. If the "Door Ajar" condition remains, the alarm will repeat every 30 minutes for two intervals.
Fresh Food Light:	After 15 minutes of "Door Ajar" condition, the Fresh Food light will turn off.
Reset:	Close the Fresh Food door or Press the Fresh Food Door switch.

MANUAL DEFROST	
Unit will complete normal defrost cycle.	
enter	--> Press the FF door switch 5 times in 2 secs.; Alarm sounds 5 short beeps to acknowledge MANUAL DEFROST.
exit	--> Cycle power to the unit or enter and exit SERVICE MODE. (See SERVICE MODE)

Defrost is terminated when defrost thermistor located on the evaporator coil reaches 47°F. Safety Thermostat in the defrost circuit is a safety device only. It will interrupt power to the defrost heater at 135°F.

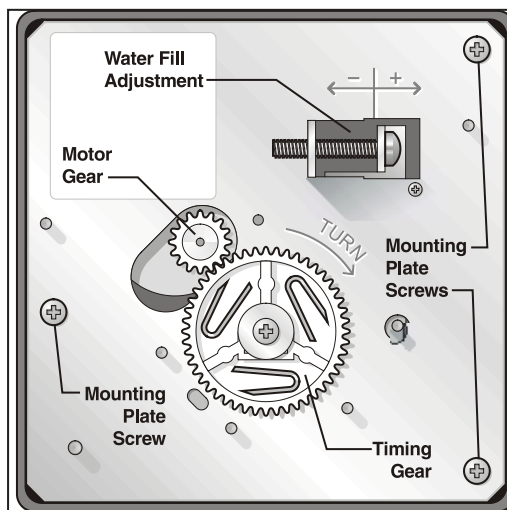

## IMPORTANT PLEASE RETURN THIS SHEET TO ITS ORIGINAL LOCATION.

SERVICE MODE	
SERVICE MODE will step through available tests to diagnose individual electrical circuits. Fresh Food compartment light will be OFF while in SERVICE MODE.	
enter/exit	--> Press the door switch 3 times and hold the 4th press until 1 long beep is heard. The door switch must be pressed 4 times in 2 seconds.
initiate first/next test	--> Press the door switch 2 times; 2 short beeps acknowledge selection.
1	Compressor
2	Heater
3	FF Light
4	Evaporator Fan

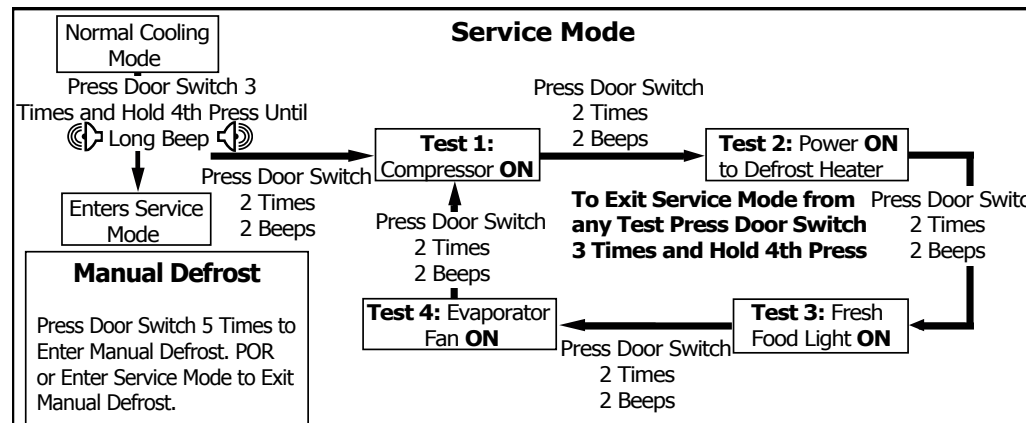

**IMPORTANT**  
**START-UP NOTE:** Upon 1st start-up or power cycle, the compressor will come on after 12 seconds and run for 115 seconds. If the door switch is not cycled during this time, the compressor will cut off after 115 seconds and not turn back on for another 5 minutes. It may take up to 10 minutes for the compressor to turn on and run in normal mode.

TEMPERATURE/RESISTANCE CHART FOR FRESH FOOD THERMISTOR AND DEFROST THERMISTOR							
°F	KOHMS	°F	KOHMS	°F	KOHMS	°F	KOHMS
-10	83.88	11	47.25	32	27.20	53	16.87
-9	81.56	12	46.02	33	27.04	54	16.49
-8	79.32	13	44.84	34	26.38	55	16.13
-7	77.15	14	43.67	35	25.75	56	16.77
-6	75.04	15	42.55	36	25.13	57	15.41
-5	73.02	16	41.45	37	24.53	58	15.07
-4	71.02	17	40.39	38	23.95	59	14.74
-3	69.08	18	39.36	39	23.38	60	14.42
-2	67.16	19	38.36	40	22.83	61	14.10
-1	65.34	20	37.39	41	22.29	62	13.79
0	63.55	21	36.44	42	21.77	63	13.49
1	61.82	22	35.53	43	21.26	64	13.21
2	60.15	23	34.63	44	20.77	65	12.92
3	58.20	24	33.78	45	20.29	66	12.65
4	56.97	25	32.94	46	19.83	67	12.38
5	55.43	26	32.13	47	19.37	68	12.11
6	53.97	27	31.33	48	18.92	69	11.85
7	52.53	28	30.57	49	18.49	70	11.60
8	51.16	29	29.83	50	18.07	71	11.36
9	49.81	30	29.10	51	17.66	72	11.12
10	48.51	31	28.39	52	17.26	73	10.88

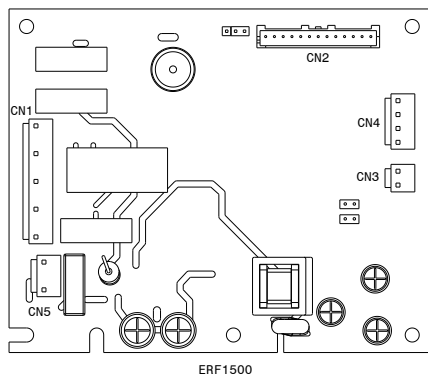
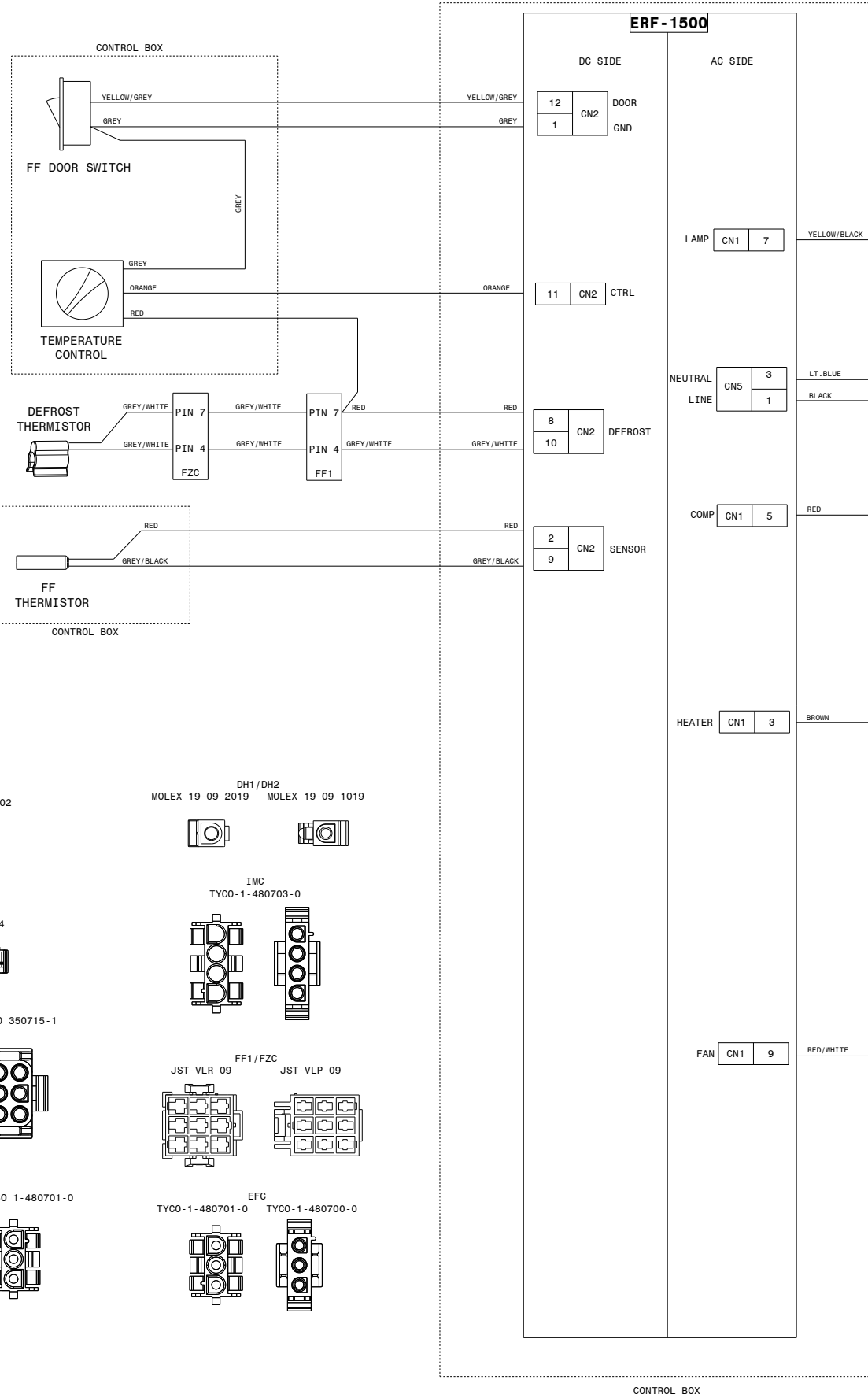
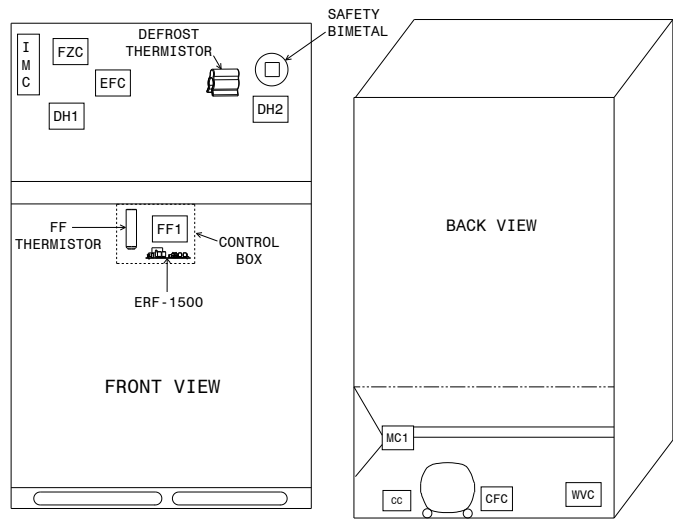

CC  
MOLEX-43335-2002



DH1 / DH2  
MOLEX 19-09-2019 MOLEX 19-09-1019



WVC  
TYCO-520935-4



MC1  
TYCO 1-480705-0 TYCO 350715-1

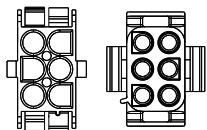

IMC  
TYCO-1-480703-0

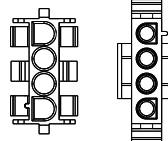

FF1 / FZC  
JST-VLR-09 JST-VLP-09

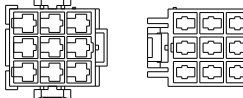

CFC  
TYCO 1-480700-0 TYCO 1-480701-0

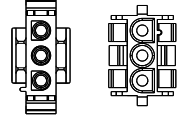

EFC  
TYCO-1-480701-0 TYCO-1-480700-0

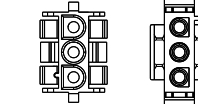

INLINE CONNECTOR ABBREVIATION KEY	
ABBREVIATION	EXPLANATION
MC1	6 PIN CONNECTION LEFT OF COMPRESSOR IN MACHINE COMPARTMENT
FF1	9 PIN CONNECTION IN CONTROL BOX
CC	2 PIN CONNECTION TO COMPRESSOR
CFC	3 PIN CONNECTION TO CONDENSER FAN
WVC	2 PIN CONNECTION TO ICE MAKER WATER VALVE (GREEN)
IMC	ICE MAKER CONNECTION IN FREEZER
FZC	9 PIN CONNECTION IN FREEZER
EFC	EVAPORATOR FAN CONNECTION IN FREEZER
DH1	DEFROST HEATER CONNECTION IN FRZ LEFT OF EVAP FAN
DH2	DEFROST HEATER CONNECTION IN FRZ RIGHT OF EVAP FAN

