



Back Vent Applications (Page 1 of 4)

Hood Model/Hood Style	Back Vent Diagram	K250 (3-1/4" x 10")	B100 (6" Round)	B200 (8" Round)	B300 (8" Round & 6" Round)	B400 (Two 8" Round)
K-Series Under Cabinet Hood and Liner Insert	A	Standard	n/a	n/a	n/a	n/a
6" Under Cabinet (Excluding K-Series)	B	n/a	VP513	VP515 or VP561	VP513 & VP515 or VP561	2-VP515 or 2-VP561
9" Under Cabinet	B	n/a	VP513	VP515 or VP561	VP513 & VP515 or VP561	2-VP515 or 2-VP561
CWEH6-K	B	VP559	n/a	n/a	n/a	n/a
CWEH9	B	n/a	VP513	VP515 or VP561	VP513 & VP515 or VP561	2-VP515 or 2-VP561
CWLH9	B	n/a	VP513	VP515 or VP561	VP513 & VP515 or VP561	2-VP515 or 2-VP561
GTH-K	D	VP559	n/a	n/a	n/a	n/a
XLH12 with 10" x 10" Duct Cover	D	n/a	n/a	VP515 or VP561	n/a	n/a
ZTH	D	n/a	n/a	VP515 or VP561	VP513 & VP515 or VP561	n/a
18" Tall Wall Mount	B	n/a	VP513	VP515 or VP561	VP513 & VP515 or VP561	2-VP515 or 2-VP561
18" Tall Wall Mount - Special Deck at 9"	C	n/a	VP513	VP561*	VP513 & VP561*	2-VP561*
14" Tall Eurostyle Wall Mount (PD, SLD)	D	n/a	VP513	n/a	n/a	n/a
18" Tall Eurostyle Wall Mount (EP, NEP, SEP)	D	n/a	n/a	VP561*	n/a	n/a
18" Tall Eurostyle Wall Mount (EPT, NEPT, SEPT)	C	n/a	n/a	n/a	VP513 & VP515 or VP561	n/a
30" Tall Wall Mount	C	n/a	VP513	VP515 or VP561	VP513 & VP515 or VP561	2-VP515 or 2-VP561
CWH	B	n/a	VP513	VP515 or VP561	VP513 & VP515 or VP561	2-VP515 or 2-VP561
TILT-Out (TLH)	C	n/a	VP513	VP561*	n/a	n/a
JCH/A1 Designer Series	D	n/a	VP513	VP515 or VP561	VP513 & VP515 or VP561	2-VP515 or 2-VP561
JCH/B1 Designer Series	D	n/a	VP513	VP515 or VP561	VP513 & VP515 or VP561	2-VP515 or 2-VP561
JCH/C1 Designer Series	C	n/a	VP513	VP515 or VP561	VP513 & VP515 or VP561	2-VP515 or 2-VP561
JCH/C2 Designer Series	C	n/a	VP513	VP515 or VP561	VP513 & VP515 or VP561	2-VP515 or 2-VP561
JDH/C1 Designer Series	C	n/a	VP513	VP515 or VP561	VP513 & VP515 or VP561	2-VP515 or 2-VP561
JDH/C2 Designer Series	C	n/a	VP513	VP515 or VP561	VP513 & VP515 or VP561	2-VP515 or 2-VP561
JDH/D1 Designer Series	C	n/a	VP513	VP515 or VP561	VP513 & VP515 or VP561	2-VP515 or 2-VP561
12" Tall Magic Lung Wall Mount Liner Insert	B	n/a	VP513	VP515 or VP561	VP513 & VP515 or VP561	2-VP515 or 2-VP561

**Can also use VP515(s) with duct cover (elbow(s) will extend above the top of the hood.*

Note: This chart outlines the most common applications. Contact Vent-A-Hood or your distributor for more information.

SPECIFICATIONS SUBJECT TO CHANGE WITHOUT NOTICE (Rev. 04/11a)

Elbow and Transition Heights

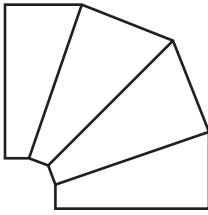

VP513: 6" Round - 8 1/2" Tall
When Fully Adjusted to 90 Degrees

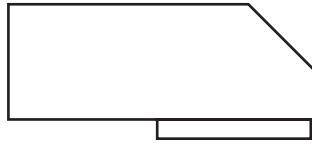

VP561: 8" Round to 6" x 8 1/2"
Rectangular - 7" Tall

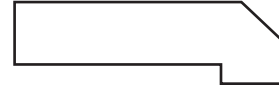

VP559: 3 1/4" x 10" - 4 1/4" Tall

VP515: 8" Round - 10 3/4" Tall
When Fully Adjusted to 90 Degrees

Diagram A - Direct Back Vent (Drawing Not To Scale)

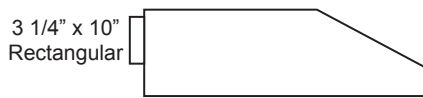

3 1/4" x 10"
Rectangular

Side View

Diagram B - Off the Top (Drawing Not To Scale)

VP513 - 6" Round VP561 - 8" Round
VP515 - 8" Round to 6" x 8 1/2" Rectangular

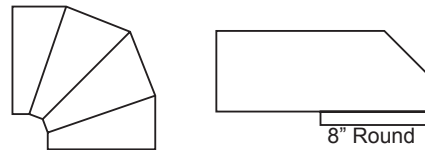

8" Round

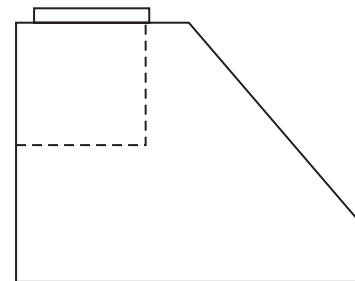

Side View

Diagram C - Within the Height of the Hood (Drawing Not To Scale)

VP513 - 6" Round VP561 - 8" Round
VP515 - 8" Round to 6" x 8 1/2" Rectangular

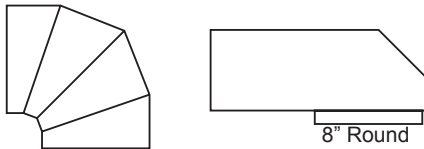

8" Round

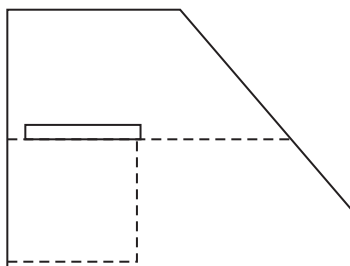

Side View

Diagram D - Off the Top Within the Duct Cover (Drawing Not To Scale)

VP513 - 6" Round VP561 - 8" Round
VP515 - 8" Round to 6" x 8 1/2" Rectangular

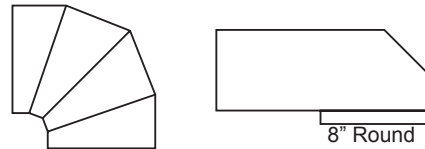

8" Round

VP559 - 3 1/4" x 10"
Rectangular

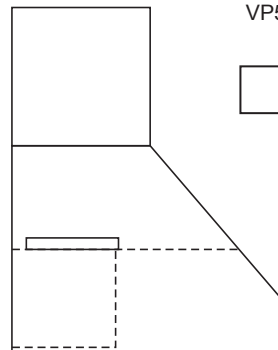

Side View

Back Vent Applications (Page 2 of 4)

NOTE: Excluding the SLH6-K, Under Cabinet Range Hood and the KHSLD Liner Insert, all Vent-A-Hood range hoods duct out the top and can be back-vented only by use of transitions and/or elbows.

Transition Heights

VP559: 3 1/4" x 10" Rectangular - 4 1/4" Tall

VP513: 6" Round - 8 1/2" Tall When Adjusted To 90 Degrees

VP515: 8" Round - 10 3/4" Tall When Adjusted To 90 Degrees

VP561: 8" Round To 6" x 8 1/2" Rectangular - 7" Tall

VP559 - 3 1/4" x 10"
Rectangular

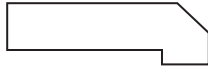

VP513 - 6" Round
VP515 - 8" Round

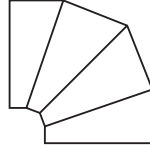

VP561 - 8" Round
to 6" x 8 1/2" Rectangular

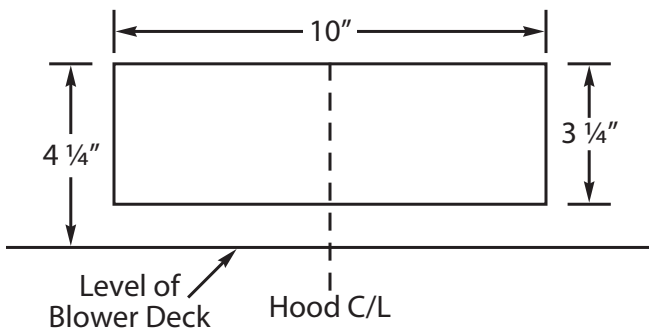

**K Series With VP559
Installed (Back View)**

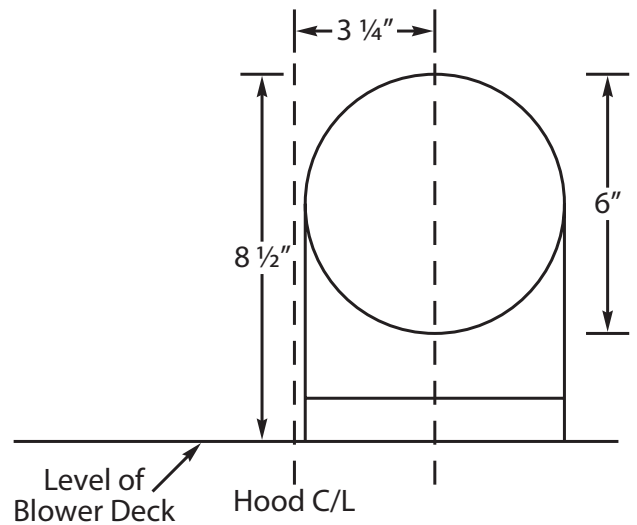

**B100 Blower Outlet With VP513
Installed (Back View)**

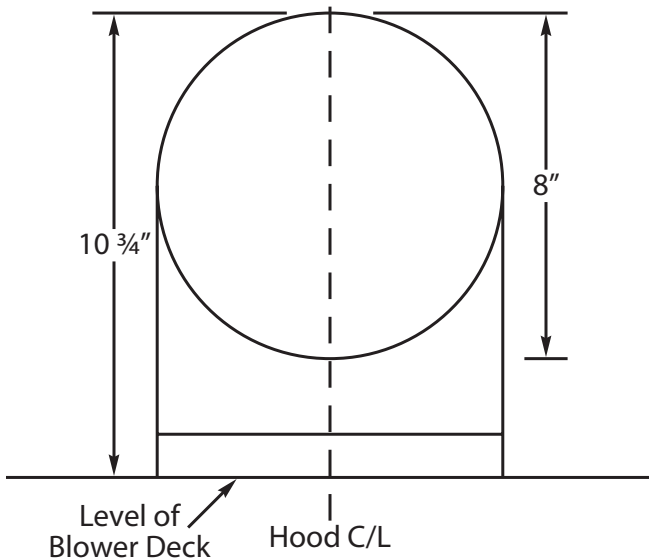

**B200 Blower Outlet With VP515
Installed (Back View)**

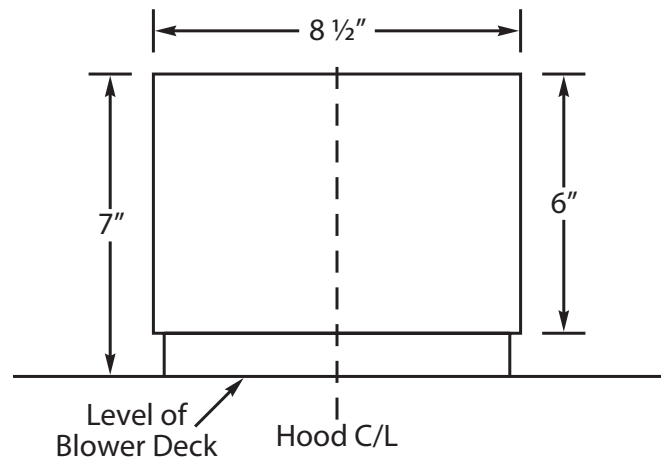

**B200 Blower Outlet With VP561
Installed (Back View)**

Back Vent Applications (Page 3 of 4)

NOTE: Excluding the SLH6-K, Under Cabinet Range Hood and the KHSLD Liner Insert, all Vent-A-Hood range hoods duct out the top and can be back-vented only by use of transitions and/or elbows.

Transition Heights

VP513: 6" Round - 8 1/2" Tall When Adjusted To 90 Degrees

VP515: 8" Round - 10 3/4" Tall When Adjusted To 90 Degrees

VP561: 8" Round To 6" x 8 1/2" Rectangular - 7" Tall

VP513 - 6" Round
VP515 - 8" Round

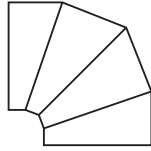

VP561 - 8" Round
to 6" x 8 1/2" Rectangular

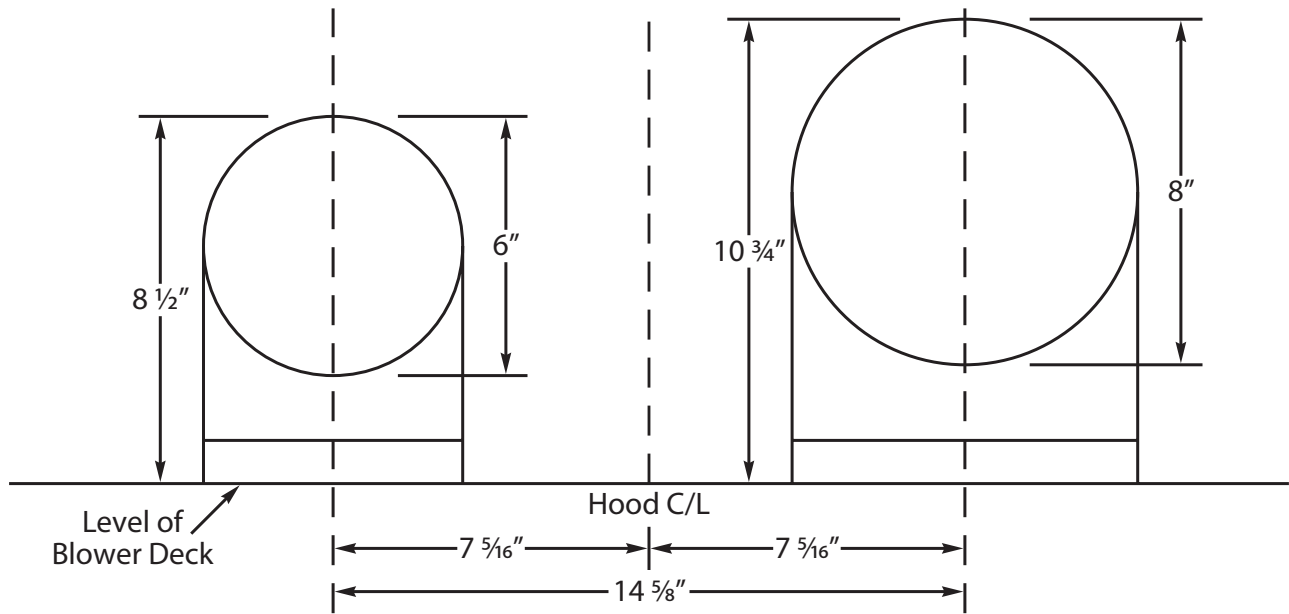

**B300 Blower Outlets With VP513
And VP515 Installed (Back View)**

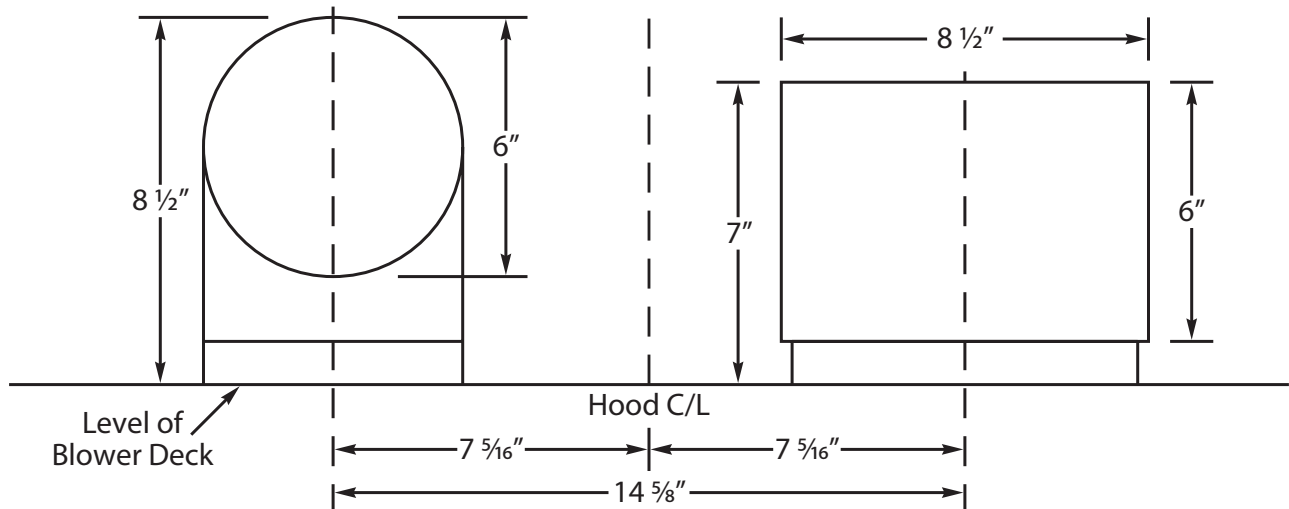

**B300 Blower Outlets With VP513
And VP561 Installed (Back View)**

Back Vent Applications (Page 4 of 4)

NOTE: Excluding the SLH6-K, Under Cabinet Range Hood and the KHSLD Liner Insert, all Vent-A-Hood range hoods duct out the top and can be back-vented only by use of transitions and/or elbows.

Transition Heights

VP513: 6" Round - 8 1/2" Tall When Adjusted To 90 Degrees

VP515: 8" Round - 10 3/4" Tall When Adjusted To 90 Degrees

VP561: 8" Round To 6" x 8 1/2" Rectangular - 7" Tall

VP513 - 6" Round
VP515 - 8" Round

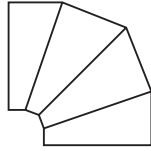

VP561 - 8" Round
to 6" x 8 1/2" Rectangular

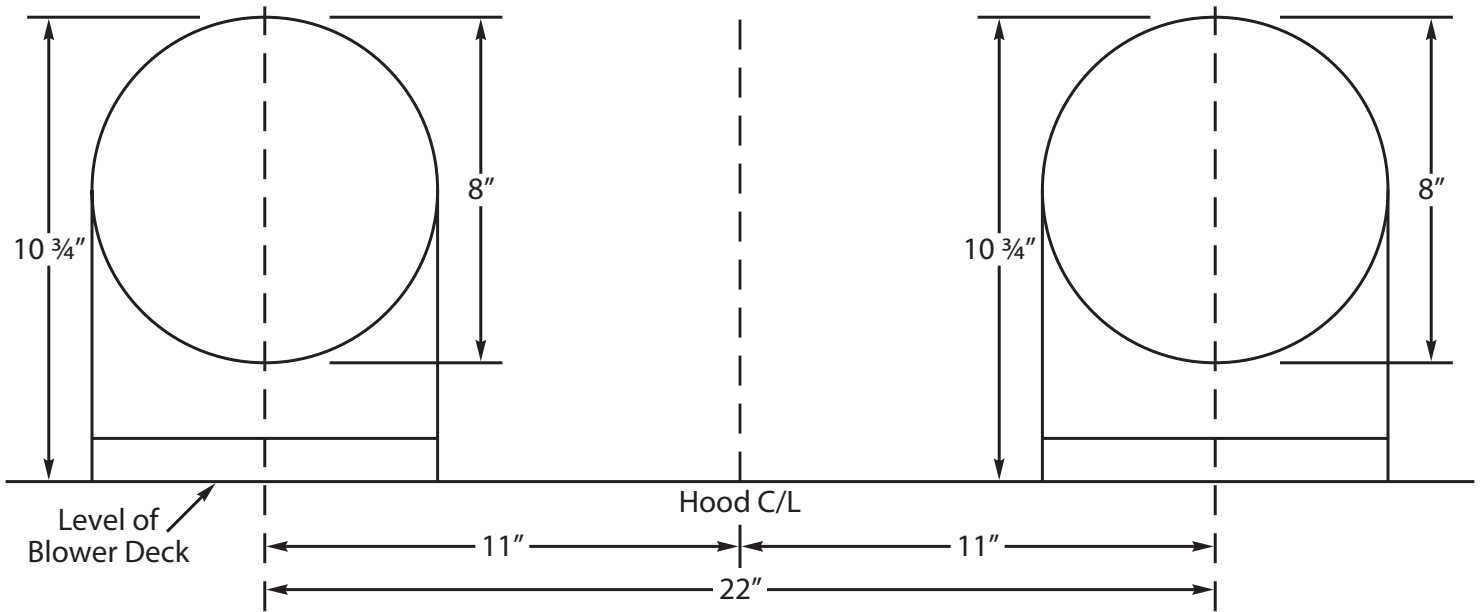

**B400 Blower Outlets With 2 VP515s
Installed (Back View)**

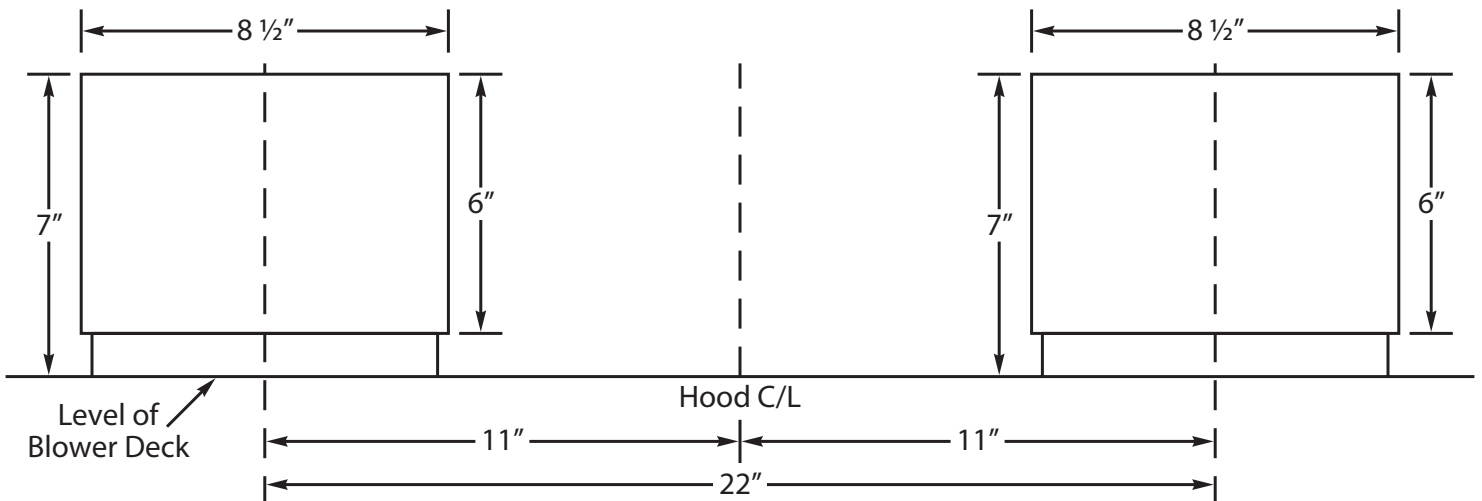

**B400 Blower Outlets With 2 VP561s
Installed (Back View)**